



P700WLS ioProx Receiver



Installation Manual



Warning! This manual contains information on limitations regarding product use and function and information on the limitations as to liability of the manufacturer. The entire manual should be carefully read.

Kantech Systems
Tel.: 1 (450) 444-2030
Toll Free (US & Canada): 1 888 222-1560
Fax: 1 (450) 444-2029
Web Site: www.kantech.com

© 2006 Tyco Safety Products, Canada, Ltd. All rights reserved. Specifications may be modified without notice.

Table of Contents

System Overview	1
Inventory	1
Technical Specifications	2
Installing the P700WLS IoProx Receiver	3
Global Coverage	3
Power Supply and Grounding.....	3
Recommended Wiring Distance at 12 Vdc.....	3
Data Path Selector Settings	4
Receiver Terminal Block Location.....	4
S1 Receiver Configuration	5
Receiver Wiring Diagrams.....	6
Testing the Receivers	7
PCB LED Indicators.....	7
Receiver Relay	8
Receiver Mounting Location	8
Testing the Transmitters	9
Operating Instructions.....	9
Troubleshooting	9
Replacing the Transmitter Battery.....	9

System Overview

The P700WLS loProx receiver unit is designed to interface with an access control panel card reader port using the Wiegand protocol or the Kantech eXtended Secure Format (XSF). The loprox receiver can read from a distance of up to 45.72 m. (150 ft.) with a power dipole antenna or 30.48 m. (100 ft.) with a standard antenna.

loprox transmitters come in two versions: with 2 or 4 buttons. And each can come with or without an integrated loProx key tag. The receiver unit receives the ID credentials from transmitters which consist of a site code and ID number. For increased security, the loprox transmitter uses incremental packet transmission so that a different transmission code is created every time the button is pressed, Transmitters with integrated loprox key tag also permit access to users when both loprox receivers and card readers are installed in different areas of the same building.

The receiver jumpers can be configured to determine which button on the key tag transmitter will activate the receiver. The same transmitter can be programmed to operate up to four different receivers (one per button) located within close proximity to each other (and to operate more receivers that are located farther apart.) The transmitter ID will only be sent to the access controller when a valid button is pressed.

Inventory

The P700WLS loprox receiver unit provides a reliable long-range wireless access control from a gate or an overhead door. Each unit is packed with:

- 1 P-WLS-A1 whip antenna
 - 4 enclosure fastening screws
- Mounting hardware is not provided.

Technical Specifications

P700WLS loProx Receiver		P72WLS/P74WLS Transmitters	
Power:	12-24 VDC	Power:	CR2032 3V lithium battery, included (3 year average lifetime)
Current:	50mA (stand-by) 100mA (peak)	Operating temperature:	0°C to 70°C (32°F to 158°F)
Output:	XSF or 26-bit Wiegand selectable	Dimensions (HWD) cm:	7.30 x 3.81 x 1.59
Operating temperature:	-30°C to 68°C (-22°F to 155°F)	Dimensions (HWD) in:	2.88 x 1.50 x 0.63
Dimensions (HWD) cm:	19.21 x 13.02 x 4.14	Certification:	FCC
Dimensions (HWD) in:	7.56 x 5.13 x 1.63	P-WLS-A1 Standard Whip Antenna	
Enclosure material:	Polycarbonate (HB) with UV stabilizer, weather-resistant, IP56, NEMA 4X rated	Read range:	Up to 12.20 m. (40 ft.)
Frequency:	433.92 MHz	Note:	Antenna P-WLS-A1 may be remotely installed using coaxial cable up to 4.5 m. (15 ft.)
Cable type:	3 twisted pairs, unshielded cable	P-WLS-A2 Power Dipole Antenna	
Maximum distance from controller at 12 VDC:	152 m (500 ft) with 18 AWG 112 m (369 ft) with 20 AWG 76 m (248 ft) with 22 AWG	Read range:	Up to 25 m. (80 ft.)
Certification:	FCC	Note:	Antenna P-WLS-A2 MUST be installed using coaxial cable up to 4.5 m. (15 ft.), RG1 1/U (Belden ref#8213) coaxial cable is recommended. Optional

Note: This equipment has been tested and found to comply with the limits for a Class B digital device, pursuant to part 15 of the FCC Rules. These limits are designed to provide reasonable protection against harmful interference in a residential installation. This equipment generates, uses and can radiate radio frequency energy and, if not installed and used in accordance with the instructions, may cause harmful interference to radio communications. However, there is no guarantee that interference will not occur in a particular installation. If this equipment does cause harmful interference to radio or television reception, which can be determined by turning the equipment off and on, the user is encouraged to try to correct the interference by one of more of the following measures:

- Reorient or relocate the receiving antenna.
- Increase the separation between the equipment and receiver.
- Connect the equipment into an outlet on a circuit different from that to which the receiver is connected.
- Consult the dealer or an experienced radio/TV technician for help.

This device complies with part 15 of the FCC rules. Operation is subject to the following two conditions:
 This device may not cause harmful interference, and
 This device must accept any interference received, including interference that may cause undesired operation.

Installing the P700WLS IoProx Receiver

Global Coverage

When global coverage of a large area is required, there should be a sufficient number of receivers to give overlapping coverage of receiving patterns.

Use the SW terminals if the receiver antennas are less than 30.5 m (100 ft) apart. The SW terminal connection prevents data clash at the control panel. (See Figure 2, Note 5 on page 6.)

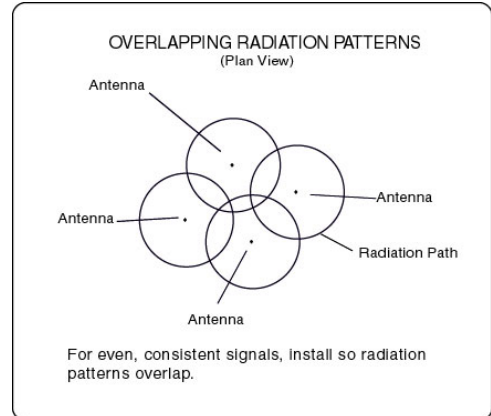

Power Supply and Grounding

Power requirements: 12-24 VDC, 50mA (stand-by), 100mA (peak). A linear type power supply is recommended if a separate power supply is used. Proper grounding gives an electrical charge, like an electrical static discharge or a near lightning strike, a path from which to dissipate its energy safely into the earth. It is strongly recommended to connect an earth ground wire to each receiver unit. (See Figure 2, Note 2 and Note 4 on page 6.)

Recommended Wiring Distance at 12 Vdc

<p>P700WLS receiver:</p>	<p>3 twisted pairs, unshielded cables</p> <ul style="list-style-type: none"> ▪ With #18 AWG: 152 m (500 ft) ▪ With #20 AWG: 112 m (369 ft) ▪ With #22 AWG: 76 m (248 ft)
---------------------------------	---

Data Path Selector Settings

The receiver unit provides for field selectable pins JP2 located near the center of the board (Figure 1)

Receiver Terminal Block Location

The receiver terminal block is removable. (Refer Figure 1) It can be mounted vertically or horizontally.

- Connect 22 to 14 AWG wires to the blue terminal block.

Figure 1 Terminal Block Location

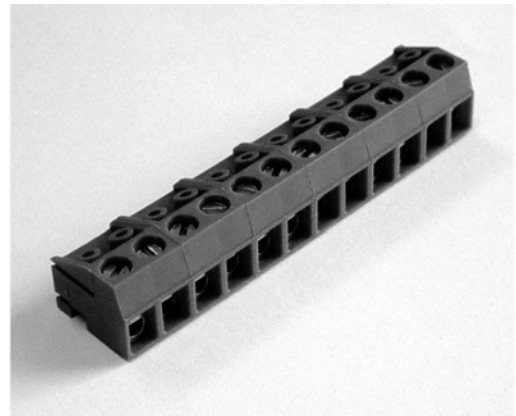
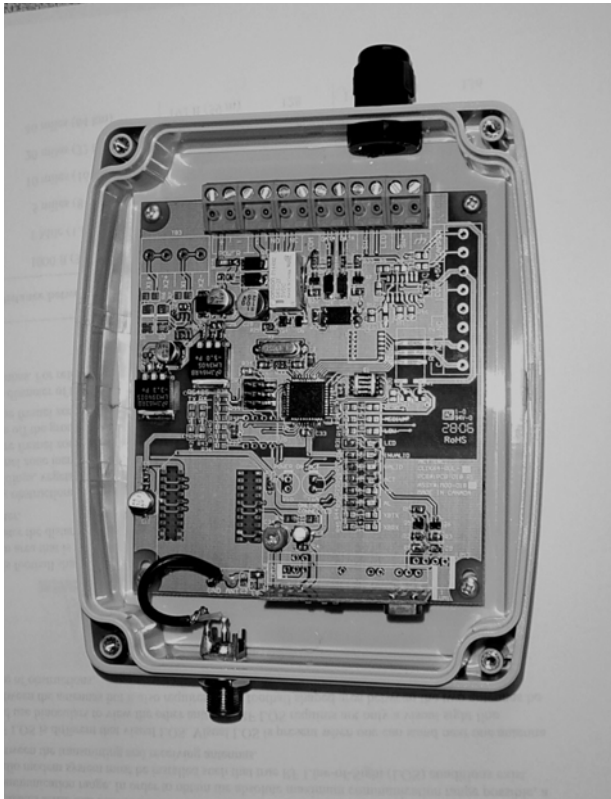

S1 Receiver Configuration

Placing the DIP switches in the ON or OFF position determines which specific button on the  multi-button transmitter will activate the receiver and Wiegand format to be transmitted to the control panel. (See Table 1 below)

Data Path Selector Settings:

- Kantech XSF (default): Position 4 (ON).
- 26-bit Wiegand: Position 4 (OFF).

Button 1

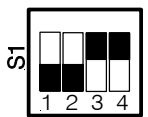

Button 3

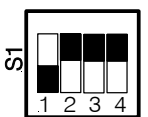

The selectors for position 1 and 2 select which of the four buttons will activate the receiver.

Button 2

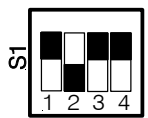

Button 4

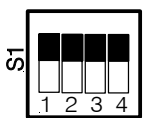

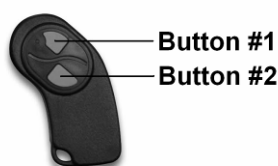

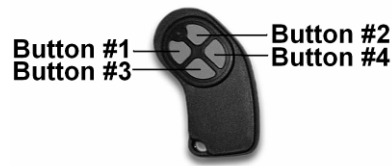

Format	Button	1	2	3	4
XSF	Button 1	OFF	OFF	ON	ON
	Button 2	OFF	ON	ON	ON
	Button 3	ON	OFF	ON	ON
	Button 4	ON	ON	ON	ON
26W	Button 1	OFF	OFF	ON	OFF
	Button 2	OFF	ON	ON	OFF
	Button 3	ON	OFF	ON	OFF
	Button 4	ON	ON	ON	OFF

Table 1 Data Path Selector Settings

Receiver Wiring Diagrams

Receiver - Typical Installation

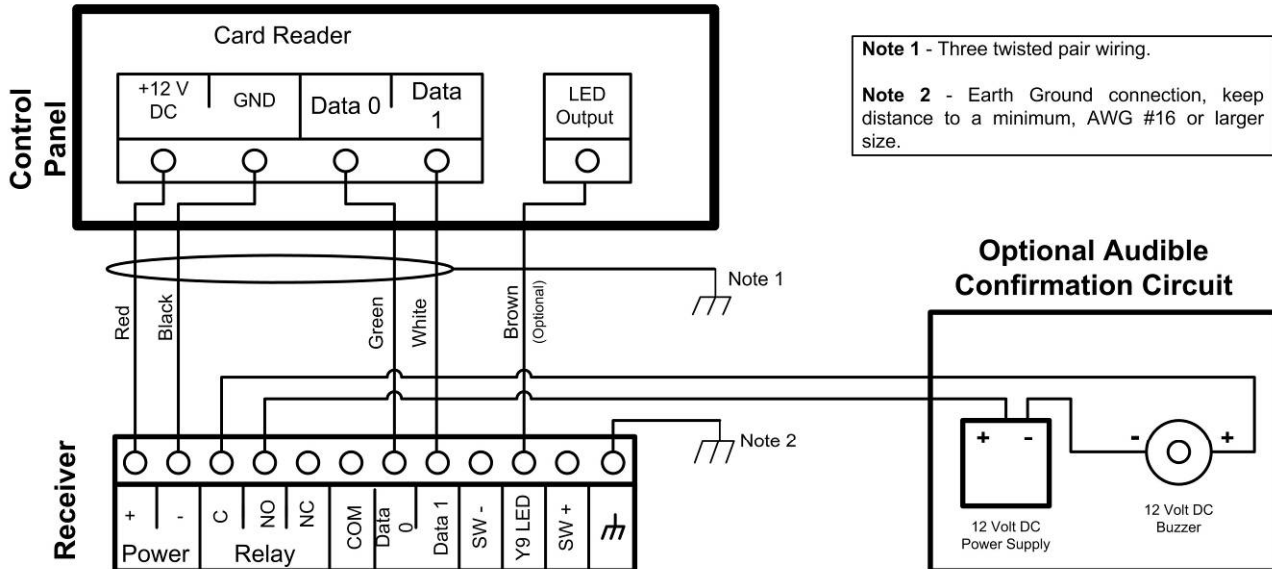

Two Receivers Connected to One Port

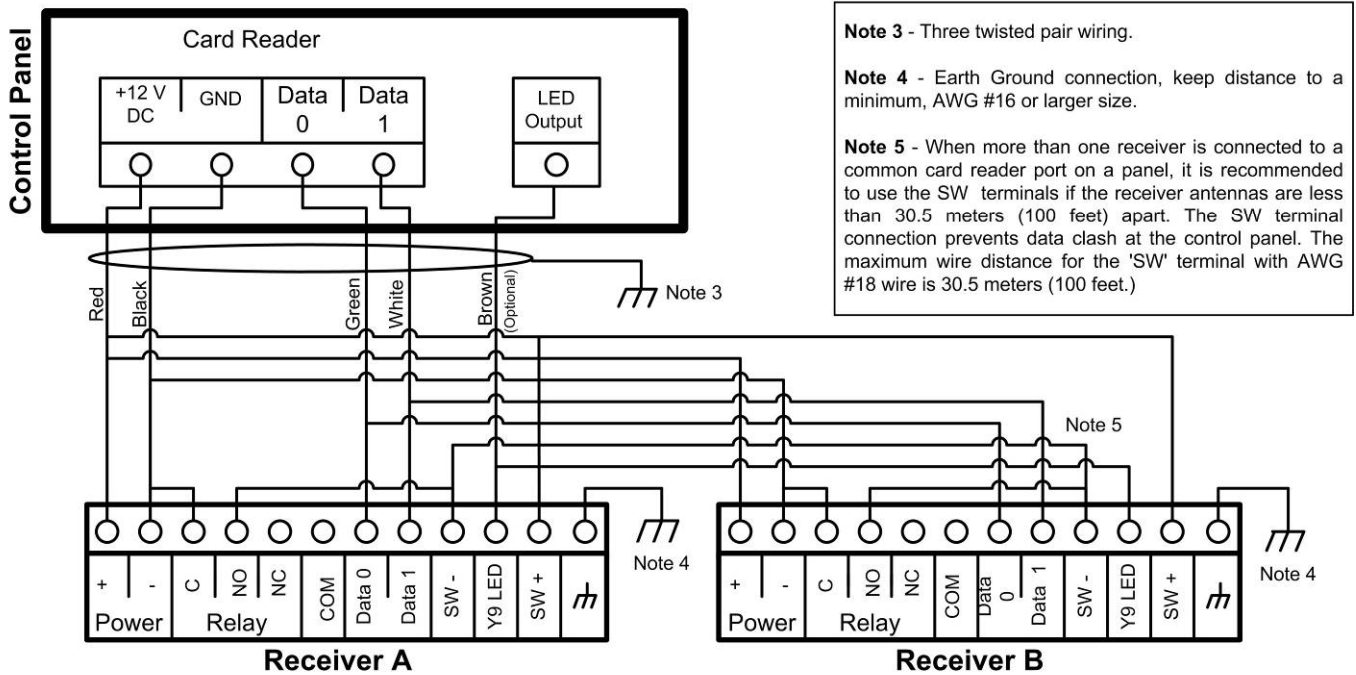

Note 6: All LEDs are located on the PC board, inside the box.

Figure 2 Typical Installation and Two Receivers Connected to One Port Installations

Testing the Receivers

PCB LED Indicators

All LEDs are located on the PC board, inside the box.

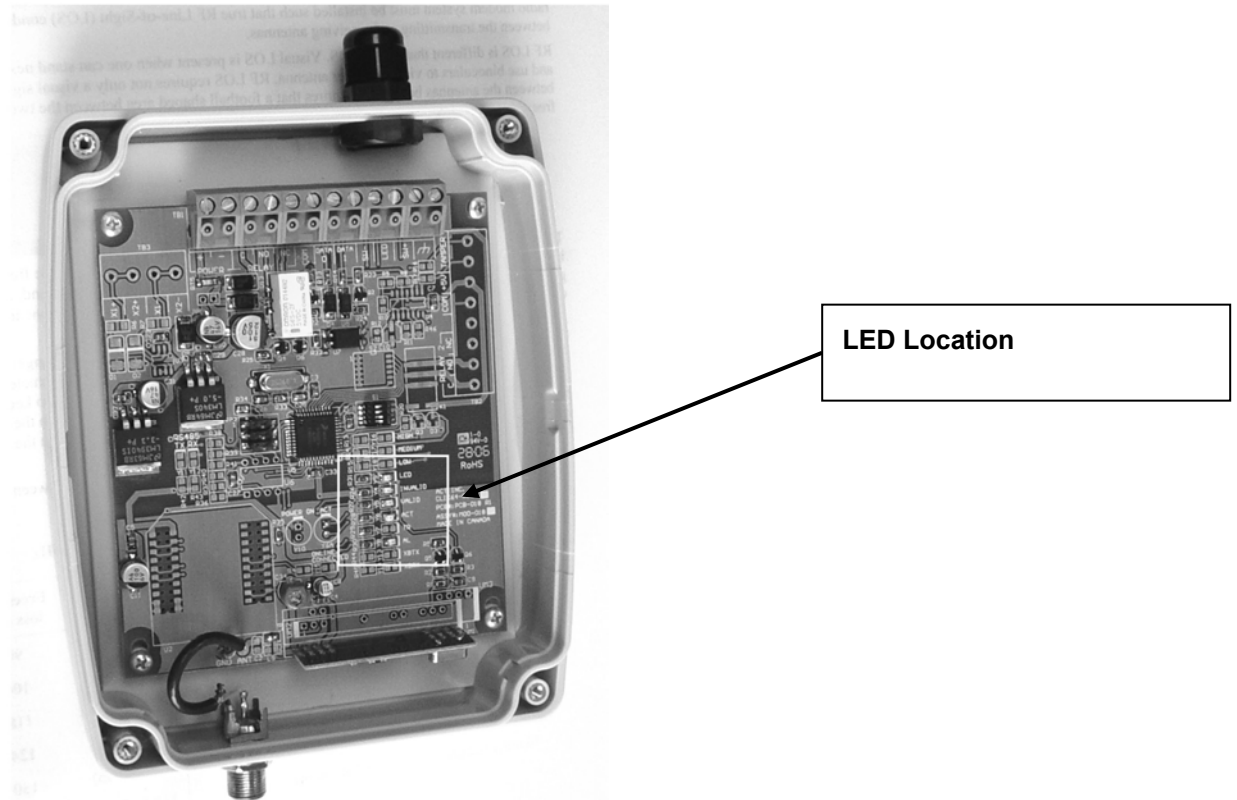

Figure 3 LEDs Location

- Y4:** Flashes if the transmitter encryption code does not match the receiver configuration, and will not operate the receiver. Check that the transmitters are programmed to operate with this receiver.
-
- Y5:** Flashes when the transmitter code is valid.
-
- Y6:** RF activity indicator. The LED will flicker to indicate the receiver has power. If the LED remains on steady, there is a continuous 433 MHz signal that will prevent the unit from operating reliably.
-
- Y8:** Flashes when the Wiegand information is sent.
-
- Y9:** Controlled externally by the access control panel. Typically this is controlled by the access control panels LED confirmation output (Brown wire). The Y9 LED is located on the PC board, inside the box.
-
- Y10** Power indicator.
-

Receiver Relay

The receiver relay activates for one second when a valid button on the transmitter triggers the receiver. The relay on the receiver can be used for testing purposes by adding an audible or visual device to confirm the receiver is receiving the signal consistently from the desired location of the transmitters.

Receiver Mounting Location

Antennas should be mounted as far away from the ceiling or wall as possible – a minimum of 10 cm (4 in) is required. For maximum range, mount antennas vertically, as high as possible and in line of sight. The location should offer protection from vandalism.

The receiver unit can also be mounted flush with a wall or ceiling if the antenna is remotely connected with a coaxial patch cord and mounted 10 cm. (4 in.) from the wall or ceiling surface. (Refer to Figure 4). Limit the length of the 75-ohm coaxial cable (RG-11/U) to less than 4.5 m. (15 ft.) and use weatherproof F-connectors if mounting the cable outside. Water droplets accumulating inside an F-connector will short out the cable. For best performance, mount the antenna vertically.



DO NOT mount receiver and antenna near any source of interference (i.e. proximity card readers, other RF receivers, motors, etc) or metal structures (i.e. pipes). The greater the height and distance between the antenna and the source of interference the better – a minimum of 2.4 m (8 ft) is recommended. Installing antennas too close to an electrical source will affect performance.

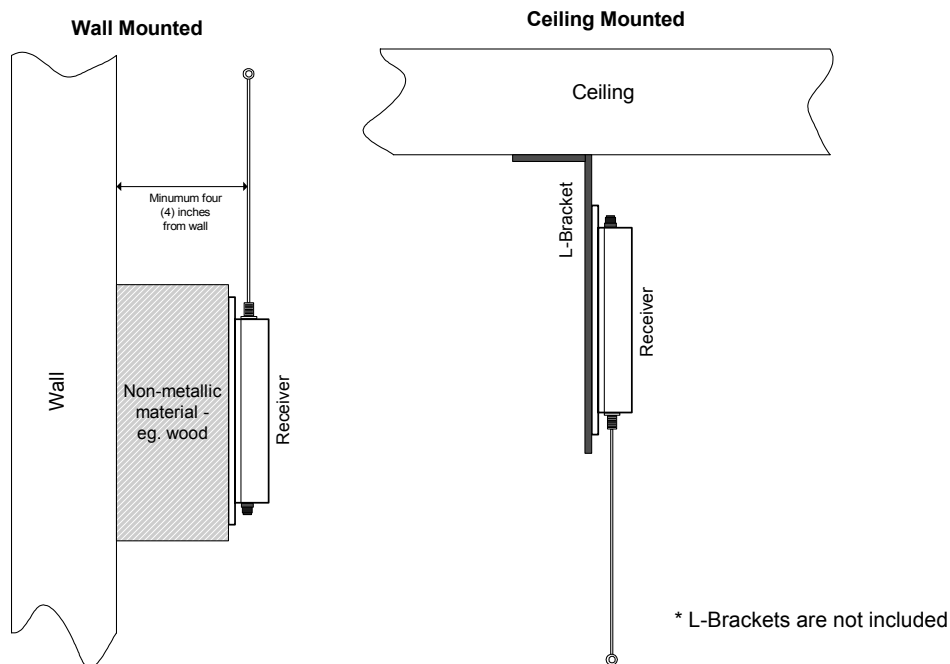

Figure 4 Wall and Ceiling Mounted Receivers

Testing the Transmitters

Operating Instructions

The following instructions can be used for both models (2 or 4 buttons)

1. On the key tag transmitter, press for one (1) second the button you programmed earlier to activate the receiver. A red indicator light will flash for the duration of the transmission.

Note: Pressing and holding the button down only transmits a short pulse.

2. Release and press the button again to send another transmission.
3. If the light on the transmitter does not light up when you press any of the buttons, replace the battery.

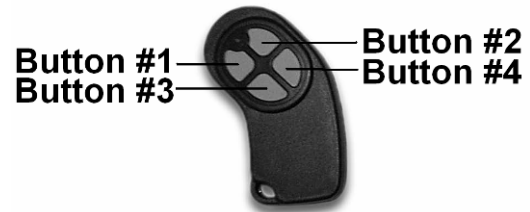
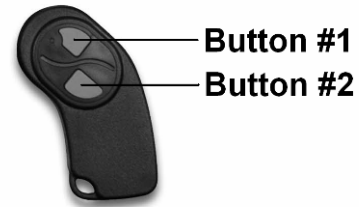

Troubleshooting

Replacing the Transmitter Battery

Tools required:

Flat edge tool or screwdriver

Battery model CR2032

1. Before you start, make sure the case is laid flat on the table and upside down.
2. From the key ring corner, use a flat edge tool or screwdriver to carefully pry open the case.
3. Push the coin shaped battery out of its holder and replace it with a similar battery being careful to place the positive (+) side on top.



DO NOT install the battery backwards. It will damage the device.

4. Close the case. You will hear a snap that indicates the case is closed.
5. Test the transmitter and observe the red flashing light at the front when pressing a button.