

PC1404 v1.0 Installation Guide

PowerSeries™
SECURITY SYSTEM

WARNING: This manual contains information on limitations regarding product use and function and information on the limitations as to liability of the manufacturer. The entire manual should be carefully read.

SAFETY INSTRUCTIONS for SERVICE PERSONNEL

WARNING: When using equipment connected to the TELEPHONE NETWORK, there are basic safety instructions that should always be followed. Refer to the SAFETY INSTRUCTIONS provided with this product; save them for (future) reference. Instruct the end-user regarding the safety precautions that shall be observed when operating this equipment.

Before Installing The Equipment

Ensure your package includes the following items:

- Installation and User Manuals
- PC1404 alarm controller
- Power supply, direct plug-in
- Mounting hardware

READ and SAVE These Instructions!

Follow All WARNINGS AND INSTRUCTIONS specified within this document and/or on the equipment.

Selecting A Suitable Location For The Alarm Controller

Use the following list as a guide to find a suitable place for this equipment:

- Locate near a telephone socket and power outlet.
- Select a place free from vibration and shocks.
- Place the alarm controller on a flat, stable surface and follow the installation instructions.

DO NOT locate this product where persons may walk on the secondary circuit cable(s).

DO NOT connect the alarm controller to electrical outlets on the same circuit as large appliances.

DO NOT select a place that exposes your alarm controller to direct sunlight, excessive heat, moisture, vapors, chemicals or dust.

DO NOT install this equipment near water. (e.g., bath tub, wash bowl, kitchen/laundry sink, wet basement, near a swimming pool).

DO NOT install this equipment and its accessories in areas where there is a risk of explosion.

DO NOT connect this equipment to electrical outlets controlled by wall switches or automatic timers;

AVOID interference sources.

AVOID setting up the equipment near heaters, air conditioners, ventilators, and/or refrigerators.

AVOID locating this equipment close to or on top of large metal objects (e.g., metal wall studs).

SAFETY Precautions Required During Installation

- **NEVER** install this equipment and/or telephone wiring during a lightning storm.
- **NEVER** touch uninsulated telephone wires or terminals unless the telephone line has been disconnected at the network interface.
- Position cables so that accidents cannot occur. Connected cables must NOT be subject to excessive mechanical strain.
- Use only the power supply provided with this equipment. Use of unauthorized power supplies may cause damage.
- For direct plug-in versions, use the transformer supplied with the device.

WARNING: THIS EQUIPMENT, WHEN POWERED VIA DIRECT PLUG-IN TRANSFORMER, HAS NO MAINS ON/OFF SWITCH. THE PLUG OF THE DIRECT PLUG-IN POWER SUPPLY IS INTENDED TO SERVE AS THE DISCONNECTING DEVICE IF THE EQUIPMENT MUST BE QUICKLY DISCONNECTED. IT IS IMPERATIVE THAT ACCESS TO THE MAINS PLUG AND ASSOCIATED MAINS SOCKET/OUTLET IS NEVER OBSTRUCTED.

IMPORTANT NOTE!

This equipment, alarm controller PC1404, shall be installed and used within an environment that provides the pollution degree max 2 and over-voltages category II NON-HAZARDOUS LOCATIONS, indoor only. The equipment is FIXED and PERMANENTLY CONNECTED and is designed to be installed, serviced and/or repaired by service persons only; [service person is defined as a person having the appropriate technical training and experience necessary to be aware of hazards to which that person may be exposed in performing a task and of measures to minimize the risks to that person or other persons]. There are no parts replaceable by the end-user within this equipment. The wiring (cables) used for installation of the Alarm System and accessories shall be insulated with PVC, TFE, PTFE, FEP, Neoprene or Polyamide.

- a) The equipment enclosure must be secured to the building structure before operation.
- b) Internal wiring must be routed in a manner that prevents
 - excessive strain or loosening of wire on terminal connections;

- damage of conductor insulation.
- c) Disposal of used batteries shall be made in accordance with local waste recovery and recycling regulations.
- d) Before servicing, DISCONNECT the power and telephone connection.
- e) DO NOT route any wiring over circuit boards. Maintain at least 1" (25.4 mm) separation.
- f) It is the installer's responsibility to ensure that a readily accessible disconnect device is incorporated in the building for permanently connected installations.
- g) The connection to the mains supply must be made as per the local authorities' rules and regulations. An appropriate disconnect device must be provided as part of the building installation. Where it is not possible to rely on identification of the neutral in the AC Mains supply, the disconnecting device must disconnect both poles simultaneously (line and neutral). The device shall disconnect the supply during servicing.

The power supply must be Class II, FAIL SAFE with double or reinforced insulation between the PRIMARY and SECONDARY circuit/ ENCLOSURE and be an approved type acceptable to the local authorities. All national wiring rules shall be observed.

Guidelines for Locating Smoke & CO Detectors

The following information is for general guidance only and it is recommended that local fire codes and regulations be consulted when locating and installing smoke and CO alarms.

Smoke Detectors

Research indicates that all hostile fires in homes generate smoke to a greater or lesser extent. Detectable quantities of smoke precede detectable levels of heat in most cases. Smoke alarms should be installed outside of each sleeping area and on each storey of the home. DSC recommends that additional smoke alarms beyond those required for minimum protection be installed. Additional areas that should be protected include: the basement; bedrooms, especially where smokers sleep; dining rooms; furnace and utility rooms; and any hallways not protected by the required units.

On smooth ceilings, detectors may be spaced 9.1m (30 feet) apart as a guide. Other spacing may be required depending on ceiling height, air movement, the presence of joists, uninsulated ceilings, etc. Consult National Fire Alarm Code NFPA 72, CAN/ULC-S553-02 or other appropriate national standards for installation recommendations.

- Do not locate smoke detectors at the top of peaked or gabled ceilings; dead air space in these locations may prevent smoke detection.
- Avoid areas with turbulent air flow, such as near doors, fans or windows. Rapid air movement around the detector may prevent smoke from entering the unit.
- Do not locate detectors in areas of high humidity.
- Do not locate detectors in areas where the temperature rises above 38°C (100°F) or falls below 5°C (41°F).
- Smoke detectors should always be installed in accordance with NFPA 72, the National Fire Alarm Code. Smoke detectors should always be located in accordance with:

“Smoke detectors shall be installed outside of each separate sleeping area in the immediate vicinity of the bedrooms and on each additional storey of the family living unit, including basements and excluding crawl spaces and unfinished attics. In new construction, a smoke detector shall also be installed in each sleeping room.” Split level arrangement: Smoke detectors are required where shown. Smoke detectors are optional where a door is not provided between living room and recreation room.

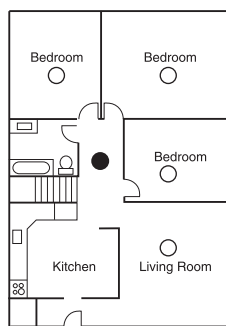

Figure 1

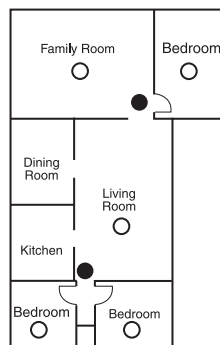
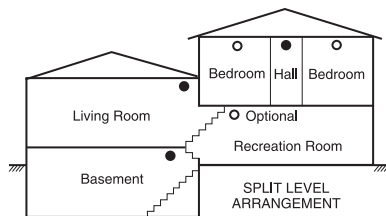

Figure 2



- Smoke detectors for better protection
- Smoke detectors for minimum protection

Figure 3a

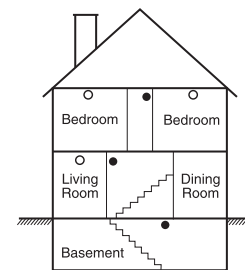

Figure 3

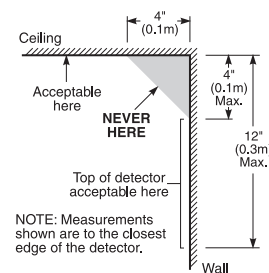

Figure 4

CO Detectors

CO gas moves freely in the air. The human body is most vulnerable to the effects of CO gas during sleeping hours. For maximum protection, a CO alarm should be located outside primary sleeping areas or on each level of your home. Figure 5 indicates the suggested locations in the home. The electronic sensor detects carbon monoxide, measures the concentration and sounds a loud alarm before a potentially harmful level is reached.

Do **NOT** place the CO alarm in the following areas:

- Where the temperature may drop below -10°C or exceed 40 °C.
- Near paint thinner fumes.
- Within 5 feet (1.5 meters) of open flame appliances such as furnaces, stoves and fireplaces.
- In exhaust streams from gas engines, vents, flues or chimneys.
- Do not place in close proximity to an automobile exhaust pipe; this will damage the detector.

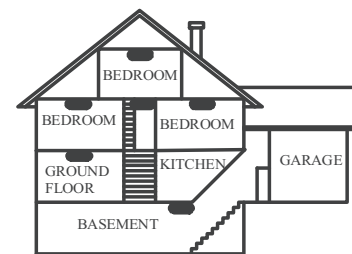

- CARBON MONOXIDE DETECTOR

Figure 5

Limited Warranty

Digital Security Controls warrants the original purchaser that for a period of twelve months from the date of purchase, the product shall be free of defects in materials and workmanship under normal use. During the warranty period, Digital Security Controls shall, at its option, repair or replace any defective product upon return of the product to its factory, at no charge for labour and materials. Any replacement and/or repaired parts are warranted for the remainder of the original warranty or ninety (90) days, whichever is longer. The original purchaser must promptly notify Digital Security Controls in writing that there is a defect in material or workmanship, such written notice to be received in all events prior to expiration of the warranty period. There is absolutely no warranty on software and all software products are sold as a user license under the terms of the software license agreement included with the product. The Customer assumes all responsibility for the proper selection, installation, operation and maintenance of any products purchased from DSC. Custom products are only warranted to the extent that they do not function upon delivery. In such cases, DSC can repair or credit at its option.

International Warranty

The warranty for international customers is the same as for any customer within Canada and the United States, with the exception that Digital Security Controls shall not be responsible for any customs fees, taxes, or VAT that may be due.

Warranty Procedure

To obtain service under this warranty, please return the item(s) in question to the point of purchase. All authorized distributors and dealers have a warranty program. Anyone returning goods to Digital Security Controls must first obtain an authorization number. Digital Security Controls will not accept any shipment whatsoever for which prior authorization has not been obtained.

Conditions to Void Warranty

This warranty applies only to defects in parts and workmanship relating to normal use. It does not cover:

- damage incurred in shipping or handling;
- damage caused by disaster such as fire, flood, wind, earthquake or lightning;
- damage due to causes beyond the control of Digital Security Controls such as excessive voltage, mechanical shock or water damage;
- damage caused by unauthorized attachment, alterations, modifications or foreign objects;
- damage caused by peripherals (unless such peripherals were supplied by Digital Security Controls Ltd.);
- defects caused by failure to provide a suitable installation environment for the products;
- damage caused by use of the products for purposes other than those for which it was designed;
- damage from improper maintenance;
- damage arising out of any other abuse, mishandling or improper application of the products.

Note to Installers

This warning contains vital information. As the only individual in contact with system users, it is your responsibility to bring each item in this warning to the attention of the users of this system.

System Failures

This system has been carefully designed to be as effective as possible. There are circumstances, however, involving fire, burglary, or other types of emergencies where it may not provide protection. Any alarm system of any type may be compromised deliberately or may fail to operate as expected for a variety of reasons. Some but not all of these reasons may be:

• Inadequate Installation

A security system must be installed properly in order to provide adequate protection. Every installation should be evaluated by a security professional to ensure that all access points and areas are covered. Locks and latches on windows and doors must be secure and operate as intended. Windows, doors, walls, ceilings and other building materials must be of sufficient strength and construction to provide the level of protection expected. A reevaluation must be done during and after any construction activity. An evaluation by the fire and/or police department is highly recommended if this service is available.

• Criminal Knowledge

This system contains security features which were known to be effective at the time of manufacture. It is possible for persons with criminal intent to develop techniques which reduce the effectiveness of these features. It is important that a security system be reviewed periodically to ensure that its features remain effective and that it be updated or replaced if it is found that it does not provide the protection expected.

• Access by Intruders

Intruders may enter through an unprotected access point, circumvent a sensing device, evade detection by moving through an area of insufficient coverage, disconnect a warning device, or interfere with or prevent the proper operation of the system.

• Power Failure

Control units, intrusion detectors, smoke detectors and many other security devices require an adequate power supply for proper operation. If a device operates from batteries, it is possible for the batteries to fail. Even if the batteries have not failed, they must be charged, in good condition and installed correctly. If a device operates only by AC power, any interruption, however brief, will render that device inoperative while it does not have power. Power interruptions of any length are often accompanied by voltage fluctuations which may damage electronic equipment such as a security system. After a power interruption has occurred, immediately conduct a complete system test to ensure that the system operates as intended.

• Failure of Replaceable Batteries

This system's wireless transmitters have been designed to provide several years of battery life under normal conditions. The expected battery life is a function of the device environment, usage and type. Ambient conditions such as high humidity, high or low temperatures, or large temperature fluctuations may reduce the expected battery life. While each transmitting device has a low battery monitor which identifies when the batteries need to be replaced, this monitor may fail to operate as expected. Regular testing and maintenance will keep the system in good operating condition.

• Compromise of Radio Frequency (Wireless) Devices

Signals may not reach the receiver under all circumstances which could include metal objects placed on or near the radio path or deliberate jamming or other inadvertent radio signal interference.

• System Users

A user may not be able to operate a panic or emergency switch possibly due to permanent or temporary physical disability, inability to reach the device in time, or unfamiliarity with the correct operation. It is important that all system users be trained in the correct operation of the alarm system and that they know how to respond when the system indicates an alarm.

IMPORTANT - READ CAREFULLY: DSC Software purchased with or without Products and Components is copyrighted and is purchased under the following license terms:

- This End-User License Agreement ("EULA") is a legal agreement between You (the company, individual or entity who acquired the Software and any related Hardware) and Digital Security Controls, a division of Tyco Safety Products Canada Ltd. ("DSC"), the manufacturer of the integrated security systems and the developer of the software and any related products or components ("HARDWARE") which You acquired.
- If the DSC software product ("SOFTWARE PRODUCT" or "SOFTWARE") is intended to be accompanied by HARDWARE, and is NOT accompanied by new HARDWARE, You may not use, copy or install the SOFTWARE PRODUCT. The SOFTWARE PRODUCT includes computer software, and may include associated media, printed materials, and "online" or electronic documentation.
- Any software provided along with the SOFTWARE PRODUCT that is associated with a separate end-user license agreement is licensed to You under the terms of that license agreement.
- By installing, copying, downloading, storing, accessing or otherwise using the SOFTWARE PRODUCT, You agree unconditionally to be bound by the terms of this EULA, even if this EULA is deemed to be a modification of any previous arrangement or contract. If You do not agree to the terms of this EULA, DSC is unwilling to license the SOFTWARE PRODUCT to You, and You have no right to use it.

SOFTWARE PRODUCT LICENSE

The SOFTWARE PRODUCT is protected by copyright laws and international copyright treaties, as well as other intellectual property laws and treaties. The SOFTWARE PRODUCT is licensed, not sold.

1. GRANT OF LICENSE This EULA grants You the following rights:

- Software Installation and Use - For each license You acquire, You may have only one copy of the SOFTWARE PRODUCT installed.
- Storage/Network Use - The SOFTWARE PRODUCT may not be installed, accessed, displayed, run, shared or used concurrently on or from different computers, including a workstation, terminal or other digital electronic device ("Device"). In other words, if You have several workstations, You will have to acquire a license for each workstation where the SOFTWARE will be used.
- Backup Copy - You may make back-up copies of the SOFTWARE PRODUCT, but You may only have one copy per license installed at any given time. You may use the back-up copy solely for archival purposes. Except as expressly provided in this EULA, You may not otherwise make copies of the SOFTWARE PRODUCT, including the printed materials accompanying the SOFTWARE.

2. DESCRIPTION OF OTHER RIGHTS AND LIMITATIONS

- Limitations on Reverse Engineering, Decompilation and Disassembly - You may not reverse engineer, decompile, or disassemble the SOFTWARE PRODUCT, except and only to the extent that such activity is expressly permitted by applicable law notwithstanding this limitation. You may not make any changes or modifications to the Software, without the written permission of an officer of DSC. You may not remove any proprietary notices, marks or labels from the Software Product. You shall institute reasonable measures to ensure compliance with the terms and conditions of this EULA.
- Separation of Components - The SOFTWARE PRODUCT is licensed as a single product. Its component parts may not be separated for use on more than one HARDWARE unit.
- Single INTEGRATED PRODUCT - If You acquired this SOFTWARE with HARDWARE, then the SOFTWARE PRODUCT is licensed with the HARDWARE as a single integrated product. In this case, the SOFTWARE PRODUCT may only be used with the HARDWARE as set forth in this EULA.
- Rental - You may not rent, lease or lend the SOFTWARE PRODUCT. You may not make it available to others or post it on a server or web site.
- Software Product Transfer - You may transfer all of Your rights under this EULA only as part of a permanent sale or transfer of the HARDWARE, provided You retain no copies, You transfer all of the SOFTWARE PRODUCT (including all component parts, the media and printed materials, any upgrades and this EULA), and provided the recipient agrees to the terms of this EULA. If the SOFTWARE PRODUCT is an upgrade, any transfer must also include all prior versions of the SOFTWARE PRODUCT.

Items Not Covered by Warranty

In addition to the items which void the Warranty, the following items shall not be covered by Warranty: (i) freight cost to the repair centre; (ii) products which are not identified with DSC's product label and lot number or serial number; (iii) products disassembled or repaired in such a manner as to adversely affect performance or prevent adequate inspection or testing to verify any warranty claim. Access cards or tags returned for replacement under warranty will be credited or replaced at DSC's option. Products not covered by this warranty, or otherwise out of warranty due to age, misuse, or damage shall be evaluated, and a repair estimate shall be provided. No repair work will be performed until a valid purchase order is received from the Customer and a Return Merchandise Authorization number (RMA) is issued by DSC's Customer Service. Digital Security Controls Ltd.'s liability for failure to repair the product under this warranty after a reasonable number of attempts will be limited to a replacement of the product, as the exclusive remedy for breach of warranty. Under no circumstances shall Digital Security Controls be liable for any special, incidental, or consequential damages based upon breach of warranty, breach of contract, negligence, strict liability, or any other legal theory. Such damages include, but are not limited to, loss of profits, loss of the product or any associated equipment, cost of capital, cost of substitute or replacement equipment, facilities or services, down time, purchaser's time, the claims of third parties, including customers, and injury to property. The laws of some jurisdictions limit or do not allow the disclaimer of consequential damages. If the laws of such a jurisdiction apply to any claim by or against DSC, the limitations and disclaimers contained here shall be to the greatest extent permitted by law. Some states do not allow the exclusion or limitation of incidental or consequential damages, so that the above may not apply to you.

Disclaimer of Warranties

This warranty contains the entire warranty and shall be in lieu of any and all other warranties, whether expressed or implied (including all implied warranties of merchantability or fitness for a particular purpose) and of all other obligations or liabilities on the part of Digital Security Controls. Digital Security Controls neither assumes responsibility for, nor authorizes any other person purporting to act on its behalf to modify or to change this warranty, nor to assume for it any other warranty or liability concerning this product. This disclaimer of warranties and limited warranty are governed by the laws of the province of Ontario, Canada.

WARNING: Digital Security Controls recommends that the entire system be completely tested on a regular basis. However, despite frequent testing, and due to, but not limited to, criminal tampering or electrical disruption, it is possible for this product to fail to perform as expected.

Out of Warranty Repairs

Digital Security Controls will at its option repair or replace out-of-warranty products which are returned to its factory according to the following conditions. Anyone returning goods to Digital Security Controls must first obtain an authorization number. Digital Security Controls will not accept any shipment whatsoever for which prior authorization has not been obtained.

Products which Digital Security Controls determines to be repairable will be repaired and returned. A set fee which Digital Security Controls has predetermined and which may be revised from time to time, will be charged for each unit repaired.

Products which Digital Security Controls determines not to be repairable will be replaced by the nearest equivalent product available at that time. The current market price of the replacement product will be charged for each replacement unit.

WARNING - READ CAREFULLY

• Smoke Detectors

Smoke detectors that are a part of this system may not properly alert occupants of a fire for a number of reasons, some of which follow. The smoke detectors may have been improperly installed or positioned. Smoke may not be able to reach the smoke detectors, such as when the fire is in a chimney, walls or roofs, or on the other side of closed doors. Smoke detectors may not detect smoke from fires on another level of the residence or building.

Every fire is different in the amount of smoke produced and the rate of burning. Smoke detectors cannot sense all types of fires equally well. Smoke detectors may not provide timely warning of fires caused by carelessness or safety hazards such as smoking in bed, violent explosions, escaping gas, improper storage of flammable materials, overloaded electrical circuits, children playing with matches or arson.

Even if the smoke detector operates as intended, there may be circumstances when there is insufficient warning to allow all occupants to escape in time to avoid injury or death.

• Motion Detectors

Motion detectors can only detect motion within the designated areas as shown in their respective installation instructions. They cannot discriminate between intruders and intended occupants. Motion detectors do not provide volumetric area protection. They have multiple beams of detection and motion can only be detected in unobstructed areas covered by these beams. They cannot detect motion which occurs behind walls, ceilings, floor, closed doors, glass partitions, glass doors or windows. Any type of tampering whether intentional or unintentional such as masking, painting, or spraying of any material on the lenses, mirrors, windows or any other part of the detection system will impair its proper operation.

Passive infrared motion detectors operate by sensing changes in temperature. However their effectiveness can be reduced when the ambient temperature rises near or above body temperature or if there are intentional or unintentional sources of heat in or near the detection area. Some of these heat sources could be heaters, radiators, stoves, barbecues, fireplaces, sunlight, steam vents, lighting and so on.

• Warning Devices

Warning devices such as sirens, bells, horns, or strobes may not warn people or awaken someone sleeping if there is an intervening wall or door. If warning devices are located on a different level of the residence or premise, then it is less likely that the occupants will be alerted or awakened. Audible warning devices may be interfered with by other noise sources such as stereos, radios, televisions, air conditioners or other appliances, or passing traffic. Audible warning devices, however loud, may not be heard by a hearing-impaired person.

• Telephone Lines

If telephone lines are used to transmit alarms, they may be out of service or busy for certain periods of time. Also an intruder may cut the telephone line or defeat its operation by more sophisticated means which may be difficult to detect.

• Insufficient Time

There may be circumstances when the system will operate as intended, yet the occupants will not be protected from the emergency due to their inability to respond to the warnings in a timely manner. If the system is monitored, the response may not occur in time to protect the occupants or their belongings.

• Component Failure

Although every effort has been made to make this system as reliable as possible, the system may fail to function as intended due to the failure of a component.

• Inadequate Testing

Most problems that would prevent an alarm system from operating as intended can be found by regular testing and maintenance. The complete system should be tested weekly and immediately after a break-in, an attempted break-in, a fire, a storm, an earthquake, an accident, or any kind of construction activity inside or outside the premises. The testing should include all sensing devices, keypads, consoles, alarm indicating devices and any other operational devices that are part of the system.

• Security and Insurance

Regardless of its capabilities, an alarm system is not a substitute for property or life insurance. An alarm system also is not a substitute for property owners, renters, or other occupants to act prudently to prevent or minimize the harmful effects of an emergency situation.

- Termination - Without prejudice to any other rights, DSC may terminate this EULA if You fail to comply with the terms and conditions of this EULA. In such event, You must destroy all copies of the SOFTWARE PRODUCT and all of its component parts.
- Trademarks - This EULA does not grant You any rights in connection with any trademarks or service marks of DSC or its suppliers.

3. COPYRIGHT - All title and intellectual property rights in and to the SOFTWARE PRODUCT (including but not limited to any images, photographs, and text incorporated into the SOFTWARE PRODUCT), the accompanying printed materials, and any copies of the SOFTWARE PRODUCT, are owned by DSC or its suppliers. You may not copy the printed materials accompanying the SOFTWARE PRODUCT. All title and intellectual property rights in and to the content which may be accessed through use of the SOFTWARE PRODUCT are the property of the respective content owner and may be protected by applicable copyright or other intellectual property laws and treaties. This EULA grants You no rights to use such content. All rights not expressly granted under this EULA are reserved by DSC and its suppliers.

4. EXPORT RESTRICTIONS - You agree that You will not export or re-export the SOFTWARE PRODUCT to any country, person, or entity subject to Canadian export restrictions.

5. CHOICE OF LAW - This Software License Agreement is governed by the laws of the Province of Ontario, Canada.

6. ARBITRATION - All disputes arising in connection with this Agreement shall be determined by final and binding arbitration in accordance with the Arbitration Act, and the parties agree to be bound by the arbitrator's decision. The place of arbitration shall be Toronto, Canada, and the language of the arbitration shall be English.

7. LIMITED WARRANTY

- NO WARRANTY - DSC PROVIDES THE SOFTWARE "AS IS" WITHOUT WARRANTY. DSC DOES NOT WARRANT THAT THE SOFTWARE WILL MEET YOUR REQUIREMENTS OR THAT OPERATION OF THE SOFTWARE WILL BE UNINTERRUPTED OR ERROR-FREE.
- CHANGES IN OPERATING ENVIRONMENT - DSC shall not be responsible for problems caused by changes in the operating characteristics of the HARDWARE, or for problems in the interaction of the SOFTWARE PRODUCT with non-DSC SOFTWARE or HARDWARE PRODUCTS.
- LIMITATION OF LIABILITY; WARRANTY REFLECTS ALLOCATION OF RISK - IN ANY EVENT, IF ANY STATUTE IMPLIES WARRANTIES OR CONDITIONS NOT STATED IN THIS LICENSE AGREEMENT, DSC'S ENTIRE LIABILITY UNDER ANY PROVISION OF THIS LICENSE AGREEMENT SHALL BE LIMITED TO THE GREATER OF THE AMOUNT ACTUALLY PAID BY YOU TO LICENSE THE SOFTWARE PRODUCT AND FIVE CANADIAN DOLLARS (CAD\$5.00). BECAUSE SOME JURISDICTIONS DO NOT ALLOW THE EXCLUSION OR LIMITATION OF LIABILITY FOR CONSEQUENTIAL OR INCIDENTAL DAMAGES, THE ABOVE LIMITATION MAY NOT APPLY TO YOU.
- DISCLAIMER OF WARRANTIES - THIS WARRANTY CONTAINS THE ENTIRE WARRANTY AND SHALL BE IN LIEU OF ANY AND ALL OTHER WARRANTIES, WHETHER EXPRESSED OR IMPLIED (INCLUDING ALL IMPLIED WARRANTIES OF MERCHANTABILITY OR FITNESS FOR A PARTICULAR PURPOSE) AND OF ALL OTHER OBLIGATIONS OR LIABILITIES ON THE PART OF DSC. DSC MAKES NO OTHER WARRANTIES. DSC NEITHER ASSUMES NOR AUTHORIZES ANY OTHER PERSON PURPORTING TO ACT ON ITS BEHALF TO MODIFY OR TO CHANGE THIS WARRANTY, NOR TO ASSUME FOR IT ANY OTHER WARRANTY OR LIABILITY CONCERNING THIS SOFTWARE PRODUCT.
- EXCLUSIVE REMEDY AND LIMITATION OF WARRANTY - UNDER NO CIRCUMSTANCES SHALL DSC BE LIABLE FOR ANY SPECIAL, INCIDENTAL, CONSEQUENTIAL OR INDIRECT DAMAGES BASED UPON BREACH OF WARRANTY, BREACH OF CONTRACT, NEGLIGENCE, STRICT LIABILITY, OR ANY OTHER LEGAL THEORY. SUCH DAMAGES INCLUDE, BUT ARE NOT LIMITED TO, LOSS OF PROFITS, LOSS OF THE SOFTWARE PRODUCT OR ANY ASSOCIATED EQUIPMENT, COST OF CAPITAL, COST OF SUBSTITUTE OR REPLACEMENT EQUIPMENT, FACILITIES OR SERVICES, DOWN TIME, PURCHASERS TIME, THE CLAIMS OF THIRD PARTIES, INCLUDING CUSTOMERS, AND INJURY TO PROPERTY.

WARNING: DSC recommends that the entire system be completely tested on a regular basis. However, despite frequent testing, and due to, but not limited to, criminal tampering or electrical disruption, it is possible for this SOFTWARE PRODUCT to fail to perform as expected.

Table of Contents

Safety Instructions for Service Personnel	i
1 Introduction	1
1.1 Compatibility Requirements	1
1.2 Product Specifications	1
1.3 Out of the Box	2
2 Installation	3
2.1 Installation Steps	3
2.2 Terminal Descriptions	3
2.3 Wiring Routing for Power and Non-Power Limited	4
2.4 Keybus Operation and Wiring	4
2.5 Current Ratings – Modules & Accessories	5
2.6 Keypad Assignment	5
2.7 Supervision	5
2.8 Removing Modules	5
2.9 Zone Wiring	5
2.10 Zone Doubling	6
2.11 Fire Zone Wiring	7
2.12 CO Detector Wiring	7
2.13 Keypad Zones	7
3 Keypad Commands	8
3.1 Arming and Disarming	8
3.2 Auto Bypass	8
3.3 Automatic Arming	8
3.4 Night Arming	8
3.5 * Commands	8
4 Programming	13
4.1 Installer Programming	13
4.2 Programming Decimal Data	13
4.3 Programming Hex Data	13
4.4 Programming Toggle Option Selections	14
4.5 Viewing Programming	14
4.6 DLS Programming	14
5 Programming Worksheets	15
5.1 Index to Programming Worksheets and Descriptions	15
5.2 Programming Worksheets	16
5.3 Programming Descriptions	34
6 Testing and Troubleshooting	59
Appendix A: Reporting Code Formats	62
Appendix B: Communicator Format Options	65
Appendix C: Regulatory Approvals Information	67

PC1404 Wiring Diagram

WARNING
High voltage.
Disconnect AC power and telephone lines prior to servicing.

WARNING: All circuits are classified for installation as power limited/Class II power limited, except for the battery leads, which are not power limited. See *Installation Manual* Section 2 Installation. A minimum 1/4" (7mm) separation must be maintained at all points between power-limited wiring and all other non-power-limited wiring.

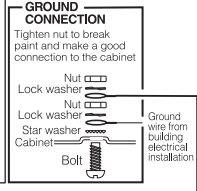

For NA installations only

Use a Class 2 Transformer 16.5VAC 40 VA DSC PTD 1640U. Do not connect transformer to receptacle controlled by a switch.

Note: It is the installer's responsibility to ensure that the external PRIMARY wires are tied together using a cable tie or equivalent as close as possible to the terminal block.

Recommended Battery: DSC model BD7-12.
All terminals Class 2 power limited, except the battery leads.

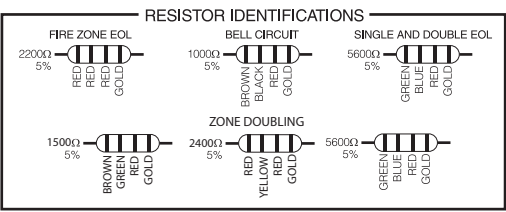
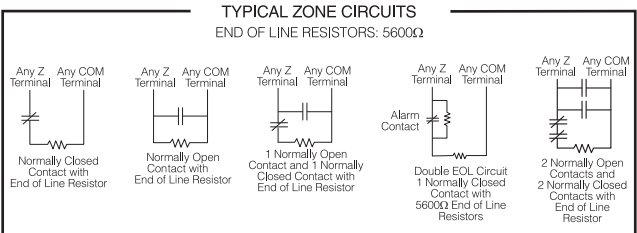
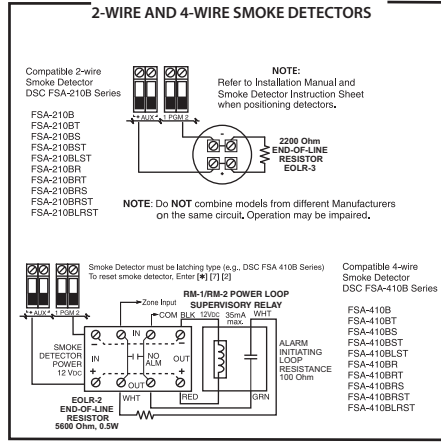
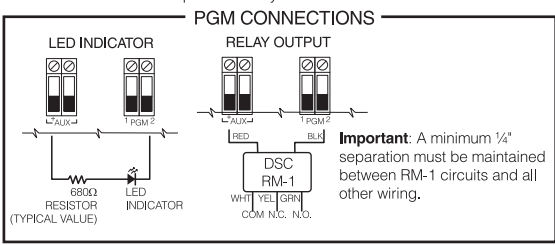
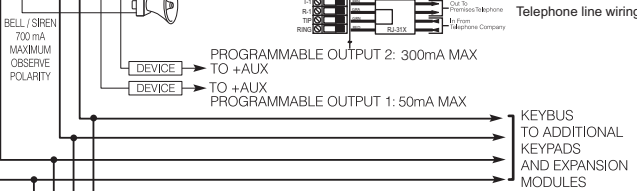
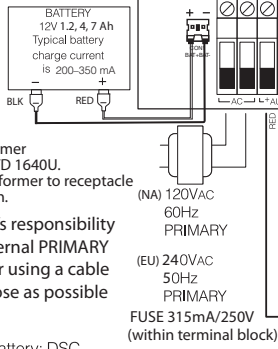

WARNING- Not to be removed by anyone except occupant: This equipment should be installed in accordance with the ANSI/NFPA 72 (National Fire Protection Association, Batterymarch Park, Quincy MA, 02269). Printed information describing proper installation, operation, testing, maintenance, evacuation planning, and repair service is to be provided with this equipment.

Temperature Range: -10°C to +55°C (14°F to 131°F); Maximum Humidity: 93% R.H. Refer to the *Installation and Instruction Manuals* for complete operating instructions. The PC1404 can be used for limited energy installations per NEC Article 760. Recognized limited energy cable should be used. Observe NEC wiring requirements and local codes defined by the authority having jurisdiction. Security detection devices that require power from the control panel must operate over the range of 11.6 -12.6 VDC

This device complies with Parts 15 and 68 of the FCC rules. Operation is subject to the following two conditions: (1) this device may not cause harmful interference, and (2) this device must accept any interference received, including interference that may cause undesired operation.
US: F53AL01BPC1404 REN = 0.1B Plug Type: RJ-11
IC:160A-PC1404
MADE IN CANADA
Digital Security Controls,
Toronto, Canada

WARNING: Incorrect connections may result in PTC failure or improper operation. Inspect wiring and ensure connections are correct before applying power. Incorrect connection of batteries may result in battery rupture or fire hazard. Do NOT allow metal objects to connect the positive and negative terminals. Ensure that batteries are connected with correct polarity (red to (+), black to (-)). Failure to comply with this may result in battery rupture and/or fire hazard.

1 Introduction

This manual provides installation and programming information for the PC1404 four-zone panel security system.

1.1 Compatibility Requirements

The PC1404 product is the central component of the four-zone security system. Interaction with associated system devices is

hardwired, which follows DSC keybus standards. Communications with the central station may be achieved by a hardwired phone line. DLS may also be remotely connected to the panel via phone line or locally connected via the PC-Link header. Shown below are the supported and unsupported modules for the PC1404.

Module	Current Draw, mA	Software Versions
PC1404RKZ/PC1404RKZWH Keypads	145/150	1.0
PK5500/PK5501/PK5508/PK5516 Keypads	125	1.0, 1.1, 1.2, 1.3
LCD5511 Fixed Message LCD Keypad	85	1.0
LED5511Z 8-Zone LED Keypad	100	1.0
PC1555RKZ 8-Zone LED Keypad	85	2.0
PTK5507 Touchscreen keypad	200 (standby) 300 (activated) 400 (Extra Power mode)	1.0
PC5200 Power Supply	20	2.0
PC5204 Power Supply with 4 PGMs	20	2.0
PC5208 Low Current PGM Module	20	1.0
PC5601 LED Status Module	30	1.0
TL300 T-Link TL300 IP Alarm Communicator	360	1.2-1.5
GS3105/3125-K & BA Wireless Alarm Communicator	250 (excluding outputs)	3.0

Module	
PC5100 2-wire interface	PC5964 Large Audio Station
RFK55XX Keypad	PC5401 RS232 Module
RF5132-433 Wireless Receiver	PC5400 Printer + DVACS
RF5108-433 Wireless Receiver	Escort 5580 Telephone Interface
PC5108 Zone Expander	TL260 Series Communicators
PC5320 Zone Expander	GS2060 Series Wireless Alarm Communicator
PC5950 Audio Module	TL250 Communicator
PC5904 Large Audio Station	TL150 Communicator
PC5921 Audio Station	IT100 Integration Module
PC5961, PC5962 Small Audio Station	IT120 Integration Module

4-Wire Smoke Detectors	2-Wire Smoke Detectors
FSA-410x	FSA-210x
FSA-410xT	FSA-210xT
FSA-410xS	FSA-210xS
FSA-410xST	FSA-210xST
FSA-410xLST	FSA-210xLST
FSA-410xR	FSA-210xR
FSA-410xRT	FSA-210xRT
FSA-410xRS	FSA-210xRS
FSA-410xRST	FSA-210xRST
FSA-410xLRST	FSA-210xLRST

Note: For model numbers above, x = A (ULC); x = B (UL); x = C (CE)

1.2 Product Specifications

Control and Indicating Equipment Specifications

Features

- Supports zone doubling — supervised and distinguishable
- NC/Single/Double EOL support
- Supports up to 4 keypads
- 1 Partition support

- 128 events
- Communications: on-board PSTN
- 4 phone numbers
- 2-wire smoke detector support
- 4-wire smoke detector support
- Auto-arming

Zone Configuration

- 31 zone types and 11 programmable zone attributes
- Supports up to 4 hardwired NC, SEOL, DEOL zones, expandable to 8 with the zone doubling feature
- Keypad zones allow the system to be configured to support 8 zones—4 onboard zones and up to 4 keypad zones

Access Codes

- Supports 39 user codes and 1 master code
- 6 programmable user code attributes; see PC1404 User Manual for details
- Duress codes derived from user codes ± 1 digit are not allowed

Programmable Outputs (PGMs)

- Up to an additional 12 PGMs are supported with PGM expander for a total of 14 PGMs on the system
- 24 PGM types
- PGM 1: 50mA switched
- PGM 2: 300mA current-limited switched. This PGM supports compatible 2-wire smoke detectors (90mA current limited)

Power Supply

- 1.5A regulated
- Panel current draw:
 - 240 VAC Primary180 mA(AC)(Max)
 - 120 VAC Primary400 mA(AC)(Max)
 - 16.5 VAC Secondary2A(AC)(Max)
- Nominal panel current draw: 85mA
- 550mA Auxiliary Supply, 12VDC
- Positive Temperature Coefficient (PTC) for BELL, AUX+ and battery terminals
- Reverse Battery Detection/Protection
- Supervision for loss of AC power and low battery
- Output ripple voltage 85mV p-p (Max)

Power Requirements

- Transformer = 16.5VAC, 40VA
- DSC PTD1640U, DSC PTC1640U. Transformers must be Energy Efficient as per the local rules and regulations
- High-efficiency transformer for Australia

Battery

- 12V sealed lead acid battery
- Charging mechanism supports 1.2Ah, 4Ah, 7Ah batteries
- Charging rate: 240mA (12 hrs max.)
- Range for the charge current: 200mA–350mA
- Backup time: 24 hrs
- Replace battery every 3–5 years.
- Low battery trouble indication threshold 11.25VDC
- Low battery trouble restore threshold 11.75VDC
- Battery deep discharge protection: fixed at 9.6V

Aux+:

- Voltage: 9.6–13.8VDC
- Current: 550mA

Note: Aux and PGM outputs share the 550mA load.

Keybus Terminals

- Clock: yellow
- Data: green

Memory

- 32Kbit serial CMOS EEPROM with write protection
- Retains programming and system status on AC or battery failure
- Data retention: 20 years min.

Bell Output

- 12V, 700mA supervised (1k Ω) bell output (current limited at 2A)
- Steady, pulsed, or temporal three Fire, CO alarm cadences
- Bell short detection

Operating Environmental Conditions

- Temperature range: -10°C to +55°C (14°F-131°F)
- Relative humidity: 93% noncondensing

Telco Terminals

Ring	R-1
Tip	T-1

- Ring detection: 30V RMS min
- Protection for high ring voltage - Sidactor

PCB Dimensions

- Length: 153 mm (6.0")
- Width: 94 mm (3.7")
- Height (tallest component): 28 mm (1.1")

System Supervision Features

The PC1404 continuously monitors a number of possible trouble conditions and provides audible and visual indication at the keypad. Trouble conditions include:

- AC Power Failure
- Fire Trouble
- Telephone Line Trouble
- Low Battery Condition
- Bell Circuit Trouble
- General System Trouble (indicates peripheral module trouble)
- General System Tamper (indicates peripheral module tamper)
- Loss of System Time
- Tamper by Zone
- Failure to Communicate

False Alarm Prevention Features

- Audible Exit Delay
- Audible Exit Fault
- Communication Delay
- Entry Delay Urgency
- Quick Exit
- Cross Zone Burglary Alarm
- Rotating Keypress Buffer

Cabinets

Several different cabinets are available for the PC1404. They are as follows:

PC5003C Cabinet

Cabinet for the PC1404 alarm controller. Dimensions (approximate): 288mm x 298mm x 78mm /11.3" x 11.7" x 3"

PC500C Cabinet Household Fire and Burglary

Cabinet for the PC1404 alarm controller. Dimensions (approximate): 213mm x 235mm x 78mm/8.4" x 9.25" x 3.0"

1.3 Out of the Box

Please verify that the following components are included in your system:

- one PC5003C cabinet
- one PC1404 main control circuit board
- one Installation Manual with programming worksheets
- one PC1404 Quick Reference Guide
- one hardware pack consisting of:
 - one 2-wire battery harness; L=34cm black & red
 - two kep nuts 6-32
 - one screw 6-32 x 1/2" Pan Phillips m/s zinc
 - 0.35m wire ground TR64 22GU green
 - one terminal ring 22/18 #6 Stud
 - 1 washer tooth-lock 672-030ZP
 - four 3/8" nylon standoff; locking PCB support
 - eight 5600 Ω (5.6K) 1/2W 5%TR resistors
 - eight 1500 Ω (1.5K) 1/2W 5%TR resistors
 - four 2400 Ω (2.4K) 1/2W 5%TR resistors
 - one 2200 Ω (2.2K) 1/2W 5%TR resistor
 - one 1000 Ω (1K) 1/2W 5%TR resistor

2 Installation

The following sections provide a thorough description of how to wire and configure devices and zones.

2.1 Installation Steps

Read this section completely before you begin. Once you have an overall understanding of the installation process, carefully work through each step.

Step 1: Creating a Layout

Draw a rough sketch of the building to get an idea of where all alarm detection devices, keypads and other modules are to be located.

Step 2: Mounting the Panel

Begin the installation by mounting additional modules in the cabinet using the stand-offs provided. Then, mount the cabinet in a dry, protected area close to an unswitched AC power source and the incoming telephone line. Before attaching the cabinet to the wall, be sure to press the four circuit board mounting studs into the cabinet from the back. After you have attached the cabinet to the wall, stick the provided DSC logo sticker on the front of the cabinet.

Note: You must complete all wiring before connecting the battery, telephone wires and/or applying AC to the panel. Before these operations are performed, the cabinet shall be properly secured to the building structure.

Note: The metallic cabinet door shall be locked using a key (lock) and minimum 2 (two) screws.

Step 3: Wiring the Keybus (Section 2.4)

Wire the Keybus to each of the modules following the guidelines provided in Section 2.4 Keybus Operation and Wiring.

Step 4: Zone Wiring (Section 2.8)

You must power down the control panel to complete all zone wiring. Please refer to Section 2.9 Zone Wiring when connecting zones using normally closed loops, single EOL resistors, double EOL resistors, Fire zones and Keyswitch Arming zones.

Step 5: Complete Wiring (Section 2.2)

Complete all other wiring including bells or sirens, telephone line connections, and ground connections following the guidelines provided in Section 2.2 Terminal Descriptions.

Step 6: Powering up the Control Panel

Once all zone and Keybus wiring is complete, power up the control panel. First, connect the red battery lead to the positive terminal and the black lead to negative. Then, connect the AC.

Note: Connect the battery before connecting the AC. You must apply AC power to the panel for at least 10 seconds, or the panel will not function. The panel will not power up on the battery connection alone.

Step 7: Keypad Assignment (Section 2.6)

In order for keypads to be properly supervised, each must be assigned to a different slot. Please follow the guidelines provided in Section 2.5 Current Ratings – Modules & Accessories when assigning keypads.

Step 8: Supervision (Section 2.7)

The supervision of each module by the panel is automatically enabled upon power up. Please verify that all modules appear on the system according to the instructions in Section 2.6 Keypad Assignment.

Step 9: Programming the System (Sections 4 & 5)

Section 4 Programming explains how to program the panel. Fill out the Programming Worksheets completely before attempting to program the system. (See Section 5 Programming Worksheets).

Step 10: Testing the System

Test the panel thoroughly to ensure that all features and functions are operating as programmed.

2.2 Terminal Descriptions

Battery Connection

A 12V 1.2Ah, 4 Ah or 7Ah rechargeable battery is used as a backup source of power in the event of an AC power failure.

Note: Connect the battery before connecting the AC.

Connect the RED battery lead to the positive battery terminal; connect the BLACK lead to negative.

AC Terminals

The panel requires a 16.5V_{AC}, 40VA transformer. Connect the transformer to an unswitched AC source and connect the transformer to these terminals.

Note: Do not connect the transformer until all other wiring is complete. The transformer secondary wire distance is as shown below:

AWG	Feet	Metres
24	5.8	1.8
22	9.3	2.8
20	14.8	4.5
18	23.5	7.2

Note: For UL Listed installations, do NOT connect transformer to a receptacle controlled by a switch.

AUX+ and AUX- Auxiliary Power Terminals

These terminals provide up to 550 mA of additional current at 9.6–13.8 V_{DC} for devices requiring power. Connect the positive side of any device requiring power to the AUX+ terminal, the negative side to AUX- (ground). The AUX output is protected. This means that if too much current is drawn from these terminals (such as a wiring short), the panel will temporarily shut off the output until the problem is corrected.

Bell Output Terminals – BELL+ and BELL-

These terminals provide up to 700 mA of continuous current at 12 V_{DC} for powering bells, sirens, strobes or other warning-type equipment. Connect the positive side of any alarm warning device to BELL+, the negative side to BELL-. Please note that the Bell output is protected: if too much current is drawn from these terminals (such as a wiring short), the panel will shut down the output. Two amps can be drawn for short periods only.

The Bell output is supervised. If an alarm warning device is connected to the bell terminals, a termination resistor is not necessary. If no alarm warning devices are in use, connect a 1000Ω resistor across BELL+ and BELL- to prevent a Bell Circuit Trouble from being generated. For more information, please refer to [*][2] Trouble Display).



Keybus Terminals – AUX+, AUX-, YEL, GRN

The Keybus is used by the panel to communicate with modules and vice versa. Each module has four Keybus terminals that must be connected to the four Keybus terminals on the panel. For more information, see Section 2.4 Keybus Operation and Wiring.

Programmable Output Terminals – PGM 1 and PGM 2

Each PGM output is designed so that when activated by the panel, the terminal will switch to ground.

PGM 1 can provide up to 50mA. Connect the positive side of the LED or buzzer to AUX+, the negative side to PGM 1. PGM 2 can provide up to 300mA current-limited switched programmable output. If more than 50 mA of current are required, a relay must be used. Please study PGM wiring in the accompanying diagram. Two-wire smoke detectors (90mA current limited) are supported using PGM 2.

For a list, please see the section on Programmable Output Options.

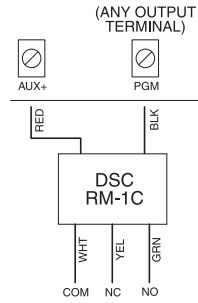

Zone Input Terminals – Z1 to Z4

Each detection device must be connected to a zone on the control panel. It is suggested that one detection device be connected to each zone; wiring multiple detection devices to a single zone, however, is possible. For zone wiring specifics, please see Section 2.9 Zone Wiring.

Telephone Line Wiring

Wire the telephone connection terminals (TIP, Ring, T-1, R-1) to an RJ-31x Connector as indicated. For connection of multiple devices to the telephone line, wire in the sequence indicated. Use 26 AWG wire minimum for wiring.

Telephone format is programmed in option [350].

Telephone Call Directions are programmed in options [351]-[376].

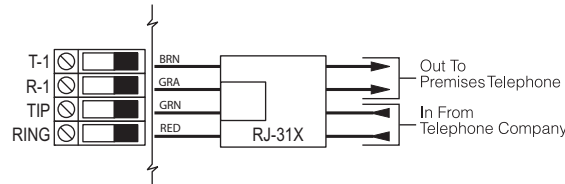

Please ensure that all plugs and jacks meet the dimension, tolerance and metallic plating requirements of 47 C.F.R. Part 68, SubPart F. For proper operation, no other telephone equipment should be connected between the control panel and the telephone company facilities. Do not connect the alarm panel communicator to telephone lines intended for use with a fax machine. These lines may incorporate a voice filter which disconnects the line if anything other than fax signals are detected, resulting in incomplete transmissions.

2.3 Wire Routing for Power & Non-Power Limited

All wiring entry points are designated by the arrows. All circuits are classified power limited except for the battery leads which are not power limited. A minimum 1/4" (7mm) separation must

be maintained at all points between power limited and non-power limited wiring and connections.

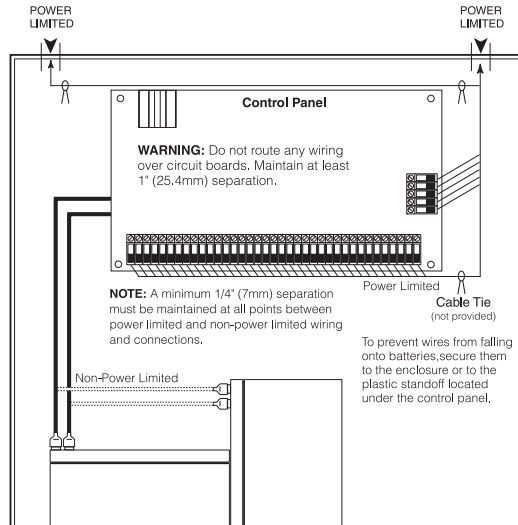

Note: Wire entry for power limited wiring must be separated by using a different entry access from non-power limited wiring.

2.4 Keybus Operation and Wiring

The Keybus is used by the panel to communicate with all connected modules and vice versa. The red (AUX+) and black (AUX-) terminals are used to provide power, while the yellow (YEL) and green (GRN) terminals are clock and data respectively.

Note: The four Keybus terminals of the panel must be connected to the four Keybus terminals or wires of all modules.

The following restrictions apply to Keybus wiring:

- Keybus should be run in minimum 22 AWG quad (0.5mm), maximum 18 AWG; two pair twist is preferred.
- The modules can be home-run to the panel, connected in series or T-tapped, provided that the maximum wire distance from the control panel to any module does not exceed 1,000' (305m).
- Any module can be connected anywhere along the Keybus. You do not need to run a separate Keybus wire for keypads, etc.

Note: Depending on a module's current draw, there may be additional limitations of the wire run length of power and ground.

- Shielded wire should not be used.

Example of Keybus Wiring

Note: Module (A) is correctly wired within 1,000'/305m of wire from the panel.

Module (B) is correctly wired within 1,000'/305m of wire from the panel. Module (C) is NOT wired correctly as it is further than 1,000'/305m from the panel, in wire distance.

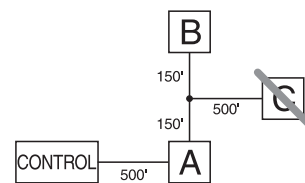

2.5 Current Ratings – Modules & Accessories

In order for the PC1404 system to operate properly, the power output capabilities of the main control and the expansion devices must not be exceeded. Use the data presented below to ensure that no part of the system is overloaded, affecting its function.

PC1404 (12 Vdc)

AUX+: 550mA: Subtract the listed rating for each keypad, expansion module and accessory connected to AUX+ or Keybus.

BELL: 700mA Supervised (1k Ohm) Bell Output (Current Limited at 2A).

PC1404 Device Ratings (at 12 Vdc)

- PC1404RKZ/PC1404RKZWH keypads: 145mA/150mA
- PK55XX keypad: 125mA
- PC1555RKZ keypad: 85mA
- PTK5507 Touchscreen keypad: 200 mA(standby)/300 mA(activated)/400 mA(Extra Power mode)
- PC5601 LED status module: 30mA
- LCD5511 keypad: 85mA
- LED5511Z keypad: 100mA
- PC5200 power supply: 20 mA
- PC5204 power supply with 4 PGMs: 20 mA
- PC5208 low current PGM module: 20 mA
- TL300 communicator: 360mA
- GS3125 communicator: 250mA

Other Devices

Please read the manufacturer's literature carefully to determine the maximum current requirements for each device—during activation or alarm—and include the proper values for loading calculations. Connected devices must not exceed system capabilities during any possible operational mode.

2.6 Keypad Assignment

Once the wiring is complete and the keypad is fixed on the wall, a 2-digit number must be entered to tell the system the partition and slot assignment of the keypad. At each keypad installed on the system

1. Enter Installer Programming by pressing [*][8][Installer Code].
2. Press [000] for keypad programming.
3. Press [0] for Partition and Slot Assignment.
4. Enter a 2-digit number to specify the partition and slot assignment as follows:
 - a) As the PC1404 does not have partitions, enter [1] for the first digit. If the first digit is incorrectly programmed with a value greater than 1, the keypad will not respond when connected to a single partition system (e.g. PC1404). Press and hold the 1 key on the keypad, then re-enter section [000][0] to correct the programming.
 - b) Assign each keypad to its own slot (1 to 8). LED keypads, the LCD5511 and the PC1404RKZ/PC1404RKZWH keypads are always assigned to slot 1 by default. PK5500 and PTK5507 keypads are always assigned to slot 8. Keypad assignment is required, as it tells the panel which slots are occupied. The panel can then generate a keypad supervision trouble when the keypad is detected as missing.

Note: One LCD keypad must be assigned to slot 8 in order to upload keypad programming using DLS software.
 - c) Press the [#] key twice to exit programming.
 - d) After assigning all keypads, perform a supervisory reset by entering [*][8][Installer Code][902]. The panel will reset supervision and re-enroll modules on the system.

How to Program Function Keys

By default, the 5 function keys on each keypad are programmed as Stay Arm (03), Away Arm (04), Chime (06), Sensor Reset

(14) and Quick Exit (16). You can change the function of each key on every keypad:

1. Go to the keypad where you want to change the function key programming and enter Installer Programming.
2. Press [000] for Keypad Programming.
3. Enter [1] to [5] to select a function key to program.
4. Enter the 2-digit number [00] to [32] to select the feature you want the function key to have. For a complete list see Section [000] Keypad Function Programming.
5. Continue from step 3 until all function keys are programmed.
6. To exit Installer Programming, press [#] twice.

2.7 Supervision

By default, all modules are supervised upon installation. Supervision is enabled at all times so that the panel can indicate a trouble if a module is removed from the system.

To check which modules are currently connected and supervised, enter programming Section [903] from Installer Programming. An LCD keypad will allow you to scroll through the display of connected modules. A connected module which does not show as being present will appear as a trouble condition and the Trouble light on the keypad will turn ON. This condition may be due to one or more of the following reasons:

- the module is not connected to the Keybus
- there is a Keybus wiring problem
- the module is more than 1,000/305m from the panel
- the module does not have enough power

For more information regarding module supervision troubles, please refer to [*][2]Trouble Display.

2.8 Removing Modules

The panel must be instructed to no longer supervise a module being removed from the system. To remove the module, disconnect it from the Keybus and reset the supervision field by entering [902] in Installer Programming. The panel will reset supervision of all existing modules attached to the keybus.

2.9 Zone Wiring

For a complete description of the operation of all zone types, please refer to [001] Zone Definitions.

There are several different ways in which zones may be wired, depending on which programming options have been selected. The panel can be programmed to supervise normally closed, End of Line, Double End of Line, or zone doubling loops. Please refer to the following diagrams to study each type of individually supervised zone wiring.

Note: Any zone programmed for Fire, 24-hr Supervisory, or CO must be wired with a single End of Line (SEOL) resistor regardless of the type of zone wiring supervision selected for the panel ([013] First System Options: [1]-[2]).

Note: If you change the zone supervision options from DEOL to SEOL or from NC to DEOL (See [013] First System Options, Options [1] or [2]), you should power down the system completely, and then power it back up. If you do not, the zones may not work correctly.

Normally Closed (NC) Loops

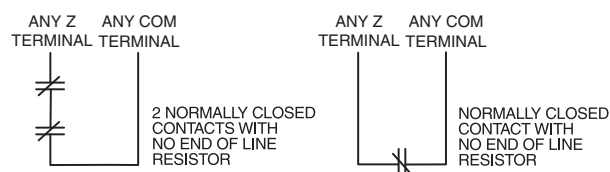

To enable normally closed loops, Section [013], Option [1] must be ON.

Note: This option should only be selected if Normally Closed (NC) detection devices or contacts are being used.

Single End Of Line (EOL) Resistors (5600Ω)

To enable panel detection of single end of line resistors, Section [013], Options [1] and [2] must be OFF.

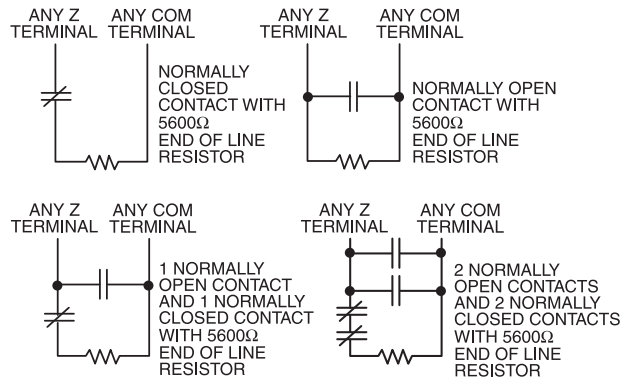

Note: This option should be selected if either Normally Closed (NC) or Normally Open (NO) detection devices or contacts are being used.

Double End of Line (DEOL) Resistors

Double End of Line resistors allow the panel to determine if the zone is in alarm, tampered or faulted.

To enable panel detection of double end of line resistors, Section [013], Option [1] must be OFF and Option [2] must be ON.

Note: If the Double EOL supervision option is enabled, all hard-wire zones on the main panel must be wired for Double EOL resistors, except for Fire, CO and 24-hr Supervisory zones.

Note: Do not use DEOL resistors for Fire zones, CO zones or 24-hr Supervisory zones. Do not wire Fire zones to keypad zone terminals if the DEOL supervision option is selected.

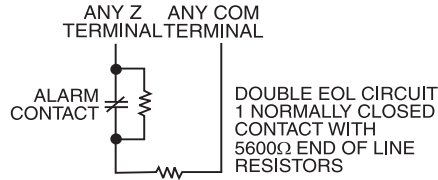

Note: This option can only be selected if Normally Closed (NC) detection devices or contacts are being used.

The following chart shows zone status under certain conditions:

Loop Resistance	Loop Status
0Ω (shorted wire, loop shorted)	Fault
5600Ω (contact closed)	Secure
Infinite (broken wire, loop open)	Tamper
11200Ω (contact open)	Violated

End of Line Resistors Section [013]: [1]
 Double End of Line Resistors Section [013]: [2]

2.10 Zone Doubling

Zone Doubling is a feature that will allow you to double the zones on the main board from 4 to 8. To enable zone doubling, Section 13 Option [7] must be ON. All zones must be wired according to the following diagram. Only Normally Closed devices can be used with zone doubling.

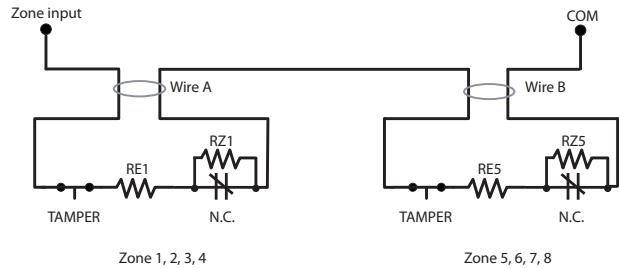

RE1	RZ1	RE5	RZ5
1500	5600	1500	2400

Note: All resistors are 5% tolerance.

The loop using the 1500Ω and 5600Ω resistors is the first zone (Zone 1, 2, 3, or 4). The loop using the 1500Ω and 2400Ω resistors is the second zone (Zone 5, 6, 7, or 8). For example, loop 1 is Zone 1 and loop 2 is Zone 5. The following table shows zone status under certain conditions:

Nominal	Tamper	Zone 1	Zone 5	Fault
∞	✓	-	-	-
11000	-	open	open	-
8600	-	open	restore	-
7100	-	-	-	✓
5400	-	restore	open	-
3900	-	-	-	✓
3000	-	restore	restore	-
1500	-	-	-	✓

Note for tech support: The following will be seen by the installer if the end-of-line resistors have not been installed correctly, when both zones are physically closed:

Zone 1 open, Zone 5 restored	This may be caused by RE1 and RZ1 as well as RE5 and RZ5 being switched.
Both zones showing as faulted.	This may be caused by RE1 and RZ1, or RE5 and RZ5, being switched.

Note: If zone doubling is enabled, fire zones should not be programmed. 2-wire smoke loops can still be used.

Note: If zone doubling is enabled, keypad zones should not be programmed.

Note: If fire zone types are programmed in Section [001], or if a keypad zone has been assigned, it will not be possible to enable the zone doubling option in Section [013].

2.11 Fire Zone Wiring

All 4-wire smoke detectors must be wired according to the following diagram:

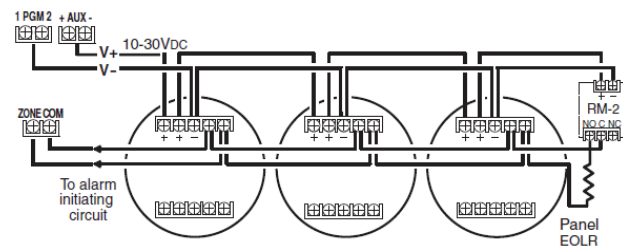

All 2-wire smoke detectors must be wired according to the following diagram:

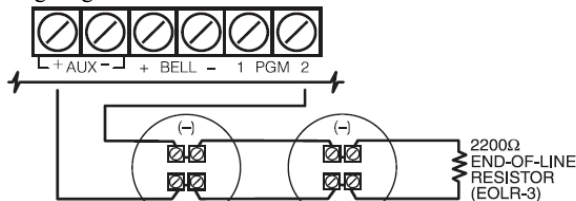

Additional 2-wire smoke detectors must be connected in parallel as shown above.

2.12 CO Detector Wiring

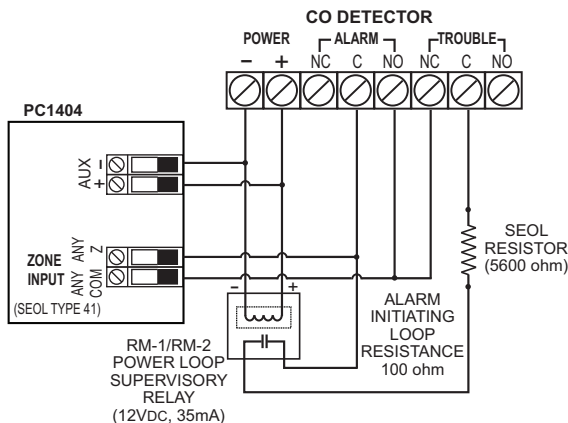

The following CO detector models can be used with PC1404 v1.0 and higher control panels:

- Potter Model CO-12/24, UL File E321434
- Quantum Model 12-24SIR, UL File E186246
- NAPCO Model FW-CO12 or FW-CO1224, UL File E306780
- System Sensor Model CO1224, UL File E307195

2.13 Keypad Zones

Each “z” keypad on the system has a zone input to which a device - such as a door contact - can be connected. This eliminates the need to run wires back to the control panel for every device.

To install the keypad, open the keypad plastic at the bottom of the unit. Locate the five terminals on the keypad circuit board. Connect the four Keybus wires from the control panel: the red wire to R, the black to B, the yellow to Y and the green to G.

To connect the zone, run one wire to the Z terminal and the other to B. For powered devices, use red and black to supply power to the device. Run the red wire to the R (positive) terminal and the black wire to the B (negative) terminal.

When using end of line supervision, connect the zone according to one of the configurations outlined in Section 2.9 Zone Wiring. End of line resistors must be placed on the device end of the loop, not at the keypad.

Keypad circuit board



Keypads without zone support do not have this "Z" terminal

Note: Only non 24-hr burglary zones can be configured as keypad zones for UL Listed products.

Assigning Keypad Zones

When using keypad zone inputs, each input used must be assigned a zone number in Installer Programming.

1. Ensure that you have enrolled all installed keypads into the desired slots. (See Section 2.6 Keypad Assignment.)
2. Enter [*][8] [Installer Code] to go to Installer Programming.
3. Enter Section [20] for Keypad Programming. There are eight programming locations in this section, one for each keypad slot.
4. Enter a 2-digit number (01-08) to specify which zone number should be assigned to the keypad slot. This number must be entered in the location corresponding to the keypad to which each zone is connected.

Example: The zone on an PK5500 keypad in Slot 8 is to be assigned Zone 3. In Section [020], scroll to Option [8] and enter (03).

Note: Keypad Zones 1-4 will replace Zone terminals Z1-Z4 on the control panel.

Note: Once the keypad zones are assigned, you must also program zone definitions and zone attributes. (See also 5.2 Programming Worksheets).

Note: Keypad zones can only be used for household burglary-initiated devices. Do not place the device more than 3 feet from the keypad. The keypad zone must be tested weekly.

3 Keypad Commands

Use any compatible keypad to enter commands and/or program the PC1404 security system. The LED keypad uses function and zone indicator lights to represent alarm functions and status. The LCD keypad provides a written description on the liquid crystal display and uses function indicator lights to communicate alarm status to the user.

The PC1404 User Manual provides basic directions for arming and disarming the system, bypassing zones and performing user functions from the keypads. The following sections provide additional details on these functions.

3.1 Arming and Disarming

For a description of basic arming and disarming, please see the PC1404 User Manual. For other methods of arming, please refer to [*][0] – Quick Arm, [*][9][User Code] – No-Entry Arming and [000] Keypad Function Programming.

The event buffer will log “armed in stay mode,” “armed in away mode,” or “armed in night mode” whenever the system is armed.

In an attempt to prevent false alarms, the **Audible Exit Fault** will notify the user of an improper exit when they arm their system. If a non force-arming Delay 1 or Delay 2 type zone is left open at the end of the exit delay, the entry delay will begin immediately and the bell or siren will sound a steady alarm for the entry delay period. At the end of the entry delay period, if the system has not been disarmed it will go into alarm. This feature can be turned OFF in Section [013], Option [6].

3.2 Auto Bypass – Stay Arming

Stay arming allows the user to arm the system without leaving the premises. All zones programmed as stay/away will be bypassed when the user stay arms the system, so that the user does not have to bypass interior zones manually. (See “Zone Programming”.)

When the system is armed using a valid access code, if any zones on the system have been programmed as stay/away zones, the Bypass light will turn ON. The panel will then monitor all zones programmed as Delay 1 and Delay 2 zones, such as designated entry/exit doors. If a delay zone is not violated by the end of the exit delay, the panel will bypass all stay/away zones. The Bypass light will remain on to inform the user that the interior zones have been automatically bypassed by the panel. If a delay zone is violated during the exit delay, the system will arm in Away mode and all stay/away zones will be active after the exit delay expires.

The user can arm the stay/away zones at any time by entering the [*][1] keypad command. (See “[*][1] Bypassing and Activating Stay/Away and Night Zones”.)

Stay arming can also be initiated by pressing and holding the Stay function key for two seconds on the supported keypads, if programmed by the installer. For more information regarding Stay arming, please see [000] Keypad Function Programming.

3.3 Automatic Arming

The system can be programmed to arm at the same time each day. Upon entry of this section, enter 4 digits for the 24 Hour Auto-Arm time. At the selected Auto-Arm time, the keypad buzzers will sound for the time programmed in Section [199] to warn that an Auto-Arm is in progress. The bell can also be programmed to squawk once every 10 seconds during this warning period. When the warning period is complete, the system will arm with no exit delay and in the Away Mode.

Auto-Arming can be cancelled or postponed only by entering a valid access code during the programmed warning period. When the code has been entered, the warning will be silenced and Auto-Arming will be canceled or postponed, depending on the programming of Section [175]. Auto-Arming will be attempted at the same time the next day. Whenever the Auto-Arming process is canceled or postponed, the Auto-Arm Cancellation Reporting Code will be transmitted (if programmed).

If arming is inhibited by one of the following, the Auto-Arm Cancellation transmission will be communicated.

- AC / DC Inhibit Arm
- Latching System Tamper
- Zone Expander Supervisory Fault

Note: PC1404 only supports one entry of Auto-Arm Time programming, so the programmed time shall be used for every day.

3.4 Night Arming

Night arming is intended to arm the perimeter and restrict movement to designated areas in the interior (e.g., hallways from bedrooms to bathrooms).

If night zones are programmed, entering [*][1] while the system is armed in stay mode will activate all interior zones except those programmed as night zones. The panel can also be armed in Night mode by pressing the Night Arm function key for 2 seconds while the system is disarmed. The Ready light must be on (disarmed) or the system must be armed in Stay mode to Night arm the system. In Night mode only night zones (Zone definition 37) are bypassed. When activated, no acknowledgement beeps are sounded, the exit delay is silent and the panel logs “Armed in Night Mode.” If no night zone types are programmed, the system arms in Away mode and the panel logs “Armed in Away Mode.”

3.5 [*] Commands

The [*] key commands provide an easy way for the user to access basic system programming – such as programming access codes or bypassing zones. The user can also use the [*] key commands to check on the system’s status, including viewing trouble conditions and displaying the event buffer on the LCD keypad.

The [*] key commands can be performed from both LCD and LED keypads. The LED keypad uses the zone indicator lights to display command information. The LCD display provides written information, guiding the user through each command. The commands in this section are explained as viewed from an LED keypad. When using an LCD keypad, use the arrow keys (< >) to scroll through information provided. Otherwise, the functions remain the same for both keypad types.

[*] Commands

The following is a list of the [*] commands available and a description of each:

[*][1]	Bypass (disarmed state)/Reactivate Stay/Away and Night Zones (armed state)
[*][2]	Display Trouble Conditions
[*][3]	Display Alarm Memory
[*][4]	Door Chime Enable/Disable
[*][5][Master/Supervisory Code]	User Code Programming
[*][6][Master/Supervisory Code]	User Functions

[*][7][x]	Command Functions 1–4
[*][8][Installer Code]	Installer Programming
[*][9][User Code]	No-Entry Arming
[*][0]	Quick Arm (disarmed state)/Quick Exit (armed state)

[*][1] Bypassing and Activating Stay/Away and Night Zones

LED Keypad

Press [*][1] to enter the bypass mode. If the Code Required for the Bypass option is enabled, enter a valid user code. The Bypass light will flash. The keypad will turn ON the corresponding zone light to indicate a zone is bypassed. To bypass or unbypass a zone, enter the 2-digit zone number. Once the correct zones are bypassed, press [#] to exit. The Bypass light will be ON if any zones are manually bypassed.

LCD Keypad

Press [*][1] to enter the bypass mode. If the Code Required for the Bypass option is enabled, enter a valid user code. The keypad will display 'Scroll to View Zones'. The keypad will display the programmed zone labels for the zones and include the letter 'O' in the bottom right corner if the zone is violated, or the letter 'B' if the zone is bypassed. Scroll to the appropriate zone and press the [*] key to change the bypass status (or enter the 2-digit zone number). Once the correct zones are bypassed, press [#] to exit.

Additional Bypass Commands:

Bypass Recall: Press [99]. The keypad will recall the last group of zones that were bypassed.

Clear Bypass: Press [00]. The keypad will clear the bypass on all zones.

Save Bypass: Press [95]. The keypad will save which zones are manually bypassed.

Recall Save: Press [91]. The keypad will recall the bypassed zones that were saved.

i	Hold-up Zones cannot be assigned to bypass groups.
----------	---

[*][1] Activate Auto-Bypassed Stay/Away and Night Zones

When the system is armed in the Stay mode by (a) arming and not exiting through a delay zone during the exit delay; or (b) pressing a function key programmed for Stay Arm or Arming Without Entry Delay [*][9], the zones programmed as "Stay/Away" or "Night" type zones are automatically bypassed. This [*][1] command is used to remove the automatic bypass from the Stay/Away zones to fully arm the system zones to fully or "Night" arm the system. Once this command is executed, all Stay/Away type zones will become active after the programmed Exit Delay time, making the system armed in Night or Away mode. When the system is armed in the Away or Night mode, if enabled by the installer, this [*][1] command will bypass all of the "Stay/Away" type zones immediately, making the system armed in Stay mode. Night or Away mode is determined by whether there is a Night zone programmed on the system.

Note: Although there is an exit delay timer running, it is only an arming delay for the Stay/Away zones, and not a true exit delay where all non-24 hour zone types can be opened and closed for the purpose of exiting. Any zone type that is not a Stay/Away zone type will start its alarm sequence if violated during this "exit delay". Users should press *0 next to start a Quick Exit Delay to exit the premises.

[*][2] Trouble Display

The panel continuously monitors a number of possible trouble conditions. If one of these conditions occurs, the keypad "Trouble" indicator will light and the audible indication will sound, two short beeps every 10 seconds (except AC failure). When the [#] key is pressed the audible indication will stop but the trouble is not cleared. Trouble conditions are logged to the Event Buffer and most troubles can also be transmitted to the monitoring station.

To view troubles, press [*] then [2]. The "Zone" lights or LCD text display the trouble conditions 1-8.

Troubles 1, 5, and 6 can be expanded for more details by pressing the corresponding [1], [5], or [6] key.

Press [#] to return to the "Ready" mode. There is no Trouble memory. The Event Buffer can be used to achieve this function.

Viewing of troubles is now permitted while armed. The various troubles are described below:

Light	Trouble
1	<p>Service Required: Press [1] to determine the specific trouble. Lights 1–8 will light up to indicate the trouble.</p> <p>Light [1] Low Battery: The standby battery's voltage is measured under load every 3 minutes and during a System Test. The limits of alarms and restores are determined by the Swinger Shutdown (Maintenance Troubles & Restores) counter. Set at 3 by default, there will be 3 Low Battery Troubles and 3 Low Battery Restores before latching. The latching is reset at midnight or upon arming.</p> <p>Light [2] Bell Circuit Trouble: If the bell circuit is overdrawn or the bell circuit is open, a keypad trouble is generated and a Bell Circuit Trouble can be reported.</p> <p>Light [3] General System Trouble: Any peripheral module trouble will be indicated and communicated with a General Trouble, but logged to the event buffer with a detailed description.</p> <p>Light [4] General System Tamper: Any peripheral module tamper will be indicated and communicated with a General Tamper but logged to the event buffer with a detailed description.</p> <p>Light [5] General System Supervisory: If the system loses Supervisory signals from a peripheral module, this will be indicated and communicated with a General Supervisory but logged to the event buffer with a detailed description.</p> <p>Light [6] Not used.</p> <p>Light [7] PC5204 Low Battery: The PC5204 Module has detected a Low Battery Condition.</p> <p>Light [8] PC5204 AC Fail: The PC5204 Module has detected an AC Power Failure. This Trouble will initiate the keypad trouble beeps after the AC fail transmission delay if Trouble #2 is NOT present.</p>

Light	Trouble
2	AC Failure: There is no audible annunciation on AC power failure unless trouble beeps on AC failure are enabled in Section [018] Option [8]. The system "Trouble" light will come ON but the audible indication will not sound until there is a low battery condition. Transmission delay can be programmed for 000 to 255 minutes/hours. If the AC Fails, the battery will be continuously checked until the panel shuts down.
3	Telephone Line Monitoring Trouble (TLM): The telephone line voltage is measured every 3 seconds. If the voltage drops below 1 to 3 volts for the number of consecutive checks programmed in Section [377], a Telephone Line Trouble is generated. This additional check denomination may fluctuate from board to board, as it is dependant on hardware component tolerances. The TLM Restore shall occur when the value in Section [377] is reached.
4	Failure to Communicate (FTC): If the digital communicator is unsuccessful in communicating with any of the programmed telephone numbers, a failure to communicate trouble will be generated. If a later attempt to communicate is successful, the panel can also transmit the FTC restore reporting code and all previous unsuccessful events. If the digital communicator is unsuccessful in communicating with any of the programmed telephone numbers, a failure to communicate trouble will be generated. If a later attempt to communicate is successful, the panel can also transmit the FTC restore reporting code and all previous unsuccessful events.
5	Zone Fault (including Fire Zone): If any zone on the system is in the Trouble state, this trouble will be generated. For hardwired zones (excluding Fire) using double end of line supervision, this is the shorted state. If DEOL is not used, Zone Troubles can still be generated on Fire Zones (open state). If [5] is pressed in the Trouble mode, the keypad will now display all of the zones in trouble. Fire Zone Faults are identified in the Event Buffer. They log a "Fault Zone X" followed by a generic "Fire Trouble". This has been done so that intermittent wiring problems may be tracked down via the Event Buffer. This trouble will be generated and displayed in the armed state if a Fire trouble is present. It will also restart the Trouble beeps. If any zone enters this Trouble state (short), the keypad buzzers will sound trouble beeps to annunciate the condition.
6	Zone Tamper: This trouble is used with DEOL Zone Supervision only. If any zone is in the Tamper state, this trouble will be generated. Zones excluded from this are Fire and zones not supporting the DEOL configuration (LINKS answer, Key-switch). Press [6] in the Trouble mode to display all of the tampered zones. If any zone enters this Tamper state (open), the keypad buzzers will sound trouble beeps to annunciate the condition.
7	Not Used
8	Loss of System Time: When the panel is powered up, the internal clock needs to be set to the correct time. This trouble is cleared when an attempt is made to reset the clock.

[*][3] Alarm Memory

When Disarmed, press [*] then [3] to enter the alarm memory mode. The "Memory" light will flash and any alarm caused during the last armed period will be displayed on the zone lights.

Press [#] to return to the "Ready" mode. If [#] is not pressed, the keypad will time out in 30 seconds.

There is no memory of previous armed states. The Event Buffer can be used to achieve this function.

[*][4] Door Chime On/Off Command

When Armed/Disarmed, to turn the feature on or off, enter [*][4]. The Door Chime feature is used to sound a tone from the keypad whenever a zone programmed as a Chime type is activated. When the Door Chime feature is turned ON, the keypad will beep several times whenever a Chime zone is activated. When the feature is being turned ON, the keypad will beep 3 times and the LCD will display "Door Chime Feature ON". When the feature is being turned OFF, the keypad will sound a single long tone and the LCD keypad will display "Door Chime Feature OFF".

[*][5] Program User Codes

The following table identifies available user codes:

Code	Type	Function
[01] – [39]	General User Codes	Determined by attributes programmed below
[40]	Master Code	

When Disarmed, enter [*][5] to access the attribute programming mode.

1) The default attributes of a new code will be the attributes of the code used to enter [*][5] whether it is a new code or an existing code being programmed.

2) All user codes will now have a check so that they cannot be + or -1 of any other code.

Inherent Attributes (All codes except Installer and Maintenance)

Arm/Disarm - Any access code is valid for arming and disarming.

Command Outputs [*][7][1] - If the output requires an access code entry, any valid access code can be used.

Programmable Attributes ([*][5][Master/Supervisor Code][99][Code])

[1] Supervisor's Code – This code is used for validation when entering the [*][5] User Code Programming section. However, this code can only program codes which have equal or lesser attributes. These attributes are changeable.

[2] Duress Code – Duress codes are standard user codes that will transmit the Duress Reporting Code whenever the code is entered to perform any function on the system.

Duress codes are not valid when entering [*][5], [*][6] or [*][8] sections.

A code cannot be programmed as a duplicate or as a code + or -1.

[3] Zone Bypassing Enabled – This attribute controls whether the user can bypass zones. This also requires that option Code Required for Bypassing option is turned ON.

[4] Remote Access – This attribute controls access to the system via a telephone during remote access.

[5] For Future Use

[6] For Future Use

[7] Bell Squawk upon Arming/Disarming – This attribute is used to determine whether an access code should generate an arming/disarming bell squawk at the end of exit delay. The attribute is off at default for all access codes, and this feature is meant to be used when Bell Squawk on Arming/Disarming is disabled in Section [014]. However, if the away function key is pressed on the system keypad, followed by an access code with this attribute enabled, the bell will still squawk.

[8] One-Time-Use Code – When the one-time-use code is entered on the system, the user of the code will be able to arm the panel with the code as many times as they want. They will also be able to disarm the system using the code once per day. The disarming operation will be reset at midnight, or if the code or its attributes are viewed in the [*][5] Access Code Programming. A code programmed as one-time use can be used to access other star menus that require an access code.

Notes on Access Codes and Programming

Note: [*][5][MASTER CODE] [01 to 39 40] to program access codes.

[*][5][MASTER CODE][99] enters the Attribute Mode [01 to 39] to edit access code attributes.

Note: The Master Code's attributes cannot be changed.

Note: When a new code is programmed in either [*][5] or through Installer Programming, it will be checked against all other codes in the system. If a duplicate code is found, an error tone is given, and the code is returned to what it was before it was changed. This applies to both 4- and 6-digit codes.

Note: In [*][5] if a duress code is being programmed, it will be checked to make sure that it is not 1 digit more than any other code in the system. This will only apply to the least significant digit and does not roll over to the next digit. If a user code is 1234, then the duress codes 1234 and 1235 are not allowed. If the user code is 1239, then duress cannot be 1239 or 1230, but could be 1240. This applies to both 4- and 6-digit codes.

Note: See also [006] Installer Code and [008] Maintenance Code.

Erasing an Access Code

To erase an access code, the user will have to go into the base menu and then select the user number and enter [*] as the first digit. If [*] is entered, the system will delete the code immediately and the user will be returned to select another code.

[*][6] – User Functions

To access the User Functions section, when disarmed, press [*][6] followed by the master or supervisor code. Select one of the functions described below by pressing the corresponding number or scrolling to the desired option then pressing [*].

- [1] **Program Time and Date:** Enter the time and date using the following format [HH:MM] [MM/DD/YY]. Program the time using military standard (e.g., 8:00 pm = 20:00 hours). Valid entries for the Hour are 00-23. Valid entries for the Minute are 00-59.
- [2] **Auto-Arm Control:** Pressing [2] while in the User Function menu will enable (3 beeps) or disable (one long beep) the Auto-Arm feature. With this feature enabled, the panel will automatically arm in the Away mode (Stay Away zones active) at the same time each day. The Auto-Arm time is programmed with the [*][6][Master Code][3] command.
Note: Keypads are required if Auto-Arm is to be used.
- [3] **Auto-Arm Time:** The system can be programmed to arm at the same time each day. Upon entry of this section, enter 4 digits for the 24 Hour Auto-Arm time. At the selected Auto-Arm time, the Keypad Buzzers will sound for the programmed time in Section [199] to warn that an Auto-Arm is in progress. The bell can also be programmed to squawk once every 10 seconds during this warning period. When the warning period is complete, the system will arm with no exit delay and in the Away Mode. Auto-Arming can be cancelled or postponed only by entering a valid access code during the programmed warning period. When the code has been entered, the warning will be silenced and Auto-Arming will be canceled or postponed, depending on the Programming of Section [175]. Auto-Arming will be attempted at the same time the next day. Whenever the Auto-Arming process is cancelled or postponed, the Auto-Arm Cancellation Reporting Code will be transmitted (if programmed).
The Auto-Arm Cancellation will be transmitted if arming is inhibited by one of the following:
 - AC/DC Inhibit Arm
 - Latching System Tamper
 - Zone Expander Supervisory Fault.
 PC1404 only supports one entry of Auto-Arm Time programming, which means the programmed time shall be used for every day auto arm.
- [4] **System Test:** The system's Bell Output (2 sec), Keypad Lights and Communicator are tested. This test will also measure the panel's standby battery. The system activates the siren output on medium volume for 2 seconds followed by full volume alarm for 2 seconds. All display lights and LCD pixels turn on. When the System Test event is successfully received at the monitoring station, the keypad will sound ringback, a series of 8 beeps.
- [5] **System Serv/DLS:** If enabled, this opens a window where incoming rings on the phone line are detected by the panel. This window remains open for 6 hours. After the window has expired, DLS access will not be permitted.
- [6] **User Call-up:** If enabled by the installer, when this command is executed, the panel will make 1 attempt to call the downloading computer. The downloading computer must be waiting for the panel to call before downloading can be performed.
- [7]-[0] **For Future Use**

Additional Keypad Functions

The following additional keypad functions are available:

Event Buffer:	View the 128-event panel buffer
Brightness Control:	Adjust the display backlighting level for optimal viewing
Contrast Control:	Adjust the display contrast level for optimal viewing
Buzzer Control:	Adjust the keypad buzzer tone for optimal sound

[*][7] – Command Outputs

When armed or disarmed, press [*][7] followed by the command output number 1 to 4. When any command output is activated, three acknowledgement beeps are heard. The system can be configured to require a valid access code to activate a command output.

[*][8] – Installer Programming

When disarmed, press [*][8][Installer Code] to enter Installer Programming. Installer Programming allows the installer to program all system functions. Refer to Section 4.1 Installer Programming for details. The PC1404 v1.00 is completely programmable from any system keypad using this command.

Note: Three-digit entries are required for section entry. When an error is made in attempting to enter a section number, [#] can be pressed. If [#] is the first digit pressed, however, the keypad will return to the base menu.

Note: Once inside Installer Programming, the keypad will remain there for 20 minutes after the last keypress.

Note: All system events that occur while in Installer Programming will be logged to the Event Buffer and printed on the system printer; however, these events will not be transmitted.

Note: When viewing data in sections with an LCD keypad, use the [<] and [>] keys to scroll. If using an LED keypad, press the [F] key to scroll.

[*][9][User Code] – No-Entry Arming

When disarmed, entering [*][9] or pressing a function key programmed for No Entry Arm before entering an access code arms the panel without any entry delay on the perimeter delay zones and bypasses zones that are defined as "Stay Away". This command is used to arm the system while at home. When the system is armed in this mode, the "Armed" light will be ON flashing and the bypass light will be on to indicate the "Stay Away" zones are bypassed. Once the panel is armed in this mode, using [*][1] will remove the bypass from the "Stay Away" zones if they were NOT manually bypassed. The [*][1] command used here only removes the bypass from zones that have been automatically bypassed with the [*][9] command. Delay Stay/Away and Interior Delay Zones will still have Entry Delay on a [*][9] armed panel.

[*][0] – Quick Arm

When disarmed, press [*][0] to activate Quick Arm. Quick Arm may be used as a convenience for regular users or when the system is to be armed by individuals who are not authorized to disarm the system. This panel will log either "Armed in Stay Mode" or "Armed in Away Mode" for this closing type.

[*][0] – Quick Exit

When armed, press [*][0] to activate Quick Exit. Quick Exit allows the user 2 minutes to exit the premises through any delay zone without altering the status of the system if the Quick Exit feature is enabled. After [*][0] is entered, one and only one delay zone may be tripped. If the delay zone is left unrestored at the end of the 2 minutes, it will begin its entry delay sequence. Any additional activity on any other active zone will cause that zone to begin its alarm or delay sequence. Quick Exit is not designed to extend the standard Exit Delay.

4 Programming

The PC1404 can be programmed using the following methods:

Programming Method	Description	Procedure
Installer Programming	Allows direct access to all programming sections.	Press [*][8][Installer's Code] while the system is disarmed. See 4.1 Installer Programming for details.
DLS Programming	Allows programming to be downloaded using DLS-IV™ software. DLS programming can be performed locally with a PC-Link cable and a PC with DLS-IV software installed. DLS programming can be performed remotely via telephone line.	DLS Programming can be set up from Installer Programming (see [401] Downloading Option Codes). Note: Panel communications will interfere with the PC-link connection. Ensure the PC1404 is not communicating before attempting a local DLS connection.

4.1 Installer Programming

The following section of the manual describes the Installer Programming functions and how to program the various sections.

Read the following section of the manual very carefully before you begin programming. We also recommend filling out the Programming Worksheets section before you program the panel.

Installer Programming is used to program all communicator and panel options. The Installer Code is [5555] by default (555555 if 6 digit codes are used) but should be changed to prevent unauthorized access to programming.

From an LED or fixed message LCD keypad:

- Enter [*][8][Installer Code].
The Program light (or System light on the PC1555RKZ) will flash to indicate that you are in programming mode.
The Armed light will turn on to indicate that the panel is waiting for the three-digit programming section number.
- Enter the three-digit section number corresponding to the section you wish to program.
The Armed light will turn off.
The Ready light will turn on to indicate that the panel is waiting for the information required to complete programming the selected section.
- Enter the information required to complete section programming (i.e., numbers, HEX data, or ON/OFF options).

Note: If the three-digit section number entered is invalid, or if the module which pertains to the section is not present, the keypad will sound a two second error tone.

From an LCD keypad:

- From any keypad, enter [*][8][Installer Code]. The Keypad will display 'Enter Section' followed by three dashes.
- Enter the three-digit number corresponding to the programming section number you wish to program. The keypad will now display the information required to complete programming the selected section.
- Enter the information required to complete section programming (i.e., numbers, HEX data, or ON/OFF options).

If you enter information into a section and make a mistake, press the [#] key to exit the section. Select that section again and re-enter the information correctly.

Note: There must be one digit in each box in the programming section in order for the change to be valid.

4.2 Programming Decimal Data

A set number of programming boxes are allotted for each section requiring decimal data (e.g.: codes, telephone numbers). If a digit is entered for each program box, the panel will automatically exit from the selected programming section. The Ready light will turn OFF and the Armed light will turn ON.

On the PC1555RKZ and PK5508 keypads, you can also press the [#] key to exit a programming section without entering data for every box. This is handy if you only need to change digits in the first few programming boxes. All other digits in the programming section will remain unchanged.

4.3 Programming HEX Data

On occasion, hexadecimal (HEX) digits may be required. To program a HEX digit, press the [*] key. The panel will enter HEX programming and the Ready light will begin to flash.

The following are the numbers that should be pressed to enter the appropriate HEX digit:

1 = A 2 = B 3 = C 4 = D 5 = E 6 = F

Once the correct HEX digit has been entered, the Ready light will continue to flash. If another HEX digit is required, press the corresponding number. If a decimal digit is required, press the [*] key again. The Ready light will turn on and the panel will return to regular decimal programming.

Example:

To enter 'C1' for a closing by user 1, you would enter:

[*][3][*], [1]:

[*] to enter Hexadecimal mode (Ready light flashes)

[3] to enter C

[*] to return to decimal mode (Ready light is solid)

[1] to enter digit 1

Note: If Ready light is flashing, any number you enter will be programmed as the HEX equivalent.

If you are using a pulse communications format, a decimal zero [0] does not transmit. Programming a zero [0] tells the panel not to send any pulses for that digit. Decimal zero [0] is a filler digit. To transmit a zero [0], it must be programmed as a Hexadecimal 'A'.

Example:

For the three digit account number '403', you would enter:

[4], [*][1][*][3], [0]:

[4] to enter the digit 4

[*] to enter Hexadecimal mode (Ready light flashes)

[1] to enter A

[*] to return to decimal mode (Ready light is solid)

[3] to enter the digit 3

[0] to enter the digit 0 as a filler digit.

4.4 Programming Toggle Option Selections

Some programming sections contain several toggle options. The panel will use zone lights 1 through 8 to indicate if the different options are enabled or disabled. Press the number corresponding to the option to turn it ON or OFF. Once all the toggle options have been selected correctly, press the [#] key to exit the section and save the changes. The Ready light will turn OFF and the Armed light will turn ON.

Refer to the Programming Worksheets in this manual to determine what each option represents and whether the light should be ON or OFF for your application.

4.5 Viewing Programming

LED and Fixed Message LCD Keypads

Any programming section can be viewed from an LED keypad. When a programming section is entered, the keypad will immediately display the first digit of information programmed in that section. The keypad displays the information using a binary format, according to the following chart.

Please See Hex Data Entry
Instructions Below

Value	0	1	2	3	4	5	6	7	8	9	A	B	C	D	E	F
Zone 1	<input type="checkbox"/>	<input checked="" type="checkbox"/>	<input type="checkbox"/>	<input checked="" type="checkbox"/>	<input type="checkbox"/>	<input checked="" type="checkbox"/>	<input type="checkbox"/>	<input checked="" type="checkbox"/>	<input type="checkbox"/>	<input checked="" type="checkbox"/>	<input type="checkbox"/>	<input checked="" type="checkbox"/>	<input type="checkbox"/>	<input checked="" type="checkbox"/>	<input type="checkbox"/>	<input checked="" type="checkbox"/>
Zone 2	<input type="checkbox"/>	<input type="checkbox"/>	<input checked="" type="checkbox"/>	<input checked="" type="checkbox"/>	<input type="checkbox"/>	<input type="checkbox"/>	<input checked="" type="checkbox"/>	<input checked="" type="checkbox"/>	<input type="checkbox"/>	<input type="checkbox"/>	<input checked="" type="checkbox"/>	<input checked="" type="checkbox"/>	<input type="checkbox"/>	<input type="checkbox"/>	<input checked="" type="checkbox"/>	<input checked="" type="checkbox"/>
Zone 3	<input type="checkbox"/>	<input type="checkbox"/>	<input type="checkbox"/>	<input type="checkbox"/>	<input checked="" type="checkbox"/>	<input checked="" type="checkbox"/>	<input checked="" type="checkbox"/>	<input checked="" type="checkbox"/>	<input type="checkbox"/>	<input type="checkbox"/>	<input type="checkbox"/>	<input checked="" type="checkbox"/>	<input checked="" type="checkbox"/>	<input checked="" type="checkbox"/>	<input checked="" type="checkbox"/>	<input checked="" type="checkbox"/>
Zone 4	<input type="checkbox"/>	<input type="checkbox"/>	<input type="checkbox"/>	<input type="checkbox"/>	<input type="checkbox"/>	<input type="checkbox"/>	<input type="checkbox"/>	<input type="checkbox"/>	<input checked="" type="checkbox"/>	<input checked="" type="checkbox"/>	<input type="checkbox"/>	<input checked="" type="checkbox"/>	<input checked="" type="checkbox"/>	<input checked="" type="checkbox"/>	<input checked="" type="checkbox"/>	<input checked="" type="checkbox"/>

Zone Light OFF
 Zone Light ON

Press the Fire keys to advance to the next digit. When all the digits in a section have been viewed, the panel will exit the section; the Ready Light will turn OFF and the Armed light will turn ON, waiting for the next three-digit programming section number to be entered. Press the [#] key to exit the section.

LCD Keypad

When a programming section is entered, the keypad will immediately display all the information programmed in that section. Use the arrow keys (<>) to scroll through the data being displayed. Scroll past the end of the data displayed or press the [#] key to exit the section.

4.6 DLS Programming

4.6.1 Local Programming with PC-Link

Follow the steps below in the sequence indicated to set up local programming using DLS:

1. Plug in PC-Link header.
2. Initiate a DLS PC-Link session on the DLS computer.
3. When the session is complete, remove the PC-Link cable from the alarm system.
4. Complete installation.

Note: Connecting the DLS PC to the system automatically initiates the connection.

5 Programming Worksheets

5.1 Index to Programming Worksheets and Descriptions

Programming Option	PWS/Desc.	Programming Option	PWS/Desc.
[000] Keypad Function Key Programming.....	16/34	[367] Opening/Closing Comm. Call Directions	25/50
[001] Zone Definitions.....	16/35	[375] System Maint. Alarm/Rest. Comm Call Dir.	25/50
[005] System Times.....	17/38	[376] System Test Trans. Comm. Call Directions.....	25/50
[006] Installer Code.....	17/38	[377] Communication Variables.....	25/50
[007] Master Code.....	17/38	[378] Test Transmission Time of Day.....	25/51
[008] Maintenance Code.....	17/38	[380] First Communicator Options.....	25/51
[009] PGM Output Prog.	17/38	[381] Second Communicator Options.....	25/52
[010] PC5208 PGM Output Prog	17/38	[382] Third Communicator Options.....	26/52
[011] PC5204 PGM Output Programming	18/38	[383] Fourth Communicator Options.....	26/53
[012] Keypad Lockout Options.....	18/40	[401] Downloading Option Codes.....	26/53
[013] First System Options	18/41	[402] Downloading Computer's Tel. Number.....	26/54
[014] Second System Options	18/41	[403] Downloading Access Code.....	26/54
[015] Third System Options	18/42	[404] Panel ID Code	27/54
[016] Fourth System Options	18/42	[405] Answering Machine Double Call Timer.....	27/54
[017] Fifth System Options	19/43	[406] Number of Rings to Answer On.....	27/54
[018] Sixth System Options	19/43	PGM Output Attributes	27/54
[020] Keypad Zone Assignments.....	19/44	[501]-[502] Main Board	27/54
[022] Ninth System Options	19/44	[503]-[510] PC5208.....	27/54
[023] Tenth System Options	19/44	[511]-[514] PC5204.....	27/54
[030] Zone Loop Response Options	20/45	[551]-[564] PGM Zone Assignment	28/55
[101]-[108] Zone Attributes	20/45	[601] Closing (Arming) Reporting Codes.....	29/55
[168] Daylight Savings Time Begins	21/46	[605] Opening (Disarming) Reporting Codes.....	29/55
[169] Daylight Savings Time Ends.....	21/46	[700] Automatic Clock Adjust.....	29/56
[170] PGM Output Timer.....	21/46	[701] First International Options.....	29/56
[175] Auto-Arm Postpone Timer.....	21/46	[702] Second International Options	29/56
[176] Cross Zone/Police Code Timer.....	22/46	[703] Delay Between Dialing Attempts	29/57
[181] Auto-Arm Time of Day	22/46	[900] Panel Version	29/57
[190] No Activity Arming Pre-Alert Timer	22/46	[901] Installer Walk Test Mode Enable/Disab.....	29/57
[191] No Activity Arming Timer	22/46	[902] Module Supervision Reset.....	29/57
[199] Auto-Arming Pre-Alert.....	22/47	[903] View Module Supervision	29/58
[301] First Telephone Number.....	22/47	[990] Installer Lockout Enable	29/58
[302] Second Telephone Number.....	22/47	[991] Installer Lockout Disable.....	29/58
[303] Third Telephone Number.....	22/47	[999] Restore Panel Factory Default Prog.....	29/58
[304] Call Waiting Cancel String.....	22/47	Local Keypad Programming	30
[305] Fourth Telephone Number.....	22/47	[000] Keypad Function Key Programming.....	30
[310] System Account Code	22/47	[001]-[008] Label Programming (Zones 1-8).....	31
[320] Alarm Rep. Codes	22/47	[065] Fire Alarm Label	31
[324] Alarm/Restore Rep. Codes.....	22/47	[066] Fail to Arm Event Message.....	31
[328] Misc. Alarm Rep. Codes.....	22/47	[067] Alarm When Armed Event Message.....	31
[329] Priority Alarm/Restore Rep. Codes.....	23/47	[071] First User Display Mask.....	31
[330] Tamper Rep. Codes	23/48	[072] Second User Display Mask.....	32
[334] Tamper Restore Rep. Codes.....	23/48	[073] Downloaded LCD Message Duration	32
[338] Misc. Tamper Rep Codes.....	23/48	[074] Key Options	32
[339]-[340] Closing (Arming) Rep. Codes.....	23/48	[076] First Keypad Options	32
[341] Misc. Closing (Arming) Rep. Codes.....	23/48	[077] Second Keypad Options.....	32
[342]-[343] Opening (Disarming) Rep. Codes	23/48	[080] PGM Terminal 1.....	33
[344] Misc. Opening (Disarming) Rep. Codes	24/48	[082] Local PGM Output Activation Time.....	33
[345] Maintenance Alarm Rep. Codes.....	24/48	[101] Partition 1 Label.....	33
[346] Maintenance Restore Rep. Codes.....	24/48	[102]-[108] Partition 2-8 Labels	33
[347] Misc. Maintenance Rep. Codes.....	24/49	[120]-[123] Partition 1 Command Output #1-4 Labels.....	33
[348] Test Transmission Rep. Codes	24/50	[201] Door Chime Zone 1	33
[350] Communicator Format Options.....	24/50	[202]-[208] Door Chime for Zones 2-8.....	33
[351] Alarm/Rest. Comm. Call Directions	24/50	[995] Res. Keypad Opt. to Fact. Def.(ALPHA LCD).....	33
[359] Tamper Alarm/Rest. Comm. Call Directions.....	24/50	[996] Reset Prog. Labels to Fact. Def.(ALPHA LCD).....	33
		[997] View Software Version (Alpha LCD only)	33
		[998] Initiate Glob Label Broadcast (Alpha LCD only).....	33
		[999] Reset All Keypad Prog. To Factory Defaults.....	33

5.2 Programming Worksheets

Keypad Partition/Slot and Function Key Programming

[000] Function Key Programming

Note: Keypad enrollment must be done at each keypad requiring programming. Function keys are programmable in each individual keypad. The keypad being programmed must be used to access Installer Programming, followed by Section [000] and digits 1-5 for function keys 1 to 5.

[0] Slot address	For the partition, 0-8; for the slot, 1-8. For example, to enroll a keypad on the main partition and slot 6, enter 16.
[1] Function Key 1 Assignment	Valid entries are 00-25
[2] Function Key 2 Assignment	Valid entries are 00-25
[3] Function Key 3 Assignment	Valid entries are 00-25
[4] Function Key 4 Assignment	Valid entries are 00-25
[5] Function Key 5 Assignment	Valid entries are 00-25

Function Key Options:

- | | | |
|---------------------------------|--|---------------------------------------|
| 00 Null Key | 09 Future Use | 18 Future Use |
| 01 Future Use | 10 Future Use | 19 [*][7][3] Command Output #3 |
| 02 Future Use | 11 Future Use | 20 Night Arm |
| 03 Stay Arm | 12 Future Use | 21 [*][7][4] Command Output #4 |
| 04 Away Arm | 13 [*][7][1] Command Output #1 | 22 Future Use |
| 05 [*][9] No Entry Arm | 14 [*][7][2] Command Output #2/Sensor Reset | 23 Future Use |
| 06 [*][4] Chime On / Off | 15 Future Use | 24 Future Use |
| 07 Future Use | 16 [*][0] Quick Exit | 25 Instant Stay Arm* |
| 08 [*][1] Bypass Mode | 17 [*][1] Reactivate Stay/Away Zones | 26-33 Future Use |

*This function key must not be used in CP-01 listed systems.

	Key 1	Key 2	Key 3	Key 4	Key 5
Keypad Defaults	03 ___	04 ___	06 ___	08 ___	16 ___

[001] Zone Definitions

- | | | |
|---------------------------------------|---|--------------------------------------|
| 00 Null Zone (Not Used) | 14 24 Hour Heat* | 28 Not Used |
| 01 Delay 1* | 15 24 Hour Medical* | 29 Not Used |
| 02 Delay 2* | 16 24 Hour Panic* | 30 Not Used |
| 03 Instant* | 17 24 Hour Emergency* | 31 Day Zone |
| 04 Interior* | 18 Not Used | 32 Instant Stay/Away* |
| 05 Interior, Stay/Away* | 19 24 Hour Water* | 33 Not Used |
| 06 Delay, Stay/Away* | 20 24 Hour Freeze* | 34 Not Used |
| 07 Delayed 24 Hr. Fire | 21 24 Hour Latching Tamper | 35 24 Hour Bell |
| 08 Standard 24 Hr. Fire | 22 Momentary Keyswitch Arm* | 36 24 Hr. Non-Latching Tamper |
| 09 24 Hour Supervisory | 23 Maintained Keyswitch Arm * | 37 Night Zone* |
| 10 24 Hour Supervisory Buzzer* | 24 Not Used | 41 24-Hour CO Detection |
| 11 24 Hour Burglary* | 25 Interior Delay* | |
| 12 Not Used | 26 24-hour Non-Alarm (Local Alarm) | |
| 13 24 Hour Gas* | 27 Not Used | |

*For burglary applications only

[001] Zone 1–8 Definitions

Zone	Default	Zone	Default
01	01	05 (ZD or keypad zone only)	04
02	03	06 (ZD or keypad zone only)	04
03	03	07 (ZD or keypad zone only)	04
04	03	08 (ZD or keypad zone only)	04

Note: If zone doubling is enabled, keypad zones will not work.

Note: If zone doubling is enabled, fire zones cannot be used with zone terminals 1 to 8. Two-wire smoke detectors can still be used.

[011] PC5204 PGM Output Programming

Default

- 01 |_____|_____| PGM 11
- 01 |_____|_____| PGM 12
- 01 |_____|_____| PGM 13
- 01 |_____|_____| PGM 14

[012] Keypad Lockout Options

Note: If Keypad Lockout is active, the panel CANNOT be disarmed with a keyswitch.

Default

- 000 |_____|_____| Number of Invalid Codes Before Lockout (Valid entries are 000-255)
- 000 |_____|_____| Lockout Duration (in minutes) (Valid entries are 000-255)

[013] First System Options

Opt.	Def.	ON	OFF
1	<input type="checkbox"/>	Normally Closed Loops	<input checked="" type="checkbox"/> <input type="checkbox"/> End-of-line Resistors
2	<input type="checkbox"/>	Double End-of-Line Resistors	<input checked="" type="checkbox"/> <input type="checkbox"/> Single End-of-line Resistors
3	<input checked="" type="checkbox"/>	Panel Shows All Troubles While Armed	<input type="checkbox"/> Panel Shows Fire Troubles While Armed
4	<input type="checkbox"/>	Tampers/Faults Do Not Show as Open	<input checked="" type="checkbox"/> <input type="checkbox"/> Tampers/Faults Show As Open
5	<input checked="" type="checkbox"/>	Auto-Arm Schedule in [*][6] + Installer Prog.	<input type="checkbox"/> Auto-Arm Schedule in Installer Prog. Only
6	<input checked="" type="checkbox"/>	Audible Exit Fault Enabled	<input type="checkbox"/> Audible Exit Fault Disabled
7	<input type="checkbox"/>	Zone Doubling Enabled	<input checked="" type="checkbox"/> <input type="checkbox"/> Zone Doubling Disabled
8	<input type="checkbox"/>	Temporal Three Fire Signal Enabled	<input checked="" type="checkbox"/> <input type="checkbox"/> Standard Pulsed Fire Signal

Note: When Option 7 is ON, the configuration of Options 1 and 2 should be ignored.

[014] Second System Options

Opt.	Def.	ON	OFF
1	<input type="checkbox"/>	Arm/Disarm Squawk Enabled	<input checked="" type="checkbox"/> <input type="checkbox"/> Arm/Disarm Squawk Disabled
2	<input type="checkbox"/>	Bell Squawk During Auto Arm On	<input checked="" type="checkbox"/> <input type="checkbox"/> Bell Squawk During Auto Arm Off
3	<input type="checkbox"/>	For Future Use	<input checked="" type="checkbox"/> <input type="checkbox"/>
4	<input type="checkbox"/>	For Future Use	<input checked="" type="checkbox"/> <input type="checkbox"/>
5	<input type="checkbox"/>	For Future Use	<input checked="" type="checkbox"/> <input type="checkbox"/>
6	<input type="checkbox"/>	For Future Use	<input checked="" type="checkbox"/> <input type="checkbox"/>
7	<input type="checkbox"/>	Exit Delay Termination Enabled	<input checked="" type="checkbox"/> <input type="checkbox"/> Exit Delay Termination Disabled
8	<input type="checkbox"/>	Fire Bell is Continuous	<input checked="" type="checkbox"/> <input type="checkbox"/> Fire Bell Follows Bell Cut-off

[015] Third System Options

Opt.	Def.	ON	OFF
1	<input checked="" type="checkbox"/>	<input type="checkbox"/> [F] Key Enabled	<input type="checkbox"/> [F] Key Disabled
2	<input type="checkbox"/>	<input type="checkbox"/> [P] Key Audible (Bell/Beeps)	<input checked="" type="checkbox"/> <input type="checkbox"/> [P] Key Silent
3	<input type="checkbox"/>	Quick Exit Enabled	<input checked="" type="checkbox"/> <input type="checkbox"/> Quick Exit Disabled
4	<input checked="" type="checkbox"/>	Quick Arming Enabled ([*][0] and Function Keys)	<input type="checkbox"/> Quick Arming Disabled (Function Key Requires Code)
5	<input type="checkbox"/>	Code Required for Bypassing	<input checked="" type="checkbox"/> <input type="checkbox"/> No Code Required
6	<input type="checkbox"/>	Master Code Not Changeable	<input checked="" type="checkbox"/> <input type="checkbox"/> Master Code Changeable
7	<input checked="" type="checkbox"/>	TLM Enabled	<input type="checkbox"/> TLM Disabled
8	<input type="checkbox"/>	For Future Use	<input checked="" type="checkbox"/> <input type="checkbox"/>

[016] Fourth System Options

Opt.	Def.	ON	OFF
1	<input checked="" type="checkbox"/>	<input type="checkbox"/> AC Trouble Displayed	<input type="checkbox"/> AC Trouble Not Displayed
2	<input type="checkbox"/>	Trouble Light Flashes if AC Fails	<input checked="" type="checkbox"/> <input type="checkbox"/> Trouble Light Does Not Flash if AC Fails
3	<input type="checkbox"/>	Blank Keypad When Not Used	<input checked="" type="checkbox"/> <input type="checkbox"/> Keypad Always Active
4	<input type="checkbox"/>	Code Required to Remove Keypad Blanking	<input checked="" type="checkbox"/> <input type="checkbox"/> No Code Required

- | | | | | | | |
|---|---|--------------------------|-------------------------------------|--------------------------|------------------------------|---|
| 5 | ✓ | <input type="checkbox"/> | Keypad Backlighting Enabled | <input type="checkbox"/> | Keypad Backlighting Disabled | |
| 6 | | <input type="checkbox"/> | Power Save Mode Enabled | ✓ | <input type="checkbox"/> | Power Save Mode Disabled |
| 7 | | <input type="checkbox"/> | Bypass Status Displayed While Armed | ✓ | <input type="checkbox"/> | Bypass Status Not Displayed While Armed |
| 8 | | <input type="checkbox"/> | Keypad Tamper Enabled | ✓ | <input type="checkbox"/> | Keypad Tamper Disabled |

[017] Fifth System Options

- | Opt. | Def. | ON | OFF |
|------|------|--|---|
| 1 | | <input type="checkbox"/> For Future Use | ✓ <input type="checkbox"/> |
| 2 | | <input type="checkbox"/> For Future Use | ✓ <input type="checkbox"/> |
| 3 | | <input type="checkbox"/> For Future Use | ✓ <input type="checkbox"/> |
| 4 | | <input type="checkbox"/> Double Hit Enabled | ✓ <input type="checkbox"/> Double Hit Disabled |
| 5 | | <input type="checkbox"/> Late to Close Enabled | ✓ <input type="checkbox"/> Late to Close Disabled |
| 6 | | <input type="checkbox"/> Daylight Savings Time Enabled | ✓ <input type="checkbox"/> Daylight Savings Time Disabled |
| 7 | | <input type="checkbox"/> For Future Use | ✓ <input type="checkbox"/> |
| 8 | | <input type="checkbox"/> For Future Use | ✓ <input type="checkbox"/> |

[018] Sixth System Options

- | Opt. | Def. | ON | OFF |
|------|------|--|--|
| 1 | | <input type="checkbox"/> For Future Use | ✓ <input type="checkbox"/> |
| 2 | | <input type="checkbox"/> For Future Use | ✓ <input type="checkbox"/> |
| 3 | | <input type="checkbox"/> For Future Use | ✓ <input type="checkbox"/> |
| 4 | | <input type="checkbox"/> For Future Use | ✓ <input type="checkbox"/> |
| 5 | | <input type="checkbox"/> Keypad Buzzer Follows Bell Enabled | ✓ <input type="checkbox"/> Keypad Buzzer Follows Bell Disabled |
| 6 | | <input type="checkbox"/> Cross Zoning Enabled | ✓ <input type="checkbox"/> Cross Zoning Disabled (Police Code Enabled) |
| 7 | | <input type="checkbox"/> Exit Delay Restart Enabled | ✓ <input type="checkbox"/> Exit Delay Restart Disabled |
| 8 | | <input type="checkbox"/> System AC Failure Trouble Beeps Enabled | ✓ <input type="checkbox"/> System AC Failure Trouble Beeps Disabled |

[020] Keypad Zone Assignments**Default**

- | | | | | |
|----|-------|-------|-------------------------|---------------------------------|
| 00 | _____ | _____ | Keypad (Address 1) Zone | (Valid entries are Zones 01–08) |
| 00 | _____ | _____ | Keypad (Address 2) Zone | |
| 00 | _____ | _____ | Keypad (Address 3) Zone | |
| 00 | _____ | _____ | Keypad (Address 4) Zone | |
| 00 | _____ | _____ | Keypad (Address 5) Zone | |
| 00 | _____ | _____ | Keypad (Address 6) Zone | |
| 00 | _____ | _____ | Keypad (Address 7) Zone | |
| 00 | _____ | _____ | Keypad (Address 8) Zone | |

[022] Ninth System Options

- | Opt | Def. | ON | OFF |
|-----|------|--|---|
| 1 | | <input type="checkbox"/> For Future Use | ✓ <input type="checkbox"/> |
| 2 | | <input type="checkbox"/> For Future Use | ✓ <input type="checkbox"/> |
| 3 | | <input type="checkbox"/> For Future Use | ✓ <input type="checkbox"/> |
| 4 | | <input type="checkbox"/> For Future Use | ✓ <input type="checkbox"/> |
| 5 | | <input type="checkbox"/> For Future Use | ✓ <input type="checkbox"/> |
| 6 | | <input type="checkbox"/> For Future Use | ✓ <input type="checkbox"/> |
| 7 | | <input type="checkbox"/> For Future Use | ✓ <input type="checkbox"/> |
| 8 | | <input type="checkbox"/> Stay Arming Exit Delay is Audible | ✓ <input type="checkbox"/> Stay Arming Exit Delay is Silent |

[023] Tenth System Options

- | Opt | Def. | ON | OFF |
|-----|------|---|---|
| 1 | | <input type="checkbox"/> For Future Use | ✓ <input type="checkbox"/> |
| 2 | | <input type="checkbox"/> For Future Use | ✓ <input type="checkbox"/> |
| 3 | | <input type="checkbox"/> For Future Use | ✓ <input type="checkbox"/> |
| 4 | | <input type="checkbox"/> For Future Use | ✓ <input type="checkbox"/> |
| 5 | | <input type="checkbox"/> Switching from Away to Stay Disabled | ✓ <input type="checkbox"/> Away to Stay Toggle Option Permitted |
| 6 | | <input type="checkbox"/> For Future Use | ✓ <input type="checkbox"/> |

- 7 Trouble Beeps are Silent
- 8 Keyswitch Arms In Away Mode Only

- ✓ Trouble Beeps Sound Every 10 seconds
- ✓ Keyswitch Arms In Stay or Away Modes

[030] Zone Loop Response Options

Opt Def. ON

OFF

- 1 Zone 1 is Fast Loop Response
- 2 Zone 2 is Fast Loop Response
- 3 Zone 3 is Fast Loop Response
- 4 Zone 4 is Fast Loop Response

- ✓ Zone 1 is Normal Loop Response
- ✓ Zone 2 is Normal Loop Response
- ✓ Zone 3 is Normal Loop Response
- ✓ Zone 4 is Normal Loop Response

[101]-[108] Zone Attributes

- [101] Zone 1 Attributes
- [102] Zone 2 Attributes
- [103] Zone 3 Attributes
- [104] Zone 4 Attributes
- [105] Zone 5 Attributes
- [106] Zone 6 Attributes
- [107] Zone 7 Attributes
- [108] Zone 8 Attributes

Zone Attribute Defaults

Attribute:	1	2	3	4	5	6	7	8
✓ =ON	Audible	Steady	Chime	Bypass	Force	Swing	Tx. Delay	Not used
Zone Type:	OFF	Silent	Pulsed	No	No	No	No	No
00 Null Zone								
01 Delay 1	✓	✓	✓	✓		✓		
02 Delay 2	✓	✓	✓	✓		✓		
03 Instant	✓	✓	✓	✓		✓		
04 Interior	✓	✓		✓		✓		
05 Interior Stay/Away	✓	✓		✓	✓	✓		
06 Delay Stay/Away	✓	✓		✓	✓	✓		
07 Delay 24-hr. Fire (Hardwired)	✓							
08 Stand 24-hr. Fire (Hardwired)	✓							
09 24-hr. Supervisory (Hardwired)		✓			✓			
10 24-hr. Supervisory Buzzer		✓		✓				
11 24-hr. Burglary	✓	✓		✓				
12 Not Used								
13 24-hr. Gas	✓							
14 24-hr. Heat	✓							
15 24-hr. Medical	✓	✓						
16 24-hr. Panic	✓	✓						
17 24-hr. Emergency	✓	✓						
18 Not Used								
19 24-hr. Water	✓	✓						
20 24-hr. Freeze	✓	✓						
21 24-hr. Latching Tamper	✓	✓						
22 Momentary Keyswitch Arm					✓			
23 Maintained Keyswitch (Hardwired)					✓			
24 Not Used								
25 Interior Delay	✓	✓		✓		✓		
26 24-hr. Non-Alarm					✓			
27-30 Not Used								
31 Day Zone	✓	✓		✓	✓	✓	✓	
32 Instant Stay/Away	✓	✓		✓		✓		
33-34 Not Used								
35 24-hr. Bell/Buzzer Zone Type	✓	✓		✓		✓		
36 24-hr. Non-Latching Tamper		✓				✓		
37 Night Zone	✓	✓		✓	✓	✓		
41 24-hr. Carbon Monoxide Detection	✓							

* For UL installations, do not change attribute 5 (Force Arming) from the default setting. For CP-01 installations: Option 6 (Swinger) is defaulted ON for zone definitions 09-11, 13-17, 19, 20. Option 7 (Tx Delay) is defaulted ON for zone definitions 01-06, 09-11, 13-17, 19, 20, 25, 32, 36, 37.

Attribute:	9	10	11	12	13	14	15	16
✓ =ON	Cross Zn	Zone Attributes 10-13 for Future Use				NC Loops	SEOL	DEOL
Zone Type: OFF	No					Config.	Config.	Config.
00 Null Zone								
01 Delay 1								
02 Delay 2								
03 Instant								
04 Interior								
05 Interior Stay/Away								
06 Delay Stay/Away								
07 Delay 24-hr. Fire (Hardwired)								
08 Stand 24-hr. Fire (Hardwired)								
09 24-hr. Supervisory (Hardwired)								
10 24-hr. Supervisory Buzzer								
11 24-hr. Burglary								
12 Not Used								
13 24-hr. Gas								
14 24-hr. Heat								
15 24-hr. Medical								
16 24-hr. Panic								
17 24-hr. Emergency								
18 Not Used								
19 24-hr. Water								
20 24-hr. Freeze								
21 24-hr. Latching Tamper								
22 Momentary Keyswitch Arm								
23 Maintained Keyswitch (Hardwired)								
24 Not Used								
25 Interior Delay								
26 24-hr. Non-Alarm								
27-30 Not Used								
31 Day Zone								
32 Instant Stay/Away								
33-34 Not Used								
35 24-hr. Bell/Buzzer Zone Type								
36 24-hr. Non-Latching Tamper								
37 Night Zone								
41 24-hr. Carbon Monoxide Detection								

[168] Daylight Saving Time Begins

[169] Daylight Saving Time Ends

Default	EU Default		Valid entries	Default	EU Default		Valid entries
003	003	Month	_____	011	010	Month	_____
			001-012				001-012
002	005	Week	_____	001	005	Week	_____
			000-005				000-005
000	000	Day	_____	000	000	Day	_____
			000-031				000-031
002	001	Hour	_____	002	001	Hour	_____
			000-023				000-023
001	001	Increment	_____	001	001	Decrement	_____
			001-002				001-002

[170] PGM Output Timer

Default 005 _____

Valid entries are 001-255 seconds

[175] Auto-arm Postpone Timer

Default 000 _____

Valid entries are 000-255 seconds, 000 to disable

[176] Cross Zone/Police Code Timer

Default 060 | | | | | |

Valid entries are 000-255 seconds/minutes

[181] Auto-Arm Time of Day

Default 99:99 | | | | | | | |

Valid entries are 0000-2359 hrs, 9999 to disable

[190] No Activity Arming Pre-alert Timer

Default 001 | | | | | |

Valid entries are 001-255 minutes, 000 for no pre-alert

[191] System No Activity Arming Timer

Default 000 | | | | | |

Valid entries are 001-255 minutes, 000 to disable

[199] Auto-Arming Pre-Alert Timer

Default 004 | | | | | |

Valid entries are 001-255 minutes, 000 to disable

Communications

i For Sections [301] to [348], the content of every section by default is [F].

[301] First Telephone Number (32 Digits) (Program all unused digits with Hex F)

| **D** | | | | | | | | | | | | | | | | | | | | | | | | | | | | | | | | | | | | | | | | |

[302] Second Telephone Number (32 Digits)

| **D** | | | | | | | | | | | | | | | | | | | | | | | | | | | | | | | | | | | | | | | | |

[303] Third Telephone Number (32 Digits)

| **D** | | | | | | | | | | | | | | | | | | | | | | | | | | | | | | | | | | | | | | | | |

[304] Call Waiting Cancel String (6 Digits)

| | | | | | | | Default = DB70EF Program unused digits with Hex F

[305] Fourth Telephone Number (32 Digits)

| **D** | | | | | | | | | | | | | | | | | | | | | | | | | | | | | | | | | | | | | | | | |

[310] System Account Code (6 Digits)

Enter a 4 or 6-digit account number for the system account code. Only SIA supports 6-digit account codes. If a 4-digit code is used, program the last two digits of the account code with FF.

Default = FFFFFFFF | | | | | | | |

Reporting Codes

i All Reporting Codes are defaulted "FF" unless indicated otherwise.

[320] Alarm Reporting Codes, Zones 01-08

Section

[320]	Zone 01	Zone 02	Zone 03	Zone 04	Zone 05	Zone 06	Zone 07	Zone 08

[324] Alarm Restore Reporting Codes, Zones 01-08

Section

[324]	Zone 01	Zone 02	Zone 03	Zone 04	Zone 05	Zone 06	Zone 07	Zone 08

[328] Miscellaneous Alarm Reporting Codes

- | | | | Duress Alarm
- | | | | Opening After Alarm
- | | | | Recent Closing
- | | | | Zone Expander Supervisory Alarm
- | | | | Zone Expander Supervisory Restore
- | | | | Cross Zone/Police Code Alarm
- | | | | Burglary Not Verified
- | | | | Alarm Cancelled

[329] Priority Alarm and Restore Reporting Codes

- |_|_| Keypad [F] Fire Alarm
- |_|_| Keypad [A] Auxiliary Alarm
- |_|_| Keypad [P] Panic Alarm
- |_|_| Auxiliary Input Alarm
- |_|_| Keypad [F] Fire Restore
- |_|_| Keypad [A] Auxiliary Restore
- |_|_| Keypad [P] Panic Restore
- |_|_| Auxiliary Input Restore

[330] Tamper Reporting Codes, Zones 01-08

Section

[330]	Zone 01	Zone 02	Zone 03	Zone 04	Zone 05	Zone 06	Zone 07	Zone 08
	_ _	_ _	_ _	_ _	_ _	_ _	_ _	_ _

[334] Tamper Restore Reporting Codes, Zones 01-08

Section

[334]	Zone 01	Zone 02	Zone 03	Zone 04	Zone 05	Zone 06	Zone 07	Zone 08
	_ _	_ _	_ _	_ _	_ _	_ _	_ _	_ _

[338] Miscellaneous Tamper Reporting Codes

- |_|_| General System Tamper
- |_|_| General System Tamper Restore
- |_|_| Keypad Lockout

[339] Closing (Arming) Reporting Codes, Access Codes 1-16

Section

[339]	Code 1	Code 2	Code 3	Code 4	Code 5	Code 6	Code 7	Code 8
	_ _	_ _	_ _	_ _	_ _	_ _	_ _	_ _
	Code 9	Code 10	Code 11	Code 12	Code 13	Code 14	Code 15	Code 16
	_ _	_ _	_ _	_ _	_ _	_ _	_ _	_ _

[340] Closing (Arming) Reporting Codes, Access Codes 17-32

Section

[340]	Code 17	Code 18	Code 19	Code 20	Code 21	Code 22	Code 23	Code 24
	_ _	_ _	_ _	_ _	_ _	_ _	_ _	_ _
	Code 25	Code 26	Code 27	Code 28	Code 29	Code 30	Code 31	Code 32
	_ _	_ _	_ _	_ _	_ _	_ _	_ _	_ _

[341] Miscellaneous Closing (Arming) Reporting Codes

- | | | | |
|-----|-------------------------------------|-----|-----------------|
| _ _ | For Future Use | _ _ | Partial Closing |
| _ _ | For Future Use | _ _ | Special Closing |
| _ _ | For Future Use | _ _ | Late to Close |
| _ _ | For Future Use | _ _ | Exit Fault |
| _ _ | Automatic Zone Bypass, Default = 00 | | |

[342] Opening (Disarming) Reporting Codes, Access Codes 1-16

Code 1	Code 2	Code 3	Code 4	Code 5	Code 6	Code 7	Code 8
_ _	_ _	_ _	_ _	_ _	_ _	_ _	_ _
Code 9	Code 10	Code 11	Code 12	Code 13	Code 14	Code 15	Code 16
_ _	_ _	_ _	_ _	_ _	_ _	_ _	_ _

[343] Opening (Disarming) Reporting Codes, Access Codes 17-32

Code 17	Code 18	Code 19	Code 20	Code 21	Code 22	Code 23	Code 24
□□□	□□□	□□□	□□□	□□□	□□□	□□□	□□□
Code 25	Code 26	Code 27	Code 28	Code 29	Code 30	Code 31	Code 32
□□□	□□□	□□□	□□□	□□□	□□□	□□□	□□□

[344] Miscellaneous Opening (Disarming) Reporting Codes

□□□	For Future Use	□□□	For Future Use
□□□	For Future Use	□□□	Auto-Arm Cancel/Postpone
□□□	For Future Use	□□□	Special Opening
□□□	For Future Use	□□□	For Future Use

[345] Maintenance Alarm Reporting Codes

□□□	Battery Trouble Alarm	□□□	Auxiliary Power Supply Trouble Alarm
□□□	AC Failure Trouble Alarm	□□□	For Future Use
□□□	Bell Circuit Trouble	□□□	General System Trouble
□□□	Fire Trouble Alarm	□□□	General System Supervisory

[346] Maintenance Alarm Restore Reporting Codes

□□□	Battery Trouble Restore	□□□	TLM Restore
□□□	AC Failure Trouble Restore	□□□	General System Trouble Restore
□□□	Bell Circuit Trouble Restore	□□□	General System Supervisory Restore
□□□	Fire Trouble Restore	□□□	System Reset (Cold Start)
□□□	Auxiliary Power Supply Trouble Restore		

[347] Miscellaneous Maintenance Reporting Codes

□□□	Telephone #1 FTC Restore	□□□	Delinquency Reporting Code
□□□	Telephone #2 FTC Restore	□□□	For Future Use
□□□	Event Buffer 75% Full	□□□	For Future Use
□_0_□_0_□	DLS Lead IN	□_0_□_0_□	Installer Lead Out
□_0_□_0_□	DLS Lead OUT	□_0_□_0_□	Installer Lead In
□□□	General Zone Fault Alarm	□□□	Telephone #3 FTC Restore
□□□	General Zone Fault Restore	□□□	Telephone #4 FTC Restore

[348] Test Transmission Reporting Codes

□□□	Walk Test End	□□□	Periodic Test Transmission
□□□	Walk Test Begin	□□□	System Test

[350] Communicator Format Options

1st Telephone Number	2nd Telephone Number	3rd Telephone Number	4th Telephone Number
Default 04 □□□	Default 04 □□□	Default 04 □□□	Default 04 □□□
01 20 BPS, 1400 Hz	02 20 BPS, 2300 Hz	03 DTMF Contact ID	04 SIA FSK
06* Residential Dial	07 10 BPS, 1400Hz	08 10 BPS, 2300Hz	09 Private Line

*Failure to communicate using Residential Dial will not generate an FTC trouble.

[351] Alarm/Restore Communicator Call Directions

Option 1 First Telephone Number (Default ON)	Option 2 Second Telephone Number (Default OFF)	Option 3 Third Telephone Number (Default OFF)	Option 4 Fourth Telephone Number (Default OFF)	Option 5-8 Future Use (Default ON)
✓	□	□	□	□

[359] Tamper Alarm/Restore Communicator Call Directions

Option 1 First Telephone Number (Default ON)	Option 2 Second Telephone Number (Default OFF)	Option 3 Third Telephone Number (Default OFF)	Option 4 Fourth Telephone Number (Default OFF)	Option 5-8 Future Use (Default ON)
✓	□	□	□	□

[367] Opening/Closing Communicator Call Directions

Option 1 First Telephone Number (Default OFF)	Option 2 Second Telephone Number (Default OFF)	Option 3 Third Telephone Number (Default OFF)	Option 4 Fourth Telephone Number (Default OFF)	Option 5-8 Future Use (Default OFF)
<input type="checkbox"/>	<input type="checkbox"/>	<input type="checkbox"/>	<input type="checkbox"/>	<input type="checkbox"/>

[375] System Maintenance Alarm/Restore Communicator Call Directions

Option 1 First Telephone Number (Default ON)	Option 2 Second Telephone Number (Default OFF)	Option 3 Third Telephone Number (Default OFF)	Option 4 Fourth Telephone Number (Default OFF)	Option 5-8 Future Use (Default ON)
✓	<input type="checkbox"/>	<input type="checkbox"/>	<input type="checkbox"/>	<input type="checkbox"/>

[376] System Test Transmissions/Communicator Call Directions

Option 1 First Telephone Number (Default ON)	Option 2 Second Telephone Number (Default OFF)	Option 3 Third Telephone Number (Default OFF)	Option 4 Fourth Telephone Number (Default OFF)	Option 5-8 Future Use (Default OFF)
✓	<input type="checkbox"/>	<input type="checkbox"/>	<input type="checkbox"/>	<input type="checkbox"/>

[377] Communication Variables

Default EU
Default

003		<u> </u> <u> </u> <u> </u> <u> </u>	Swinger Shutdown (Alarms and Rest)	001-014 Transmissions, 000=disabled
003		<u> </u> <u> </u> <u> </u> <u> </u>	Swinger Shutdown (Tampers and Rest)	001-014 Transmissions, 000=disabled
003		<u> </u> <u> </u> <u> </u> <u> </u>	Swinger Shutdown (Maint. and Rest)	001-014 Transmissions, 000=disabled
000		<u> </u> <u> </u> <u> </u> <u> </u>	Communication Delay	000-255 seconds
030		<u> </u> <u> </u> <u> </u> <u> </u>	AC Failure Communication Delay	000-255 minutes/hours
010	002	<u> </u> <u> </u> <u> </u> <u> </u>	TLM Trouble Delay	(# of valid checks required 10 x 3s)
030		<u> </u> <u> </u> <u> </u> <u> </u>	Test Transmission Cycle (land line)	001-255 hours/days, 000=disabled
007		<u> </u> <u> </u> <u> </u> <u> </u>	Future Use	Future Use
030		<u> </u> <u> </u> <u> </u> <u> </u>	Delinquency Transmission Delay	001-255 days/hours, 000=disabled
000		<u> </u> <u> </u> <u> </u> <u> </u>	Communications Cancelled Window	005-255 minutes (CP-01 Only)

[378] Test Transmission Time of Day

Default

9999 (Valid entries are 0000-2359, 9999 to disable)

[380] First Communicator Options

Opt	Def.	ON	OFF
1	✓	<input type="checkbox"/> Communications Enabled	<input type="checkbox"/> Communications Disabled
2		<input type="checkbox"/> Restores on Bell Time-out	✓ <input type="checkbox"/> Restores Follow Zones
3		<input type="checkbox"/> Pulse Dialing	✓ <input type="checkbox"/> DTMF Dialing
4		<input type="checkbox"/> Switch to Pulse Dialing after 4 Attempts	✓ <input type="checkbox"/> DTMF Dial for all Attempts
5		<input type="checkbox"/> For Future Use	✓ <input type="checkbox"/>
6		<input type="checkbox"/> Alternating Backup Dialing Enabled	✓ <input type="checkbox"/> Call Primary Number, Backup to Secondary
7		<input type="checkbox"/> For Future Use	✓ <input type="checkbox"/>
8		<input type="checkbox"/> Delinquency Follows Zone Activity (Hours)	✓ <input type="checkbox"/> Delinquency Follows Arming (Days)

[381] Second Communicator Options

Opt.	Def.	ON	OFF
1		<input type="checkbox"/> Opening After Alarm Keypad Ringback Enabled	✓ <input type="checkbox"/> Opening After Alarm Ringback Disabled
2		<input type="checkbox"/> For Future Use	✓ <input type="checkbox"/>

[404] Panel ID Code (Enter 6 Hexadecimal Digits)

_____ Default = 140400

[405] Answering Machine Double-Call Timer

Default 060 _____ Valid entries are 000-255 seconds

[406] Number of Rings To Answer On

Default 000 _____ Valid entries are 000-255 rings

[501]-[514] PGM Output Attributes

Program only the following attributes for the PGM options listed. All others are ignored.

Main board		
[501]	PGM 1	_____
[502]	PGM 2	_____
PC5208		
[503]	PGM 3	_____
[504]	PGM 4	_____
[505]	PGM 5	_____
[506]	PGM 6	_____
[507]	PGM 7	_____
[508]	PGM 8	_____
[509]	PGM 9	_____
[510]	PGM 10	_____
PC5204		
[511]	PGM 11	_____
[512]	PGM 12	_____
[513]	PGM 13	_____
[514]	PGM 14	_____

PGM Option	✓ =ON OFF	1 Not Used -	2 Not Used -	3 True Output Inverted	4 Follows Timer ON/OFF	5 Code Req. No Code	6 Not Used No	7 Not Used No	8 Not Used No
Attribute:									
00	Null PGM (Not Used)								
01	Burglary and Fire Siren Output			✓					
02	Not Used								
03	Sensor Reset (*72)			✓					
04	2-Wire Smoke Support (PGM 2 Only)			✓					
05	Armed Status			✓					
06	Ready To Arm			✓					
07	Keypad Buzzer Follow			✓					
08	Courtesy Pulse			✓					
11	System Tamper			✓					
12	TLM and Alarm			✓					
13	Kiss-off Output			✓					
14	Ground Start Pulse			✓					
15	Remote Operation			✓					
16	Not Used								
17	Away Armed Status			✓					
18	Stay Armed Status			✓					
19	Command Output #1 [*][7][1]			✓	✓	✓			
20	Command Output #2 [*][7][2]			✓	✓				
21	Command Output #3 [*][7][3]			✓	✓				
22	Command Output #4 [*][7][4]			✓	✓				
23	For Future Use								
24	For Future Use								
25	Delayed Burglary and Fire Bell Output			✓					
26	Battery Test Output			✓					

PGM Option	✓ =ON OFF	1 Not Used -	2 Not Used -	3 True Output Inverted	4 Follows Timer ON/OFF	5 Code Req. No Code	6 Not Used No	7 Not Used No	8 Not Used No
27	Police Code			✓					
28	For Future Use								
29	Zone Follower			✓					
30	Status Alarm Memory			✓					
		Notes:		A change of default setting will NOT affect the output.					
				A change of default setting will affect the output.					

Attribute:	1	2	3	4	5	6	7	8
ON OFF	Service Req. Event	AC Fail	TLM Fault	FTC Enabled	Device Fault	Device Tamper	Device Low Battery	Loss of Clock
	Disabled	Disabled	Disabled	Disabled	Disabled	Disabled	Disabled	Disabled
09 System Trouble	✓	✓	✓	✓	✓	✓	✓	✓

Attribute:	1	2	3	4	5	6	7	8
ON OFF	Burglary Event	Fire Event	Panic Event	Medical Event	Supervisory Event	Priority Event	Duress Event	Output Follows Timer
	Disabled	Disabled	Disabled	Disabled	Disabled	Disabled	Disabled	Disabled
10 System Event	✓	✓	✓	✓	✓	✓	✓	

Note: If a System Event PGM is programmed to follow the Command Output Timer, attribute 8 must be enabled.

Location	PGM 29 Zone Follower	
	Option On	Option Off
Option 1	For Future Use	
Option 2	For Future Use	
Option 3	True Output	Inverted
Option 4	For Future Use	
Option 5	For Future Use	
Option 6	For Future Use	
Option 7	For Future Use	
Option 8	AND Logic	Or Logic

Zone Follower PGM requires 2 programming sections for attributes: the normal PGM attribute Sections [501-514] and Sections [551-564] for zone assignment.

[551]-[564] PGM Zone Assignment

Section Number	Output Number	Zone Follower Zone							
		1	2	3	4	5	6	7	8
Main Board									
[551]	PGM 1								
[552]	PGM 2								
PC5208									
[553]	PGM 3								
[554]	PGM 4								
[555]	PGM 5								
[556]	PGM 6								
[557]	PGM 7								
[558]	PGM 8								
[559]	PGM 9								
[560]	PGM 10								

Section Number	Output Number	Zone Follower Zone							
PC5204									
[561]	PGM 11								
[562]	PGM 12								
[563]	PGM 13								
[564]	PGM 14								

[601] Closing (Arming) Reporting Codes, Access Codes 33-40

Code 33 Code 34 Code 35 Code 36 Code 37 Code 38 Code 39 Code 40

[605] Opening (Disarming) Reporting Codes, Access Codes 33-40

Code 33 Code 34 Code 35 Code 36 Code 37 Code 38 Code 39 Code 40

INTERNATIONAL PROGRAMMING

[700] Automatic Clock Adjustment

Default = 60 Valid Entries 00-99 Seconds

[701] First International Options

Note: Programming options indicated in grey are EU defaults.

- | Opt | Def. | ON | OFF |
|-----|-------------------------------------|--|---|
| 1 | <input checked="" type="checkbox"/> | <input type="checkbox"/> 50 Hz AC | <input checked="" type="checkbox"/> <input type="checkbox"/> 60 Hz AC |
| 2 | <input type="checkbox"/> | <input type="checkbox"/> Time Base - Internal Crystal | <input checked="" type="checkbox"/> <input type="checkbox"/> Time Base - AC Line |
| 3 | <input type="checkbox"/> | <input type="checkbox"/> AC/DC Arming Inhibit Enabled | <input checked="" type="checkbox"/> <input type="checkbox"/> AC/DC Arming Inhibit Disabled |
| 4 | <input type="checkbox"/> | <input type="checkbox"/> All System Tamper Require Installer Reset | <input checked="" type="checkbox"/> <input type="checkbox"/> All System Tamper Follow Restore |
| 5 | <input type="checkbox"/> | <input type="checkbox"/> 6-digit User Access Codes | <input checked="" type="checkbox"/> <input type="checkbox"/> 4-digit User Access Codes |
| 6 | <input type="checkbox"/> | <input type="checkbox"/> Busy Tone Detection Enabled | <input checked="" type="checkbox"/> <input type="checkbox"/> Busy Tone Detection Disabled |
| 7-8 | <input type="checkbox"/> | <input type="checkbox"/> For Future Use | <input checked="" type="checkbox"/> <input type="checkbox"/> |

[702] Second International Options

- | Opt | Def. | ON | OFF |
|-----|-------------------------------------|--|--|
| 1 | <input type="checkbox"/> | <input type="checkbox"/> Pulse Dialing Make/Break Ratio is 33/67 | <input checked="" type="checkbox"/> <input type="checkbox"/> Pulse Dialing Make/Break Ratio is 40/60 |
| 2 | <input checked="" type="checkbox"/> | <input type="checkbox"/> Force Dialing Enabled | <input type="checkbox"/> Force Dialing Disabled |
| 3 | <input type="checkbox"/> | <input type="checkbox"/> For Future Use | <input checked="" type="checkbox"/> <input type="checkbox"/> |
| 4 | <input type="checkbox"/> | <input type="checkbox"/> 1600Hz Handshake | <input checked="" type="checkbox"/> <input type="checkbox"/> Standard Handshake |
| 5 | <input type="checkbox"/> | <input type="checkbox"/> ID Tone Enabled | <input checked="" type="checkbox"/> <input type="checkbox"/> ID Tone Disabled |
| 6 | <input type="checkbox"/> | <input type="checkbox"/> 2100 Hz ID Tone | <input checked="" type="checkbox"/> <input type="checkbox"/> 1300 Hz ID Tone |
| 7 | <input type="checkbox"/> | <input type="checkbox"/> For Future Use | <input checked="" type="checkbox"/> <input type="checkbox"/> |
| 8 | <input type="checkbox"/> | <input type="checkbox"/> For Future Use | <input checked="" type="checkbox"/> <input type="checkbox"/> |

[703] Delay Between Dialing Attempts

Default = 003 Valid entries are 000-255 seconds (entry + 5 seconds)

[900] Panel Version

Not Programmable

[901] Installer Walk Test Mode Enable/Disable

See [901] Installer Walk Test Mode Enable/Disable.

[902] Module Supervision Reset

See [902] Module Supervision Reset.

[903] View Module Supervision

See [903] View Module Supervision.

[990] Installer Lockout Enable

Enter [990] [Installer's Code] [990]

[991] Installer Lockout Disable

Enter [991] [Installer's Code] [991]

[999] Restore Panel Factory Defaults

Enter [999] [Installer's Code] [999]

Programming PK5500 Keypads

If you have an PK5500 keypad, additional programming is required for proper operation. All LCD programming is done per keypad. If more than one LCD keypad is present on the system, labels programmed at one keypad can be broadcast to all other LCD keypads. The following is a description of the available programming options and their accompanying programming sections:

How to Enter LCD Programming

Programming LCD keypads is similar to programming the rest of the system. Follow the programming procedure as outlined in Section 3 of the *Installation Manual*.

1. Enter keypad programming by pressing [*][8][Installer Code].
2. Press the [*] key.
3. Enter the three-digit section number to be programmed (see the following for section numbers).

Programmable Labels

Zone labels and other LCD display identifiers can be customized to make operation of the system easier for the end user. The following procedure should be used for creating all LCD labels:

1. Enter Installer Programming. Enter the three-digit section number for the label to be programmed.
2. Use the arrow keys (<>) to move the underline bar underneath the letter to be changed.
3. Press the number key [1] to [9] corresponding to the letter you require. The first time you press the number the first letter will appear. Pressing the number key again will display the next letter.

Refer to the following chart:

[1] - A, B, C, 1	[6] - P, Q, R, 6
[2] - D, E, F, 2	[7] - S, T, U, 7
[3] - G, H, I, 3	[8] - V, W, X, 8
[4] - J, K, L, 4	[9] - Y, Z, 9, 0
[5] - M, N, O, 5	[0] - Space

4. When the required letter or number is displayed use the arrow keys (<>) to scroll to the next letter.
5. When you are finished programming the Zone Label, press the [*] key, scroll to "Save," then press [*].
6. Continue from Step 2 until all Labels are programmed.

[000] Keypad Function Key Programming

The five function keys on the alarm panel can be reprogrammed as described below. See How to Program Function Keys for default.

[1]	Function Key 1 Assignment	(Valid entries are 00-25)
[2]	Function Key 2 Assignment	(Valid entries are 00-25)
[3]	Function Key 3 Assignment	(Valid entries are 00-25)
[4]	Function Key 4 Assignment	(Valid entries are 00-25)
[5]	Function Key 5 Assignment	(Valid entries are 00-25)

Note: Each keypad must be individually programmed.

Entry	Description	Option	Description
[00]	Null Key: Program non functioning keys with this option	[15]	Not Used
[01]-[02]	Not Used	[16]	Quick Exit: See [16] [*][0] Quick Exit
[03]	Stay Arm: See [03] Stay Arm	[17]	Reactivate Stay/Away Zones: See [17] [*][1] Reactivate Stay/Away Zones
[04]	Away Arm: See [04] Away Arm	[18]	Not Used
[05]	No Entry Arm: See [05] [*][9] No Entry Arming	[19]	Command Output #3: See [19] [*][7][3] Command Output 3
[06]	Chime On/Off: See [06] [*][4] Door Chime On/Off	[20]	Night Arm
[07]	Not Used	[21]	Command Output #4: See [21] [*][7][4] Command Output 4
[08]	Bypass: See [*][1] on [08] Zone Bypassing	[22]-[24]	Not Used
[09]-[12]	Not Used	[25]	Instant Stay Arm: See [25] Instant Stay Arming
[13]	Command Output #1: See [13] [*][7][1] Command Output	[26]-[33]	Not Used
[14]	Command Output #2: See [14] [*][7][2] Smoke Detector Reset/Sensor Reset		

[072] Second User Display Mask

Opt	Def.	ON	OFF
1	✓	<input type="checkbox"/> User Initiated Call-up prompt ON	<input type="checkbox"/> User Initiated Call-up prompt OFF
2		<input type="checkbox"/> For Future Use	✓ <input type="checkbox"/>
3		<input type="checkbox"/> Walk Test prompt ON	✓ <input type="checkbox"/> Walk Test prompt OFF
4	✓	<input type="checkbox"/> Command Output #1 prompt ON	<input type="checkbox"/> Command Output #1 prompt OFF
5	✓	<input type="checkbox"/> Command Output #2 prompt ON	<input type="checkbox"/> Command Output #2 prompt OFF
6		<input type="checkbox"/> Command Output #3 prompt ON	✓ <input type="checkbox"/> Command Output #3 prompt OFF
7		<input type="checkbox"/> Command Output #4 prompt ON	✓ <input type="checkbox"/> Command Output #4 prompt OFF
8		<input type="checkbox"/> For Future Use	✓ <input type="checkbox"/>

[073] Downloaded LCD Message Duration

Default: 003 (Valid entries are 000-255, 000=Unlimited Message Display)

(This number represents the number of times the downloaded message is cleared by pressing any key while the message is up after time-out.)

[074] Key Options

Opt	Def.	ON	OFF
1	✓	<input type="checkbox"/> [F] Key Enabled	<input type="checkbox"/> [F] Key Disabled
2	✓	<input type="checkbox"/> [A] Key Enabled	<input type="checkbox"/> [A] Key Disabled
3	✓	<input type="checkbox"/> [P] Key Enabled	<input type="checkbox"/> [P] Key Disabled
4-8		<input type="checkbox"/> For Future Use	✓ <input type="checkbox"/>

[076] First Keypad Options

Opt	Def.	ON	OFF
1	✓	<input type="checkbox"/> Display Code when Programming	<input type="checkbox"/> Display Xs when Programming
2	✓	<input type="checkbox"/> Local Clock Display ON	<input type="checkbox"/> Local Clock Display OFF
3		<input type="checkbox"/> Local Clock Displays 24 Hr. Time	✓ <input type="checkbox"/> Local Clock Displays AM/PM
4	✓	<input type="checkbox"/> Auto Alarm Scroll ON	<input type="checkbox"/> Auto Alarm Scroll OFF
5		<input type="checkbox"/> Local Display of Temperature ON	✓ <input type="checkbox"/> Local Display of Temperature OFF
6	✓	<input type="checkbox"/> Bypass Options Prompt ON	<input type="checkbox"/> Bypass Options Prompt OFF
7		<input type="checkbox"/> For Future Use	✓ <input type="checkbox"/>
8		<input type="checkbox"/> Auto Scroll Open Zones ON	✓ <input type="checkbox"/> Auto Scroll Open Zones OFF

[077] Second Keypad Options

Opt	Def.	ON	OFF
1	✓	<input type="checkbox"/> Chime Enabled for Zone Openings	<input type="checkbox"/> Chime Disabled for Zone Openings
2	✓	<input type="checkbox"/> Chime Enabled for Zone Closings	<input type="checkbox"/> Chime Disabled for Zone Closings
3		<input type="checkbox"/> 5th Terminal is Keypad PGM Output	✓ <input type="checkbox"/> 5th Terminal is Keypad Zone Input
4	✓	<input type="checkbox"/> Language Select accessible from any menu	<input type="checkbox"/> Language Select from Installer Menu Only
5		<input type="checkbox"/> Power LED Enabled	✓ <input type="checkbox"/> Power LED Disabled
6	✓	<input type="checkbox"/> Power LED indicates AC Present ON	<input type="checkbox"/> Power LED indicates AC Absent ON
7	✓	<input type="checkbox"/> Alarms are always displayed while armed	<input type="checkbox"/> Alarms are not displayed while armed
8		<input type="checkbox"/> Low Temperature Warning Enabled	✓ <input type="checkbox"/> Low Temperature Warning Disabled

5.3 Programming Descriptions

Programming Descriptions

The following is a description of the programming features and options available in the control panel.

[000] Keypad Function Programming

Function Key	Description
[00] Null	The key is not used and will perform no function when pressed.
[01]-[02] Not Used	
[03] Stay Arm	Arms the partition to which the keypad is assigned. All stay/away and night type zones will be automatically bypassed. Delay type zones will provide entry and exit delay. The quick arm feature controls whether an access code must be entered after pressing this function key. The exit delay will be silent if the panel is armed using this function key.
[04] Away Arm	Arms the partition to which the keypad is assigned. All stay/away and night type zones will be active at the end of the exit delay. Delay type zones will provide entry and exit delay. The quick arm feature controls whether an access code must be entered after pressing this function key. The exit delay will be audible if the panel is armed using this function key.
[05] [*][9] No Entry Arming	After this function key is pressed, the user must enter a valid access code. The partition will arm and remove entry delay from the partition when the exit delay expires. The key can be pressed again to enable the entry delay. This function key always requires an access code entry after it has been pressed.
[06] [*][4] Door Chime On/Off	Pressing the key will toggle the door chime feature on or off. One solid beep means the feature has been disabled, three short beeps means it has been enabled.
[07] Not Used	
[08] Zone Bypassing	When this function key is pressed, the system enters the [*][1] Zone Bypassing menu. If desired, the panel can be configured to require an additional access code entry before the system enters zone bypassing
[09] Trouble Display	When this function key is pressed, the system enters the [*][2] Trouble Display menu.
[10] Not Used	
[11] User Code Programming	When this function key is pressed, the keypad prompts for an access code entry. If the master code or an access code with similar permissions is entered, the system enters the [*][5] User Code Programming menu.
[12] User Functions	When this function key is pressed, the keypad prompts for an access code entry. If the master code or an access code with similar permissions is entered, the system enters the [*][6] User Functions menu.
[13] [*][7][1] Command Output	This function key provides the user with a simple method of activating a PGM output programmed as Command Output 1. By default, an access code must be entered after the key is pressed before the output will activate, but this can be changed by disabling PGM attribute 5.
[14] [*][7][2] Smoke Detector Reset	Pressing this key will cause the panel to deactivate any output programmed as Sensor Reset.
[15] Not Used	
[16] [*][0] Quick Exit	Pressing this key will cause the panel to activate the Quick Exit feature.
[17] [*][1] Reactivate Stay/Away Zones	This function key provides the user with a simple method of adding stay/away zones into the system, and it changes the stay armed mode to away armed mode.
[18] Not Used	
[19] [*][7][3] Command Output 3	This function key provides the user with a simple method of activating PGMs programmed as Command Output #3. An access code may be required after pressing this key if PGM attribute 5 is enabled.
[20] Night Arming	The system arms with all Night Zones bypassed, even if the delay zones are violated during exit delay. This key only works while the system is disarmed, or armed in the stay mode. The panel logs Armed in Night Mode for this closing type. If no night zone types are programmed on the system, the panel will arm in away mode with an audible exit delay. Normally, no acknowledgement beeps are sounded and the exit delay is silent if this function key is used to arm. The quick arming toggle option controls whether an access code must be entered after the function key is pressed.
[21] [*][7][4] Command Output 4	This function key provides the user with a simple method of activating a PGM output programmed as Command Output 4.
[22]-[24] Not Used	

[25] Instant Stay Arming	This function key was formerly used for Recall Bypass Group 2. This feature operates similarly to the stay arming function key except for the following: When this function key is pressed, no acknowledgement beeps are sounded, there is no exit delay; and the system arms immediately. The panel logs "Armed in Stay Mode" for this closing type. If no stay/away zone types are programmed, the system arms in Away mode with no exit delay. Note: This function key must not be used in CP-01 listed systems.
[26]-[33] Not Used	Not Used.

Zone Programming

Zones 1-8 are enabled by default. Disable unused zones or enable additional zones in Section [001] Zone 1–8 Definitions. The zone definitions describe how each of the zones you use will operate. Program a two-digit code describing the zone definition. Select a definition from the list below.

In addition, each zone has 16 different attributes which may be programmed in Sections [101]-[108] Zone Attributes. (See also programming descriptions Section [101]-[108] Zone Attributes)

[001] Zone Definitions

[00] Null Zone

This zone type should be programmed if an input is not going to be used. Programming this zone type should clear any trouble conditions present on the zone input. An EOL resistor is not required for this zone definition.

[01] Delay 1

This zone type, normally used for entry/exit doors, can be violated and restored during the exit delay time without causing an alarm. After the exit delay has expired and the system is armed, violating this zone shall start the entry delay 1 timer. During the entry delay time, the keypad buzzer will sound steadily to advise the user that the system should be disarmed. If the panel is disarmed before the entry time expires, no alarm will be generated.

[02] Delay 2 Zone

This zone type operates the similar to the delay 1 zone; however, it follows a different entry delay timer, defined as Entry Delay 2 in Section [005] System Times. Typically this zone type is used for garage doors or for entry/exit points that require a different delay time than what is being used for the main entry/exit point. The Delay 2 entry delay time can be set independently of Delay 1 in programming Section [005] (System Times).

[03] Instant Zone

This zone type causes an instant alarm if it is violated when the panel is armed; it does not provide an entry delay when violated while armed. This zone type does not generate an alarm when disarmed. Typically, this zone is used for windows, patio doors or other perimeter zones, and glass break detectors.

[04] Interior Zone

Interior zones have an exit delay and an entry delay if a delay zone has been violated first. The zone goes into alarm when the entry delay of the delay type zone has expired if the system has not been disarmed. If the zone is violated without an entry or exit delay being active on the system, an immediate alarm is generated. This zone will not cause an alarm if violated during the entry delay. If the zone is violated before the entry delay has begun, it will cause an instant alarm. Typically, this zone is used for interior protection devices, such as motion detectors.

[05] Interior Stay/Away Zone

If the system is stay armed, this zone is bypassed. If the system is armed in away or night mode, the zone acts like an Interior Zone type [04].

[06] Delay Stay/Away Zone

If the system is stay armed, this zone is bypassed. If the system is armed in away or night mode, this zone acts like a Delay 1 type [01].

[07] Delayed 24-hr Fire Zone

Note: Do not wire Fire zones on keypad zone terminals if the DEOL supervision option is enabled for the panel (Section [013], Option [2]).

This zone type requires a SEOL resistor, and it cannot be reconfigured using the NC, EOL or DEOL options in the panel. The alarm state is short, the restored state is 5k6, and an open condition will generate a zone tamper and fire trouble. When this zone is violated, the alarm output will be immediately activated (pre-alert) but the communicator will be delayed for 30 seconds. If the alarm is acknowledged by pressing any key during this delay or by tripping a keyswitch zone, the alarm output and the communicator will be delayed an additional 90 seconds, giving the user time to correct the problem. If the zone is still violated after the 90 second delay, the sequence will repeat.

If the user does not press a key during the 30 second pre-alert, the alarm output will latch and the panel will communicate the alarm to the central station. The alarm will sound until the Bell Cutoff time expires ([005] System Times) or until a code is entered.

Note: If a second Fire type zone is violated or if the Fire keys are pressed during the delay period, the panel will latch the alarm output and will immediately communicate the alarm.

A violated Fire zone will be displayed on all keypads and can be delayed at any keypad. Typically this zone is used for latching smoke detectors.

[08] Standard 24-hr Fire Zone (hardwired)

Note: Do not wire Fire zones on keypad zone terminals if the DEOL supervision option is enabled for the panel (Section [013], Option [2]).

This zone type requires a SEOL resistor, and it cannot be reconfigured using the NC, EOL or DEOL options in the panel. The alarm state is short, the restored state is 5k6, and an open condition will generate a zone tamper and fire trouble. When violated, the bell output will sound a pulsing alarm tone to indicate that the fire loop has been activated. If enabled, the communicator will immediately send an alarm to the central station. The alarm will sound until the Bell Cutoff time expires (Section [005] "System Times"), or until a code is entered. A violated Fire zone will be displayed on all keypads. Typically this zone is used for pull stations.

[09] 24-hr Supervisory Zone

This zone type requires a SEOL resistor, and it cannot be reconfigured using the NC, EOL or DEOL options in the panel. The restored state of this zone is 5.6k, the alarm state is short and the tamper state is open. This zone type should not be used with wireless zones. This zone does not cause the bell to activate, but will be displayed in alarm memory regardless of the armed state of the panel. If this zone is violated when the system is either armed or disarmed, the panel will report to the central station, and will log the zone alarm to the event buffer. This zone gives a silent alarm by default.

Note: Do not wire 24-hr Supervisory zones on keypad zone terminals.

[10] 24-hr Supervisory Buzzer Zone

If this zone is violated when the system is either armed or disarmed, the panel will immediately latch the keypad buzzer until a valid access code is entered and will immediately communicate to the central station.

[11] 24-hr Burglary Zone

If this zone is violated when the system is either armed or disarmed, the panel will immediately latch the alarm output and communicate to the central station. The alarm will sound until the Bell Cutoff time expires (Section [005] "System Times"), or until a code is entered.

[12] Not Used**[13] 24 Hr. Gas**

This zone type is active at all times, regardless of the armed state, and when tripped will generate an audible, pulsing alarm. This zone type is typically used with CO detectors or for monitoring gas lines.

[14] 24 Hr. Heat

This zone type is active at all times, regardless of the armed state, and when tripped will generate an audible, steady alarm. This zone type is typically used with heat detectors.

[15] 24 Hr. Medical

This zone type is active at all times, regardless of the armed state, and when tripped will generate an audible, steady alarm. This zone type is typically used for medical emergency pull stations.

[16] 24 Hr. Panic

This zone type is active at all times, regardless of the armed state, and when tripped will generate an audible, steady alarm. This zone type is typically used with panic pendants.

[17] 24 Hr. Emergency

This zone type is active at all times, regardless of the armed state, and when tripped will generate an audible, steady alarm. This zone type is typically used for non-medical emergency situations.

[18] Not Used**[19] 24 Hr. Water**

This zone type is active at all times, regardless of the armed state, and when tripped will generate an audible, steady alarm. This zone type is typically used for monitoring flood conditions.

[20] 24 Hr. Freeze

This zone type is active at all times, regardless of the armed state, and when tripped will generate an audible, steady alarm. This zone type is typically used in applications that monitor low temperatures.

[21] 24-hr Latching Tamper

This zone type, when violated, will cause arming of the system to be inhibited until the installer accesses Installer Programming or the condition has been reset using DLS. This zone type is normally used for monitoring the panel's cabinet. If the cabinet has been opened, someone may have tampered with the system's wiring, so this zone type is used to generate an installer service call. This zone type generates an audible, steady alarm in both armed and disarmed states.

[22] Momentary Keyswitch Arm Zone

A keyswitch device (mechanical switch controlled by a key) may be connected to the zone input programmed as momentary keyswitch. Momentary activation (open and close) of the zone alternately arms/disarms the system and silences alarms. Tamper and faults will only initiate their respective trouble sequence. The keypad will not display an indication when this type of zone is activated. When an audible alarm is active, using the keyswitch when disarmed is the same as entering an access code at the keypad. The system will log special closing or special opening if the keyswitch is used for arming/disarming. If a keyswitch device is bypassed, the bypass must be manually removed.

[23] Maintained Keyswitch Arm Zone (Hardwired)

A keyswitch device (mechanical switch controlled by a key) may be connected to the zone input programmed as maintained keyswitch. In the restored state, the system is disarmed. In the violated state, the panel will arm. Tamper and faults will only initiate their respective trouble sequence. The keypad will not display an indication when this type of zone is activated. If the system is armed using this zone (violated), but the system is disarmed using a different method, the keyswitch must be restored and violated again to start a new arming sequence. The same is true for disarming.

A bypass of this zone type must be manually removed.

With an audible alarm active, using the keyswitch when disarmed is the same as entering an access code at the keypad. Activating this zone type during the first 30 seconds of a delayed fire alarm is the same as entering an access code at the keypad (the 90 second delay will start). If left in the violated state, the system will not arm until the zone is restored and violated again.

[24] Not Used

[25] Interior Delay Zone

This zone type is normally used with interior motion detectors and has a standard exit delay time. If the panel is armed in away or night mode, the interior delay zone will be active at the end of exit delay. The zone then acts like an Interior zone [04]. If the system is armed in stay mode, the zone behaves like a delay 1 zone. Violating this zone during exit delay will not cause the system to arm in away mode like regular delay 1 zones do.

[26] 24 Hour Non-Alarm (or local alarm) Zone

Zones programmed as this type are active at all times but do not cause an alarm, and are not saved in alarm memory. Zone attributes such as Zone Bypassing and Door Chime affect the functionality of this zone. Typically, this zone type is used in conjunction with a zone follower PGM to trigger an output when violated but not cause alarm conditions.

Note: This zone type sounds the bell but does not communicate during a walk test. Tamperers and faults on zones programmed as 24-Hour non-alarm type do not cause alarms.

[27]-[30] Not Used

[31] Day Zone

Violating this zone when disarmed sounds the keypad buzzer but does not log or report the events. Violating this zone when armed sounds the bell and communicates the event.

[32] Instant, Stay-Away Zone

This zone is bypassed when the system is Stay armed or disarmed, but it functions similarly to an Instant Zone [03] when Away or Night armed. This zone type is useful for motion detectors that must NOT follow the entry delay after a delay zone is violated, but must still retain the Stay/Away functionality.

[33]-[34] Not Used

[35] 24-Hr. Bell/Buzzer

This zone type will behave like a 24 hour burglary zone when armed and a 24 hour buzzer zone while disarmed. When the panel is armed, the siren will activate for the duration of bell time out when this zone is violated. When the panel is disarmed, the keypad buzzers will latch until a valid disarming procedure is used.

[36] 24-Hr. Non-Latching Tamper

This zone type is always active and will report a tamper condition if the panel is armed or disarmed. The communications generated for this zone type do not follow transmission delay. In DEOL configuration, a tamper or open condition will generate a tamper event. A short condition will generate a fault event.

[37] Night Zone

This zone type is bypassed if the panel is disarmed, armed in stay mode or armed in night mode. It is active in the armed state and behaves like an Interior zone. If entry delay is active, the zone type will not create an alarm until the entry delay expires. If violated while away armed, but entry delay isn't active, the zone will generate an instant alarm.

[41] 24-Hr. CO Zone (hardwired)

This zone definition is only to be used with hardwired carbon monoxide detectors. The zone is active in all armed states. This zone definition has its own bell cadence. The siren shall sound 4 cycles of 100mS On/Off pulses, followed by a 5 second pause and then the sequence repeats. After four minutes, the 5 second pause will be extended to a 60 second pause. The bell will be silenced upon bell time out or when a code has been entered at the keypad. No bell delay or transmission delay will affect this operation. Tamperers and faults from a CO zone type will not impede arming.

If a CO zone is in Device Fault, the control panel will sound CO cadence. This is different when compared to a low sensitivity fault in a smoke detector, which will not generate an alarm.

A tamper restore must be created on the device to remove any device faults, which will prevent run-away transmission from a device going in and out of fault.

[81]-[88] Not Used

[005] System Times

Enter Section [005] then Subsection [01] to program the **Entry Delay 1**, **Entry Delay 2** and **Exit Delay** for the system. Entries are in seconds. A value of 000 in the entry or exit delay sections causes a 255 second delay; however, the time is displayed as 000. Enter Section [005] then Subsection [09] to program the **Bell Cut-Off Time**. Valid entries are in minutes. A value of 000 in the BTO section produces a 1 minute bell cut-off time. However, this time is displayed as 000.

[006] Installer Code

The default Installer Code is [5555] or [555555] if 6-Digit Access Codes is enabled.

[007] Master Code

Only programmable through DLS. The default code is [123456].

[008] Maintenance Code

The Maintenance Code is a system user code that can only arm and disarm. Any other system function that requires an access code is not accessible by this code. The default Maintenance code is [AAAA] or [AAAAAA] if 6-digit access codes are programmed. See [701] First International Options Opt. 5.

[009]–[011] PGM Programming (Zones/PGMs)

Program the programmable outputs PGM 1 and PGM 2 on the main board and on PC5208 and PC5204 by selecting one of the output options listed below (exceptions noted)].

PGM Output Options

- 01 **Burglary and Fire Bell Output.** This output will activate when the siren output is active and will turn off when the alarm output deactivates. If the siren is sounding a pulsing alarm, the PGM output will pulse as well. This PGM will follow:
 - Fire alarm pre-alert
 - Temporal three fire signal (if enabled)
 - All burglary and fire alarms
 - Bell cut-off time
 This output does will **NOT** activate for siren squawk events of any type.

i Fire alarms take precedence over burglary. Therefore, if the PGM is indicating a steady burglary alarm, and a fire alarm occurs, the PGM will follow a pulsing cadence. If the PGM is already on when a silent alarm occurs, the output will remain on.

- 02 Not Used
- 03 **Sensor Reset.** This output is normally active (switched to ground). This option is used to remove and restore power for latching smoke detectors. The output will deactivate for 5 seconds when the [*][7][2] command is entered (refer to [*][7] command outputs). When this PGM is programmed, the PGM output is normally low, which is the opposite of how most PGMs operate at default. This is because the PGM is used as the negative return for power to 4-wire smoke detectors (positive comes from the Aux + terminal). To activate this output and reset smoke detectors, [*][7][2] must be entered at the keypad or an equivalent function key must be used. The PGM terminal will go high (open circuit) and thus remove power from the devices connected.
- 04 **2-Wire Smoke.** When this PGM is programmed, the onboard PGM 2 functions as an input instead of an output. It behaves much like the sensor reset PGM in that it is normally low supplying the negative return. Two-wire smoke devices can be connected to this input. The PGM is also supervised, and a trouble condition is generated if a 2.2K resistor is not present between the PGM terminal and AUX+. The two-wire smoke detector input creates an instant and latching alarm.
- 05 **System Armed Status.** This output will activate (switch to ground) when the system is armed and will deactivate when disarmed. Depending on the market, the panel may turn off this PGM when keypad blanking is active.
- 06 **Ready to Arm.** The PGM switches to ground when the system is ready to arm (all non-force armable zones on the system are restored). When an access code is entered to arm the system and the exit delay begins, the PGM output is de-activated. This PGM operates as described during walk test mode (if all zones are restored).
- 07 **Keypad Buzzer Follow.** The PGM output switches to ground when the keypad buzzer is activated by the events described below:
 - 24-hour supervisory buzzer zone alarm
 - Entry delay
 - Door chime
 - Auto-Arm or No activity arm pre-alert
 - Audible exit delay
 The PGM output remains switched to ground while the keypad buzzer is active. This PGM type does not activate for local key presses or trouble beeps.
- 08 **Courtesy Pulse.** This PGM output switches to ground for 2 minutes past the end of entry or exit times to allow enough time for complete entry to or exit from the premises. This option can also be used to turn on a light along the entry/exit route during the entry or exit delay times. If the system is armed through the *No Activity Arming* method this output will NOT activate.

PGM Output Options

- 09 **System Trouble.** This PGM output switches to ground when any of the selected Troubles are detected. The output de-activates when all of the selected Troubles are restored. The PGM attributes for this output are unique for this PGM type and the standard attributes do not apply. The PGM attributes for this output are as follows:

- | | |
|---|---------------------------|
| 1 Service Required* | 5 Fire Trouble/Zone Fault |
| 2 A.C. Failure | 6 Zone Tamper |
| 3 Telephone Line Fault | 7 Zone Low Battery |
| 4 Communications (Failure to Communicate) | 8 Loss of Clock |

Note: * = Battery, Bell circuit, General System Trouble, General System Tamper, General System Supervisory Troubles, PC5204 Low Battery and PC5204 AC Fail

- 10 **System Event Output.** This PGM output switches to ground when any of the selected system events (alarms) occur on the system. In the armed state, the output will deactivate only once the system is disarmed.

If an alarm causes this output to activate in the disarmed state, the output will deactivate if a user enters a valid access code while the bell is still active. If BTO has occurred, the PGM will deactivate if someone arms the system after the bell cut-off has expired. This output can be used to indicate that an alarm has occurred before entering the premises. The PGM attributes for this output are unique and the standard attributes do not apply. Program the events that will activate the output by selecting some or all of the following PGM attributes:

- | | |
|---------------|---|
| 1 Burglary | Delay, Instant, Interior, Stay/Away and 24-Hour Burg. zones |
| 2 Fire | <input type="checkbox"/> Key, Fire zone |
| 3 Panic | <input type="checkbox"/> Key and Panic zone |
| 4 Medical | Auxiliary Key, Medical and Emergency zones |
| 5 Supervisory | Supervisory, Freezer and Water zones |
| 6 Priority | Gas, Heat, Sprinkler and 24-Hour Latching zones |
| 7 Not Used | |
| 8 Latched | Output Follows Pulse timer/Output Latching |

i

Note: This PGM output activates for alarm conditions only. Pre-alerts or delays do NOT activate the output. When this output follows the output timer, events that have been disabled from activating the output do not restart the timer.

- 11 **System Tamper.** This PGM output switches to ground when any Tamper condition occurs on the system and deactivates when all Tamper conditions on the system are cleared. These tampers include zone tampers (DEOL), 24 Hr Latching or Non-latching Tamper Zones, module tampers and keypad tampers. This output will also activate for the following events): Bell Circuit Trouble, TLM Trouble, Keybus Fault, Zone Expander Supervisory, General System Supervisory, and General System Tamper.
- 12 **TLM and Alarm.** The output activates when a Telephone Line Trouble (TLM) condition is present followed by an alarm condition. The output will remain active until an access code is entered to disarm the partition. The output will activate for all audible and silent alarms except for duress if a TLM trouble is present at the time of the alarm. If an alarm activates this output in the disarmed state, it will deactivate when the system is armed or the telephone line trouble is restored.
- 13 **Kiss-off.** This output will activate (switch to ground) for two seconds after the panel receives the kiss-off signal from the central station receiver.
- 14 **Ground Start.** This PGM output is used for old telephone systems where Tip and Ring need to be shorted together briefly to get dial tone. The output will activate for two seconds before the panel attempts dialing to obtain a dial tone on Ground Start telephone equipment. Two 2-second pauses (hex E) must be inserted at the beginning of the telephone number when using this option.
- 15 **Remote Operation.** This output can be activated or deactivated remotely by using DSC's Downloading Software.
- 16 Not Used
- 17 **Away Armed Status.** This output will activate at the beginning of exit delay when the system is armed using away mode. Some markets, like Europe and France, require that this PGM activate at the end of exit delay which is when the panel is technically armed.
- 18 **Stay Armed Status.** This output will activate when the system is armed with the stay/away zones bypassed. PGM output types [17] and [18] are designed to follow the status of the stay/away zones. If the system is armed with stay/away zones bypassed, the stay output should be active. If the system is armed with the stay/away zones active, the AWAY armed status PGM will turn on. The following indicates how these arming techniques work:
- | | |
|-------------------------|--|
| STAY key | Stay |
| [*][9] + Code | Stay |
| AWAY key | Away |
| Keyswitch Arm | Depends on delay type zone during exit delay |
| [*][0] Quick Arm | Depends on delay type zone during exit delay |
| Access Code Arm | Depends on delay type zone during exit delay |
| DLS Arm | Away |
| Auto Arm | Away |
| Stay Armed, then [*][1] | Away |

PGM Output Options

- 19 **Command Output #1.** This output is activated by entering the [*][7][1] command. The configuration of the corresponding attributes determines how this PGM will activate. Command outputs 1-4 are user initiated by entering [*][7][1-4] at any keypad. When any output is activated, three ack beeps will be sounded by the keypad. This feature is User controlled. This function can be performed when a Programmable Output is programmed as Type [19].
This output can be used for operating devices such as garage door opener, special lighting or door strikes.
Note: If there are multiple outputs programmed with the same PGM type, the PGM attributes must be the same for each of them.
- 20 **Command Output #2.** This output is activated by entering the [*][7][2] command. The configuration of the corresponding attributes determines how this PGM will activate. Only one sensor reset or command output #2 PGM can be programmed on the system. This feature is User controlled. This function can be performed when a Programmable Output is programmed as Type [03] or Type [20], but not both.
This output can be used to reset all smoke detectors on the system (2-Wire and 4-Wire).
- 21 **Command Output #3.** This output is activated by entering the [*][7][3] command. The configuration of the corresponding attributes determines how this PGM will activate. This feature is User controlled. This function can be performed when a Programmable Output is programmed as Type [21].
This output can be used for operating devices such as garage door opener, special lighting or door strikes.
- 22 **Command Output #4.** This output is activated by entering the [*][7][4] command. The configuration of the corresponding attributes determines how this PGM will activate. This feature is User controlled. This function can be performed when a Programmable Output is programmed as Type [22].
This output can be used for operating devices such as garage door opener, special lighting or door strikes.
- 23-24 Not Used
- 25 **Delayed Fire and Burg Output.** This programmable output type operates the same as the fire and burglary output (PGM type 01), except that it follows the transmission delay timer programmed in Section [377]. If a zone is violated that has the transmission delay attribute enabled (bit 7), the Bell and Regular Fire and Burg PGMs will activate. At the end of the transmission delay, the delayed fire and burg output will activate. This PGM is usually used to control outdoor sirens: if a "false" alarm occurs on the panel, the user has the duration of transmission delay to disarm the system before the external sirens activate.
Note: If a zone is violated that causes an alarm, but does not follow transmission delay, this PGM will activate immediately, even if transmission delay is active for a different zone alarm.
Note: This PGM, if programmed, shall not interfere with the operation of any other programmable output.
Note: This output activates for audible exit fault.
- 26 Not Used
- 27 **Police Code Output.** When the police code event occurs, this output will activate until the panel is either armed or disarmed. If police code is not configured to communicate, the PGM will still activate for the event.
- 29 **Zone Follower 1-8.** This output type is normally active and allows an output to deactivate for the duration that a zone is violated. The PGM attributes are programmed through an 8 bit toggle mask that selects which zones the output will follow. The toggle mask is programmable in Sections [551-564]. Example: If PGM is programmed as Type 29 with extended attributes 1, 6 and 8 ON, the output will turn off when any of the three zones are violated, and will restore when all three zones are restored.
- 30 **Status Alarm Memory Output.** This feature is intended to be used on a keyswitch plate, with a light controlled by this PGM to indicate system status. The status alarm memory output will activate (steady) at the beginning of exit delay, when the partition is armed. If an alarm occurs on the armed partition, the output will flash (1 sec ON/1 sec OFF) for the remainder of the armed period. If an alarm occurs on a disarmed partition (24 Hr Zone), the output will flash (1 sec ON/1 sec OFF) until the alarm is acknowledged (bells are silenced during BTO, or the partition is armed after BTO). This output will not activate in walk test.

[012] Keypad Lockout Options

This section determines how the keypad function operates. The panel can be configured to "lockout" keypads if a series of incorrect access code entries are made.

Number of Invalid Codes Before Lockout

Program a number from 001 to 255 to determine the number of invalid master, user or installer access code entries to reach keypad lockout. When keypad lockout occurs, the system is rendered inoperative via the keypad for the programmed duration only (wireless keys and keyswitch zones still function). When any keys are pressed, an error tone sounds. Entering 000 disables keypad lockout.

Lockout Duration

Program a time from 001 to 255 minutes to determine the length of time before lockout resets and the keypad can once again be used.

- If lockout is not reached within the hour roll-over (01:59 to 02:00 for example), the number of invalid attempts is reset to 0.
- After a valid access code is entered, the number of invalid attempts is reset to 0.
- Fire, Auxiliary and Panic keys are still active during keypad lockout.
- Key presses do not reset the timer.
- If the lockout timer was active before powering down, the system lockout is active for the programmed duration on power up.

[013] First System Options





Option	Description
[1] Zone Loop Type	ON: Normally Closed Loops. All zones are wired as normally closed circuits with returns connected to a COM terminal. The end-of-line resistor is not required. An alarm will be generated when the circuit is opened. OFF: End-of-Line Resistors. All zones must be wired with an end-of-line resistor configuration, determined by Option 2 in Section [013].
[2] End-of-Line Option	ON: Double End-of-Line Resistors. All zones will use Double End-of-Line resistors, except Standard Fire, Delayed Fire and 24 Hr Supervisory. These zones must be connected using the EOL resistor. Double EOL resistors enable the detection of zone faults and tampers. The tamper resistor (5k6) is placed across the alarm activating device, and the single EOL resistor (5k6) is placed between the alarm and tamper contacts. This configuration will allow the panel to detect zone faults (zone shorted), zone tampers (open zone), zone alarms (11.2k) and restored zones (5k6). If the zone/system is disarmed and placed in the tamper or fault state, trouble beeps will be generated on all system keypads until a key is pressed. If the zone is armed and a tamper is activated, the tamper alarm and zone alarm will be logged and transmitted. The zone will begin the normal alarm sequence (bells, alarms in memory, etc.). OFF: Single End-of-Line Resistors. All zones must have a 5k6 resistor across the terminals. If the zone is shorted or opened, it will be treated as a violated state. If the zone is open and programmed as a fire zone, it will be in the trouble state.
[3] Trouble Display	ON: Panel Shows All Troubles While Armed. The panel will activate the trouble LED in both the armed and disarmed state when any trouble is present on the system. OFF: Panel Shows Fire Troubles While Armed. The panel will activate the trouble LED for all troubles while disarmed, but the LED will only activate for Fire Troubles while the system is armed.
[4] Tamper/Fault Display	ON: Tampers and Faults Do Not Show As Open. The panel will not activate the respective Zone LED if the zone is in the tamper or fault states, only the Trouble LED will be on. OFF: Tampers and Faults Show as Open. The panel will illuminate the respective Zone LED (LED Keypads) if the zone is in the tamper or fault state.
[5] Auto-Arm Schedule	ON: Auto-Arm Schedule in [*][6]. The auto-arm schedules (Section [181]) are accessible via [*][6] as well as Installer Programming. OFF: Auto-Arm Schedule in Installer Programming Only. The auto-arm schedules (Section [181]) are only accessible via Installer Programming.
[6] Audible Exit Fault	ON: Audible Exit Fault is Enabled. If a delay type zone is violated or is still violated within 4 seconds after the exit delay has expired, the panel will sound the entry delay warning through the keypad and siren alerting the customer that an improper exit was made. If the panel is disarmed within the entry delay, no signal is sent. If not, the panel will continue to sound the alarm and send a signal to central station. Audible Exit Fault Pre-Alert will be logged when the entry delay begins, and audible exit fault will be logged and communicated when the exit delay expires. OFF: Audible Exit Fault is Disabled. The siren will not activate during the entry delay created by leaving a delay zone violated when exit delay expires.
[7] Zone Doubling	ON: Zone Doubling Enabled. When the Zone Doubler option is enabled on a PC1404, Zone 1 will become Zones 1 and 5, Zone 2 will become Zones 2 and 6, and so on, up to 8 hardwired zones. The 4 zones on the main board now act as 8 zone inputs. When enabled, Options 1 and 2 in Section 013 are ignored. Wireless and Keypad Zones should not be used on zones designated for Zone Doubling (PC1404: Zones 1-8) Fast Loop Response Feature (Section 030) will not work when Zone Doubling is enabled. OFF: Zone Doubling is Disabled. The 4 zones on the main board act as 4 zone inputs.
[8] Fire Signaling	ON: Temporal 3 Fire Signal. To comply with NFPA 72, all Fire Bells will sound the temporal 3 fire cadence as described in the NFPA standard if this option is enabled. The cadence is 500ms ON, 500ms OFF, 500ms ON, 500ms OFF, 1.5 sec OFF. OFF: Standard Pulsing Fire Signal. All fire bells will sound with the standard 1 second ON/1 second OFF fire bell cadence.

[014] Second System Options

Option	Description
[1] Bell Squawk	ON: Arm/Disarm Bell Squawk Enabled. The system squawks the bell output once when armed (including auto-arming) and twice when disarmed. If there are alarms in memory, 3 distinct squawk pairs will sound (6 squawks in total). Note: Non-NA panels must squawk the bell at the end of exit delay. NA panels squawk at the beginning of exit delay. OFF: Arm/Disarm Bell Squawk Disabled. Bell output does not activate when the system is armed or disarmed in any manner.
[2] Bell Squawk for Auto-Arming	ON: Bell Squawk For Auto-Arming Enabled. The bell output will sound a single squawk every 10 seconds during the auto-arm pre-alert time. This also applies to no activity arming pre-alerts. OFF: Bell Squawk For Auto-Arming Disabled. The bell output will not be activated during auto arming or no activity arming pre-alerts.
[3]-[6]	Future Use

- [7] **Exit Delay Termination Enabled.** The exit delay will be reduced to 5 seconds when the system detects that a delay 1 zone has been restored during exit delay. All audible indications associated with the exit delay (keypad tones, bell squawks) will be silenced when the exit delay is reduced and terminates. Force armable delay 1 zones will still cause the exit delay to be reduced if they restore during the exit period.
Exit Delay Termination Disabled. The exit delay timer will continue to count down even after the delay zone for the entry/exit door or area is restored.
- [8] **ON: Fire Bell is Continuous.** The bell output will sound for all fire type alarms until a valid disarming procedure is entered to silence the alarm or disarm the system, regardless of the time programmed for bell timeout in Section [005].
OFF: Fire Bell Follows Timeout. The bell output will sound for all fire type alarms for the duration of bell timeout or until an access code is entered.

[015] Third System Options

- | Option | Description |
|----------------------------------|---|
| [1]
[F] Key
Annunciation | ON: Fire Key Enabled. Pressing and holding the fire  key for 2 seconds generates a fire alarm. The keypad sounds a set of 3 beeps to acknowledge the valid alarm and the bell activates and sounds the fire cadence. Communication of the alarm to the central station is immediate. The bell sounds for the length of the bell time-out unless Fire Bell is Continuous is enabled.
OFF: Fire Key Disabled. The Fire  key does not sound or report an alarm when pressed.
Note: When enabled, this key generates alarms at all times, regardless of what is happening on the system, unless the panel is in Installer Programming. |
| [2]
[P] Key
Annunciation | ON: Panic Key Audible. When a valid Panic key  alarm is generated, the keypad buzzer sounds a series of 3 beeps to acknowledge the alarm. The bell or siren will also sound for the duration of BTO.
OFF: Panic Key Silent. When a valid Panic key  alarm is generated, the keypad buzzer and the bell output remain silent, but the alarm reporting code is still transmitted to the central station (if programmed). |
| [3]
Quick Exit | ON: Quick Exit Enabled. When the system is armed, users may enter the [*][0] command to allow a single delay 1 or delay 2 zone to be activated and restored so they can leave the premises without disarming the system. Only one delay zone may be activated; a second zone trip will initiate its respective alarm sequence. If the delay zone is still open two minutes after the [*][0] command is entered, the entry delay will begin. If armed in stay mode, the automatic bypass of the stay/away zones will not be removed.
OFF: Quick Exit Disabled. When the system is armed, users cannot perform a quick exit by pressing [*][0]. |
| [4]
Quick Arming | ON: Quick Arming Enabled/Function Keys Do Not Require Code. [*][0] arming and Stay/Away function keys may be used to arm the system without the entry of a valid access code. All other function keys may also be used without the entry of an access code.
OFF: Quick Arming Disabled/Function Keys Require Code. [*][0] arming is not permitted, and all function keys (including Stay/Away) require the entry of an access code to arm the system. |
| [5]
Bypass Access Code | ON: Code Required for Bypassing. After entering the [*][1] Bypass Zones command, an access code must be entered before zones may be bypassed.
OFF: No Code Required. The user can enter [*][1] and gain access to zone bypassing without the use of an access code. |
| [6]
Master Code | ON: Master Code Not Changeable. The Master Code (access code 40) may not be changed by the user with [*][5] access code programming. The Master Code can only be programmed in Installer Programming, Section [007].
OFF: Master Code Changeable. The Master Code (access code 40) may only be programmed by the user in Installer Programming. |
| [7]
Telephone Line Monitoring | ON: TLM Enabled. The Telephone Line Monitor function is active and the system indicates if a Telephone Line Trouble condition exists when using the [*][2] View Trouble Conditions command.
OFF: TLM disabled. The Telephone Line Monitor function is shut off and telephone line troubles are NOT indicated by the system. |
| [8] | For Future Use |

[016] Fourth System Options

- | Option | Description |
|---------------------------|---|
| [1]
AC Trouble Display | ON: AC Trouble Displayed. If AC power fails, the condition will be reported to the monitoring station and will be indicated as a trouble condition on the system's keypads.
OFF: AC Trouble Not Displayed. If AC power fails, the condition will be reported, but the trouble LED will not be activated on the system's keypads. If [*][2] is entered to view the system troubles, Trouble #2 will still be displayed. |
| [2]
AC Trouble Flash | ON: Trouble Light Flashes if AC Fails. When AC power is lost from the system, the Trouble LED will flash in the base Ready and Armed modes within 30 seconds of the AC loss. When AC restores, the Trouble LED will stop flashing within 30 seconds.
OFF: Trouble Light Does Not Flash if AC Fails. When AC power is lost, the trouble LED will not flash but instead will turn on steady, depending on the programming of [016] Option 1. |

- [3] **Keypad Blanking** **ON: Blank Keypad When Not Used.** If no keys are pressed for 30 seconds, the display and all keypad lights except backlighting (if enabled) turn **OFF** until the next keypress, entry delay, audible alarm, or keypad buzzer condition. Keypad function and FAP keys still operate during keypad blanking.
OFF: Keypad Always Active. The keypad lights remain **ON** at all times.
- [4] **Keypad Blanking Restore Options** **ON: Access Code required to remove Keypad Blanking.** A valid access code must be entered before blanking can be removed.
OFF: Access Code Not Required. Pressing any key on a blanked keypad removes the blanking.
- [5] **Keypad Backlighting** **ON: Keypad Backlighting Enabled.** All keypads on the system have backlighting on at all times.
OFF: Keypad Backlighting Disabled. Keypad backlighting is always off.
- [6] **Power save mode** **ON: Power Save Mode Enabled.** If AC Power fails, all keypad lights, including backlighting, will be shut off. The keypad lights will come back **ON** after a keypress, entry delay, audible alarm or keypad buzzer condition (except door chime). The keypad lights will return to the off state after 30 seconds of no activity. If the AC Fail condition restores, the keypad lights will be reactivated.
OFF: Power Save Mode Disabled. If AC Power fails, the keypads will not go into power save mode.
- [7] **Bypass Status Display** **ON: Bypass Status Displayed While Armed.** The bypass light will be **ON** if there are zones bypassed when the system is armed.
OFF: Bypass Status Not Displayed While Armed. The bypass light will be **ON** only while the system is disarmed to indicate that there are bypassed zones on the system. When the system is armed, the bypass light will be **OFF**.
Note: The bypass status LED will be **ON** if there are Stay/Away zones auto-bypassed at the time of arming, regardless of whether or not this option is enabled. This option only enables and disables manual bypass display.
- [8] **Keypad Tamper** **ON: Keypad Tamper are Enabled.** All keypads containing Tamper switches will generate tamper alarms and Restores.
OFF: Keypad Tamper are Disabled. The tamper switches on all keypads will not generate tamper alarms.
Note: If this option is used, all keypads should be properly installed and secured (tamper restored) before enabling the option. Alternatively, the panel can be powered down/up after enabling this option to ensure all the tampers are detected.

[017] Fifth System Options

Option	Description
[1]-[3]	Future Use
[4]	ON: Double Hit Enabled. Two alarms from the same zone within the Cross Zone Timer Duration will cause the Police Code or Cross Zoning events to be logged and transmitted. OFF: Double Hit Disabled. Two alarms from the same zone will not cause the Police Code or Cross Zoning events to be logged and transmitted. Two different zones must be in alarm to transmit the Police Code or verify the Cross Zone.
i	This feature only applies to zones defined as Interior, Interior Delay, Interior Stay/Away, Instant Stay/Away, Delay Stay/Away, or Night Zones (PIR Zones).
[5]	ON: Late to Close Enabled. The panel will log and communicate a late-to-close event at the time programmed for auto-arm. This system toggle controls whether the late-to-close reporting code is sent at the end of the auto-arming pre-alert. This feature is used in installations that require an audible warning that the panel should be armed at a specific time of day, but are not required to auto-arm. OFF: Late to Close Disabled. The panel will not communicate or log late to close for any reason. Note: If the auto-arm toggle option is disabled, the auto-arm pre-alert will still occur if there is a time programmed for that day and this option is ON . This option does not directly affect the operation of auto-arm. If late to close is enabled, and auto-arming is not, LCD keypads will still display "System arming in progress" during the late to close pre-alert.
[6]	ON: Daylight Savings Time Enabled. The panel will adjust between daylight and standard times according to the programmed month, day, year, week and hours in Sections [168] and [169]. OFF: Daylight Savings Time Disabled. The panel will make no automatic time adjustments for daylight savings time.
[7]-[8]	Future Use

[018] Sixth System Options

Option	Description
[1]-[4]	Future Use
[5]	ON: Keypad Buzzer Follows Bell Enabled. The keypad buzzers will follow the partition's bell activity. The buzzer will turn on when the siren activates and the buzzer will turn off when the siren deactivates. OFF: Keypad Buzzer Follows Bell Disabled. The keypad buzzer will not follow bell activity. Only alarms designated to activate the keypad buzzer will do so.

[6] **Cross Zoning/Police Code** **ON: Cross Zoning is Enabled.** The panel will use the Cross Zone attribute for Burglary Verification. This feature requires two or more trips from a zone that has the Cross Zone attribute enabled within a specified time before starting an alarm sequence.

When a zone with cross zoning enabled is violated, no alarm occurs on the system; however, entry delay may start or the system event PGM may activate. The cross zoning timer will be started. If another zone with the cross zone attribute is violated before the timer expires, the panel will transmit the first alarm signal—a Cross Zone event, followed by the second zone alarm, and begins the appropriate local alarm sequence. If no other zones are violated before the timer expires, no alarm sequence occurs and a Burglary Not Verified event is logged in the buffer. If the double hit feature is enabled, the panel will react to two violations of the same zone during the cross zoning timer and start the alarm sequence. This option will not function for zones that don't create alarm conditions (day zone while disarmed, instant zone while disarmed, etc.)

Note: The cross zoning timer counts in seconds when this feature is enabled. Police code timer counts in minutes when this feature is disabled.

Note: Fire Zones should never have cross zoning enabled.

OFF: Police Code is Enabled. The panel will use the police code feature for burglary verification.

[7] **Exit Delay Restart** **ON: Exit Delay Restart Enabled.** This CP-01 feature is used to prevent a false alarm caused by the user exiting and then immediately re-entering the protected area. If a delay zone is violated and restored during the exit delay, it is considered an exit. If a delay zone is then violated again, it is considered a re-entry. With this option enabled, the panel will restart the exit delay ONCE. Further violations of the same zone or other delay zones shall not restart the exit delay.

OFF: Exit Delay Restart Disabled. Delay zone violations and restores will not restart the exit delay.

[8] **AC Trouble Beeps** **ON: AC Trouble Beeps Enabled.** When an AC trouble occurs on the panel, all keypads will sound an audible trouble indication (2 beeps every 10 seconds).

OFF: AC Trouble Beeps Disabled. AC troubles will remain silent.

[020] Keypad Zone Assignment

Enter the two-digit zone number to be assigned to each keypad assigned to a specific slot. Only one keypad can be assigned to a specific slot. See also Section [020] Keypad Zone Assignments. Valid entries are from [00] to [08].

[022] Ninth System Options

Option Description

[1]-[7] Future use

[8] **ON: Audible Exit Delay for Stay Arming.** When the system is armed in stay mode, the exit delay will be sounded by 1 beep every 3 seconds.

OFF: Stay Arming is Silent. When the system is armed in stay mode, the exit delay will be silent.

[023] Tenth System Options

Option Description

[1]-[4] Future Use

[5] **ON: Switching from Away to Stay Disabled.** The system cannot be switched from Away to Stay mode by pressing the [Stay] Function key.

OFF: Away to Stay Toggling Enabled. The system can be switched from Away to Stay mode by pressing the [Stay] function key, but only if entry delay is not active and the system is not in alarm.

[6] Future Use

[7] **ON: Trouble Beeps are Silent.** When a trouble is detected on the system, trouble beeps will not be sounded at the system keypads.

OFF: Trouble Beeps are Audible. When a trouble is detected on the system, trouble beeps will be sounded at the system keypads.

[8] **ON: Keyswitch Arms in Away Mode.** When a keyswitch zone is used to arm the system, the panel will always arm in away mode, regardless of whether a delay zone was violated and restored during exit delay.

OFF: Keyswitch Arms in Stay or Away Mode. When a keyswitch is used to arm the system, the panel will arm in away mode if a delay zone is violated and restored during the exit delay, or if there are no stay/away zones on the system. If neither of these conditions is met, the panel will arm in stay mode.

[030] Zone Loop Response Options

Fast loop response for the onboard zones is programmable using Installer Programming Section [030]. Section [030] is an 8 bit toggle option that controls which main board zones will use fast loop response (~40mS) or normal loop response (~250mS).

Note: Fast loop response should not be enabled for zones that are "doubled" by using the zone doubler feature.

Option	Description
[1] ON: Zone 1 is Fast Loop Response	OFF: Zone 1 is Normal Loop Response
[2] ON: Zone 2 is Fast Loop Response	OFF: Zone 2 is Normal Loop Response
[3] ON: Zone 3 is Fast Loop Response	OFF: Zone 3 is Normal Loop Response
[4] ON: Zone 4 is Fast Loop Response	OFF: Zone 4 is Normal Loop Response

[101]-[108] Zone Attributes

The following options can be enabled or disabled for each zone. Pressing [9] in one of these sections brings the installer to the upper bank (attributes 9 to 16). From the upper bank, press [9] to return to the lower bank (attributes 1 to 8).

i	These attributes override default settings. Do NOT change fire zone attributes from their default settings.
----------	---

Option	Description
[1] Bell options	ON: An alarm activates the Siren. OFF: Silent alarm.
[2] Steady or Pulsed-Bell Type	ON: The bell output is steady when the zone is in alarm. OFF: The bell output pulses (1 sec on/off) when the zone is in alarm.
[3] Chime	ON: The keypad chimes when the zone is opened/closed. OFF: The zone does not chime the keypad when the zone is opened/closed.
[4] Bypass	ON: The zone may be manually bypassed in [*][1]. OFF: The zone cannot be manually bypassed in [*][1].
[5] Force Arming	ON: The zone can be violated and system arming will not be impeded. OFF: The system cannot be armed if the zone is open.
[6] Swinger Shutdown	ON: When the zone goes into alarm for the number of times programmed in the Swinger Shutdown Counter (see Section [377]), it shuts down with no further transmissions sent to the monitoring station. OFF: Swinger Shutdown is disabled. All alarms are transmitted and do not follow the Swinger Shutdown Counter.
[7] Transmission Delay	ON: Reporting of zone alarms (and police code) are delayed for the time programmed in Section [377]. OFF: When an alarm occurs, the reporting code is transmitted immediately.
[8] Not Used	
[9] Cross Zoning	ON: The zone can start or complete the cross zoning sequence. It can generate a confirmed burglary alarm. OFF: This zone type will not start or complete the cross zoning sequence. It cannot generate a confirmed burglary alarm.
[10]-[13] Not Used	
[14] Normally Closed Loops*	ON: If the zone type is assigned to an onboard zone, it will not require an end of line resistor if this option is enabled (Normally Closed Loops). This overrides the EOL configuration programmed in Section [013]. OFF: The zone type will follow the end of line configuration programmed in Section [013]
[15] Single End of Line (SEOL) Resistors*	ON: If the zone type is assigned to an onboard zone, it will require a single end of line resistor (SEOL). This overrides the EOL configuration programmed in Section [013]. OFF: The zone type will follow the end of line configuration programmed in Section [013]
[16] Double End of Line (DEOL) Resistors*	ON: If the zone type is assigned to an onboard zone, it will require double end of line resistors (DEOL). This overrides the EOL configuration programmed in Section [013]. OFF: The zone type will follow the end of line configuration programmed in Section [013]

* Some zone types only support single end-of-line configuration, regardless of how the panel is configured, such as Fire Zones which are always single end-of-line.

Daylight Savings Time

These sections are used to program the date, time and increment that the clock moves ahead for Daylight Saving Time each year. Daylight savings time can be programmed to adjust the time by 1 or 2 hours (backward or forward) at an exact date and time, or on a specific weekday of a specific month. To enable daylight saving's time, the installer must enable Option 6 in Section [017] and program Sections [168] and [169] to configure the system to change the time automatically for daylight savings. Enter [168] when setting the clock forward and enter [169] when setting the clock backward.

[168] Daylight Savings Time Begins

Month	[001] to [012] represents January to December.
Week	[000] indicates that the day of the month is programmed in the Day section below. [001] to [005] represents weeks 1 to 5 of the month. Week 5 always represents the last week in the month, regardless of whether the number of weeks in the month is 4 or 5.
Day	[001] to [031] represents the day of the month if [000] was programmed in the Week section above. If [001] to [005] was programmed in the Week section above, then [000] to [006] represents Sunday to Saturday.
Hour	[000] to [022] represents the hour that Daylight Saving Time takes effect.
Increment	[001] to [002] represents the number of hours to advance the clock for Daylight Savings Time.

i	Do not program the Hour outside of the valid range or the time will not change. Do not program the value of the Increment to be greater than the number of hours remaining in the current day.
----------	---

Example:

E.g., Set the clock 1 hour ahead at March 5th, 2006 at 2:00am.

1. Enter Section [168].
2. Program the first entry (Month) with 003 for March.
3. Program the second entry (Week) with 000 since the week doesn't matter in this example.
4. Program the third entry (Day) with 005 for the 5th.
5. Program the fourth entry (Hour) with 002 for 2 am.
6. Program the fifth entry (Interval) with 001, which correlates to a 1 hour change to the time of day.

[169] Daylight Savings Time Ends

These sections are used to program the date, time and increment that the clock moves back for Standard Time each year. The following attributes can be programmed:

Month	[001] to [012] represents January to December.
Week	[000] indicates that the day of the month is programmed in the Day section below. [001] to [005] represents weeks 1 to 5 of the month. Week 5 always represents the last week in the month, regardless of whether the number of weeks in the month is 4 or 5.
Day	[001] to [031] represents day of the month if [000] was programmed in the Week section above. If [001] to [005] was programmed in the Week section above, then [000] to [006] represents Sunday to Saturday.
Hour	[000] or [023] represents the hour that Standard Time takes effect.
Increment	[001] or [002] represents the number of hours to roll back the clock for Daylight Saving Time.

i	If Daylight Saving Time occurs at Midnight program the time 2:00AM.
----------	---

[170] PGM Output Timer

This value, programmable in seconds, is accessible by using Installer Programming Section [170]. This value represents the period of time that a PGM will activate if programmed to follow the PGM Timer. The default value is 005 seconds. Valid entries are 001-255 seconds, although some PGM types can be configured to latch. This timer does not affect PGM type 03, Sensor Reset.

Note: If a system event PGM is programmed to follow the Command Output Timer, all PGM attributes must be enabled.

[175] Auto-Arm Postpone Timer

In this section, program the time (in minutes) for which the system will postpone automatic arming if the auto-arming process is interrupted. After the programmed time, the system will attempt to auto-arm again. If [000] is entered in this section, the system will abort the auto-arm sequence instead of postponing it.

[176] Cross Zone/Police Code Timer

Program the time, in seconds (Cross Zone) or minutes (Police Code), that the panel uses to determine if a Cross Zone or Police Code event has occurred. If [000] is programmed when using the Police Code feature, the panel generates a Police Code event (if any two zones go into alarm during an armed-to-armed period). Valid entries are [000] to [255].

[181] Auto-Arm Time of Day

Program the desired auto-arming time of day in military time format, HH:MM. The PC1404 will attempt to auto-arm at this time every day unless the feature is disabled in [*][6] User Functions. Valid entries are 00:00 to 23:59, 99:99 to disable.

[190] No Activity Arming Pre-Alert

Program the time, in minutes, for the No Activity Arming Pre-Alert Duration. The keypad provides a steady tone warning the user that the system is arming. The user can either violate a zone or press any key to abort the arming sequence. Valid entries are [000] to [255].

[191] No Activity Arming Timer

Program the time, in minutes, for the No Activity Arm Timer. If any delay 1 zone is restored and no zone activity is detected on the system for the programmed duration, the system will start the automatic arming sequence. Valid entries are [000] to [255]. An entry of 000 disables this feature.

[199] Auto-Arming Pre-Alert Timer

In this section, program the time (in minutes) for the Auto-Arming Pre-Alert time. This timer is used for all programmed auto-arming features (it is not used for no-activity arming). The keypads will provide a steady tone, warning the user that the system is preparing to arm. The user can enter a valid access code, or valid disarming procedure, to abort the arming sequence. Valid entries are 001 to 255.

[301]-[303], [305] Communication Telephone Numbers

The information in this section applies to Sections [301], [302], [303] and [305].

These sections determine which type of communicator is activated in the event of an alarm condition or other communicated event. The PC1404 only supports one method of communications, PSTN. GPRS and Ethernet communicators are not supported.

- Entry of [D] followed by a [Telephone Number] terminated with “F” configures the section for telephone dialing.
E.g.: [D12223334444F]

Telephone Communications

All telephone number sections are 32 digits in length. Hexadecimal digits may be programmed in the telephone number to perform additional functions as follows:

- Enter [*][2][*] – HEX B to dial “*”
- Enter [*][3][*] – HEX C to dial “#”
- Enter [*][4][*] – HEX D for an additional dial tone search, as is required for PBX telephone systems
- Enter [*][5][*] – HEX E to insert a 2-second pause in the telephone number

i	There is an automatic 2-second pause before additional dial tone searches are initiated.
----------	--

HEX A is not used.

HEX F represents the end of the phone number (everything after F is ignored).

Pressing [#] in these sections exits and saves the entire phone number.

The panel does not attempt to communicate if no phone number is programmed. This applies to phone numbers 1 to 4.

[304] Call Waiting Cancel String

This is a 6-digit HEX entry that is used to disable the call waiting on a call waiting equipped phone line. This is typically *70 and is programmable using Installer Section [304]. Dialing this string before a phone number will disable call waiting for the duration of the call. If this section is programmed (not FFFFFFF), and Section [382] Option 4 is ON, the panel dials this string in place of the first digit of the phone number. This only applies to the first attempt that is made to each phone number. If 6 digits are not required, terminate the string with hex Fs to create a 6 digit string.

[310] System Account Number

Program the System Account Number, which will be used by the panel when communicating. Only the SIA format supports 6-digit account numbers. If a 4-digit account number is required, program the last two digits as data [FF]. If the account code needs to have a 0 in it, and the format is programmed as CID or BPS, a HEX digit A must be used to send a 0.

[320]-[324] Alarm Reporting Codes

These reporting codes are used by the communicator to transmit zone alarms and restores for Zones 1 to 8. These reporting codes are sent to the Alarm & Restore call direction group

i	Zone alarms transmit to the System Test Transmission Call Direction when they are being transmitted as part of the walk test (enabled if Section [382] Option [2] is ON).
----------	---

[328] Miscellaneous Alarm Reporting Codes**Duress Alarm**

This reporting code is transmitted whenever a Duress code is used to perform any function on the system. The reporting code is sent to the Alarm & Restore call direction group.

Opening After Alarm

This reporting code is transmitted when the system is disarmed after an alarm; if an alarm occurred during the previous armed period. The reporting code is sent to the Alarm & Restore call direction group.

Recent Closing

This reporting code is transmitted when an alarm occurs within two minutes of system arming.

Zone Expander Supervisory Alarm/Restore

This reporting code is generated when a keypad with a keypad zone enrolled is no longer responding to the panel on keybus. The reporting code is sent to the Alarm & Restore call direction group.

Police Code Alarm

Two zones on the same partition go into alarm during any given armed-to-armed period (including 24-Hr. zones).

[329] Priority Alarm and Restore Reporting Codes (Fire, Auxiliary, and Panic Alarms/Restores)

If enabled and used to generate manual alarms, these reporting codes are sent to the Alarm & Restore Call Direction group.

[330]-[334] Tamper/Restore Reporting Codes, Zones 01-8

These reporting codes are used by the communicator to transmit zone tampers and restores for Zones 1 to 8. These reporting codes are sent to the Tamper Alarm & Tamper Restore call direction group of the system.

[338] Miscellaneous Tamper Reporting Codes**General System Tamper & Restore**

These reporting codes are sent to the system Tamper Alarm & Tamper Restore call direction group when a panel tamper occurs.

Keypad Lockout

Whenever the system enters keypad lockout, this reporting code is sent to the system Tamper Alarm & Tamper Restore call direction group.

[339]-[340] Closing (Arming) Reporting Codes (Access Codes 1-32)

When the system is armed, a closing reporting code is transmitted after the exit delay expires for the user code that armed the system. These reporting codes are sent to the Opening & Closing call direction group of the system. In addition, "Armed in Stay Mode," "Armed in Away Mode" or "Armed in Night Mode" is logged to the event buffer.

[341] Miscellaneous Closing (Arming) Reporting Codes**Automatic Zone Bypassing**

This stops transmission of zone bypass information for systems set up for an automatic communication format (SIA and Contact ID). Enter [00] to disable the automatic zone bypassing communications. If the zones are to be identified, they are transmitted with the Partial Closing to the Opening & Closing call direction group. (24 Hour zone types transmit that they have been bypassed when the user exits the bypassing menu).

Partial Closing

If zones were manually bypassed at the time of arming, this reporting code is transmitted to the central station with the Closing code to warn of a security compromise. Automatic bypasses caused by Stay arming do not cause this code to be transmitted. Zones force armed by automatic arming transmit in the manner described above. If SIA is used, each zone is identified using the UB-XX (un-typed bypass) identifier. The identified zones follow the partial closing code and precede the closing transmission. This reporting code is sent to the Opening & Closing call direction group.

Special Closing

This reporting code is transmitted if the system is armed without an access code using Keyswitch Zone, Downloading, Quick Arm [*][0], or Stay or Away function keys. In addition, either "Armed in Stay Mode," "Armed in Away Mode," or "Armed in Night Mode" is logged to the event buffer for all closing types. This reporting code is sent to the Opening & Closing call direction group.

Late to Close

This reporting code is transmitted whenever the auto-arm prealert sounds (if the Late to Close option is enabled).

Exit Fault

If an Exit Error occurs and entry delay expires before the system is disarmed, this reporting code is sent. This reporting code is sent to the Openings & Closings call direction group

i

If the delay zone that caused the exit error has cross zoning enabled, the exit fault and zone alarm still transmit if a second zone is not violated. This is to inform the central station that the premise is not secure. The local alarm sequence follows the cross zoning rules. The exit error is transmitted with the zone alarm that caused the fault, even if that zone has a transmission delay enabled.

[342]-[343] Opening (Disarming) Reporting Codes (Access Codes 1-32)

When the system is disarmed, an opening Reporting code for the corresponding user is transmitted. These reporting codes are sent to the Opening & Closing call direction group.

[344] Miscellaneous Opening (Disarming) Reporting Codes**Auto-Arm Cancellation**

This reporting code is transmitted if Auto-Arming is Cancelled or Postponed.

Special Opening

If the system is disarmed (opened) by using keyswitch zone, an unidentified wireless key, or downloading, this reporting code is transmitted to the Opening & Closing call direction group.

[345]-[346] Maintenance Alarm and Restore Reporting Codes**Battery Trouble & Restore**

This trouble is reported if the standby battery is low or disconnected. These reporting codes are sent to the System Maintenance call direction group.

AC Failure Trouble & Restore

If the AC supply has failed or has been restored, these reporting codes are sent. A programmable delay (001-255 minutes, Section [377]) applies to both the trouble and the restore. These reporting codes are sent to the System Maintenance call direction group.

Bell Circuit Trouble

An open or short circuit detected across bell terminals causes this trouble to be reported.

Fire Trouble & Restore

An open circuit or any Low Sensitivity, Tamper or Fault report from a wireless smoke detector causes this trouble to be reported. These reporting codes are sent to the System Maintenance call direction group.

Auxiliary Power Supply Trouble & Restore

If an auxiliary voltage supply trouble occurs (the Aux PTC has caused the auxiliary supply to stop outputting power), this trouble is reported. These reporting codes are sent to the System Maintenance call direction group.

i	When the Aux Positive Temperature Co-efficient (electronic fuse) enters the open state due to a short or high current draw, if the short is removed and a load is still applied, the Aux+ output will not recover. It must be powered down and back up again to restore this condition.
----------	---

TLM Alarm

The TLM Restore code is sent when the telephone trouble condition is restored. This reporting code is sent to the System Maintenance call direction group.

General System Trouble & Restore

These reporting codes are transmitted via System Maintenance call direction group to report RF Jam troubles or hardware fault troubles that occur on the system.

General System Supervisory Trouble & Restore

These reporting codes are transmitted via the System Maintenance call direction group when an enrolled TLXXX module has been detected as absent or restored.

System Reset (Cold Start)

In the event of a total power failure, the Cold Start reporting code is transmitted to the central station when power is restored to the panel. The reporting code is sent after 2 minutes to allow the panel to stabilize, although the event is logged in the buffer at 00:00. An entry of 00 in this section disables the reporting code.

[347] Miscellaneous Maintenance Reporting Codes**Failure to Communicate (Phone Numbers 1, 2, 3 & 4)**

When events fail to communicate to either telephone number, this reporting code is transmitted the next time a communication is successful. The information is transmitted in the following order:

- Old Event(s)
- Failure To Communicate (Phone #1)
- New Event(s)

The FTC reporting code does not follow any call direction “group.” It is sent to every group’s call directions upon transmission of “failed to communicate” events. When event(s) fail to communicate to a telephone number, no attempt to communicate is made again until another event is sent to that phone number.

Event Buffer 75% Full

This reporting code is generated after 96 events have been logged to the system event buffer since the panel was last uploaded with DLS. This reporting code is sent to the system maintenance call direction group.

DLS Lead In and Lead Out

When call-back is enabled, the control panel transmits the DLS Lead In reporting code before calling back the downloading computer. The DLS Lead Out reporting code is transmitted by the panel every time DLS has completed a successful DLS session with the control panel. The DLS Lead In reporting code is transmitted in two ways: after the panel has been successfully called by DLS, but before the panel calls DLS back via the downloading telephone number when call-back is enabled, or upon a user-initiated call-up. These reporting codes are sent to the System Maintenance call direction group.

i	If DLS is terminated by an alarm, the alarm system will not communicate the DLS lead out event.
----------	---

General Zone Fault & Restore

This reporting code is sent whenever a zone has entered the fault state. This occurs when there is a short on DEOL hardwired zones and/or a loss of supervisory on a wireless zone. These reporting codes are sent to the System Maintenance call direction group.

Delinquency Reporting Code

The Delinquency Reporting code is transmitted in one of two ways. If Section [380] Option [8] is OFF, it is transmitted when the system has not been armed for the number of days programmed in Section [377]. If Section [380] Option [8] is ON, it is transmitted when no zone activity has been detected on the system for the number of hours programmed in Section [377]. This reporting code is sent to the System Maintenance call direction group.

i	The Activity Delinquency timer is active when the system is armed in Stay mode, and not active in Away mode or Night mode arming.
----------	---

Installer Lead In and Lead Out

The Installer Lead In and Lead Out reporting codes are sent when the panel enters and exits Installer Programming respectively.

[348] Test Transmission Reporting Codes

Walk Test Begin/End

These reporting codes are sent when the walk test is initiated and terminated. These codes precede and terminate the alarm reporting codes for the zones that are activated during the walk test period, if the alarms are to be transmitted (Section [382] Option [2]). The walk test reporting codes are sent to the System Test Transmission call direction group.

Periodic Test Transmission

When the programmed interval and time of day have elapsed, this reporting code is transmitted. This reporting code is sent to the System Test Transmission call direction group.

System Test

When the [*][6][Master Code][4] command is used to perform a manual system test, this reporting code is sent to test the communicator. This reporting code is sent to the System Test Transmission call direction group.

[350] Communications Format Options

This section requires four 2-digit entries (1 per phone number). See Appendix B: Communicator Format Options.

[351]-[376] Communicator Call Direction Options

Communicator call directions can be configured for 4 different phone numbers. Each reporting code falls under one of the following 5 groups:

- Alarms & Restores
- Openings & Closings
- Tamper & Restores (including System Tamper)
- System Maintenance Alarms & Restores
- System Test Transmissions

Each group can be assigned to the following call directions:

- Option 1: 1st Telephone Number
- Option 2: 2nd Telephone Number
- Option 3: 3rd Telephone Number
- Option 4: 4th Telephone Number

[377] Communicator Variables

Program a 3-digit number for each program entry:

Option Description

- [1] **Swinger Shutdown (Alarms):** Maximum number of alarm/restore transmissions per zone. Valid entries: [000] to [014]. Program data [000] to disable shutdown.
- [2] **Swinger Shutdown (Tamper):** Maximum number of tamper alarm/restore transmissions per zone. Valid entries: [000] to [014]. Program data [000] to disable shutdown.
- [3] **Swinger Shutdown (Maintenance):** Maximum number of trouble alarm/restore transmissions per trouble condition. Valid entries: [000] to [014]. Program data [000] to disable shutdown.
- [4] **Communicator (Transmission) Delay:** Time, in seconds, panel delays reporting an alarm event. Valid entries: [000] to [255].
- [5] **AC Failure Communication Delay:** Time in minutes or hours that panel delays reporting an AC trouble event or restore. Valid entries [000] to [255]
Note: AC Restore communications follow the same delay.
- [6] **TLM Trouble Delay:** Time, in 3 second checks, before the system considers the phone line disconnected. Valid entries: [003] to [255]
(e.g., 3 x 3 seconds = 9 seconds).
Note: TLM Restore follows the same delay.
- [7] **Test Transmission Cycle (Land Line):** Number of days between test transmission reporting events. Valid entries: [001] to [255]. [000] disables the Test Transmission.
- [8] For Future Use

- [9] **Delinquency Transmission Delay:** Number of hours (Activity Delinquency) or days (Arming Delinquency) the panel delays before transmitting the event to the central station. Whether this value is in hours or days is determined if Delinquency is for Activity (Hours) or Closing (Days) as specified in Section [380] Option 8. The timer starts under the following conditions:
1. When the system is armed in Stay Mode;
 2. When the system is disarmed;
 3. When a zone is violated and restored while system is disarmed or stay armed (Interior, Interior Delay, Interior Stay/Away, Delay Stay/Away, Interior Delay or Night zones only).
- The activity delinquency timer will be ignored when the system is armed in away mode. Zones that are bypassed in [*][1] will not reset the timer. Automatic restore conditions or activity from fire or CO zones should not reset this counter. If the system is programmed to monitor Closing Delinquency, the timer will be programmed in days. The timer will restart every time the system is disarmed. Valid entries: [001] to [255].

[10] For Future Use

[378] Test Transmission Time of Day

The panel can be configured to communicate a test transmission signal to the monitoring station. Program 4 digits – [HHMM] using military standard. For a test transmission at 11:00 pm, program data [2300]. Valid entries are [0000] to [2359], [9999] to disable.

[380] First Communicator Options

Option	Description
[1] Communications	ON: Communications Enabled. The system communicator is enabled and all events with reporting codes will be reported to the monitoring station. OFF: Communications Disabled. The communicator is disabled and events will not be transmitted to the monitoring station. Downloading may still be performed if enabled.
[2] Restore Transmission	ON: Restores Transmissions on Bell Time-out. Zone restore reporting codes will not be transmitted until the zone has been restored, the bell cut-off time has expired, and the zone is not in swinger shutdown. If the zone is not restored when the bell cut-off time expires, the restore will be transmitted when the zone physically restores or when the system is disarmed. Note: 24 Hr Zones will not restore until physically restored. OFF: Restore Transmissions Follow Zones. Zone restore reporting codes will be transmitted when the zone is physically restored and the zone is not in swinger shutdown. If the zones are still violated when the system is disarmed, the restore codes will be transmitted when the system is disarmed.
[3] Dialing Method	ON: Pulse Dialing Enabled. The panel uses rotary (pulse) dialing. OFF: DTMF Dialing. The panel uses touchtone (DTMF) dialing.
[4] Pulse Dialing Options	ON: Switch to Pulse Dialing after 4 DTMF Attempts. If DTMF dialing is enabled, the control panel dials telephone numbers using DTMF dialing for the first 4 attempts. If unsuccessful, the control panel switches to pulse (rotary) dialing for the remaining attempts. OFF: DTMF Dial for all Attempts. If DTMF dialing is enabled, the control panel dials telephone numbers using DTMF dialing for all dialing attempts.
[5]	Future Use
[6]	ON: Alternate Dialing Enabled. The communicator switches to the next backup phone number in the sequence after each failed dialling attempt. This continues until communications are successful, or the sequence has been repeated 5 times. OFF: Call Primary Number, Backup to Secondary. If 5 attempts to communicate to the primary telephone number fail, the communicator switches to the next backup and makes up to 5 more attempts. If the communication failure condition persists, the communicator will attempt the second and third backup phone numbers if programmed.
[7]	Future Use
[8] Delinquency	ON: Delinquency Follows Zone Activity (Hours). The Delinquency feature follows zone activity—if there is no zone activity on the system, the delinquency transmission delay counter in Section [377] begins counting in hours. When the counter reaches the programmed value, the panel communicates the delinquency code to the central station. Note: This code will not be transmitted for partitions that are “Away” armed. Activity on bypassed zones does not affect this timer. The timer is reset on arming. OFF: Delinquency Follows Arming (Days). The Delinquency feature follows arming—if a partition has not been armed for a programmed number of days, the panel communicates the delinquency code. This feature may be disabled by entering 000 in Section [377].

[381] Second Communicator Options

Option	Description												
[1] Ringback	<p>ON: Opening After Alarm Keypad Ringback Enabled. When the Opening After Alarm reporting code is successfully transmitted to the monitoring station, the keypad sounds a series of 8 beeps to confirm to the end user that the Opening After Alarm Code was sent and received. This Ringback occurs for each Opening After Alarm code successfully reported.</p> <p>OFF: Opening After Alarm Ringback Disabled. When the opening after alarm reporting code is successfully transmitted to the monitoring station, no keypad indications will be provided.</p>												
[2]	Future Use												
[3] SIA Reporting Codes	<p>ON: SIA Uses Programmed Reporting Codes. This option is for use with the SIA communication format. If 00 is programmed in the reporting code section, the event will not be communicated. When this option is ON and there is a valid reporting code programmed in the reporting code section, the programmed reporting code will be transmitted. If FF is programmed as a reporting code, the event will not be communicated.</p> <table border="0" style="width: 100%;"> <thead> <tr> <th style="text-align: left;">Reporting Code Entry</th> <th style="text-align: left;">Option ON</th> <th style="text-align: left;">Option OFF</th> </tr> </thead> <tbody> <tr> <td>00</td> <td>No Transmission</td> <td>No Transmission</td> </tr> <tr> <td>FF</td> <td>No Transmission</td> <td>Auto Rep Code Sent</td> </tr> <tr> <td>01-FE</td> <td>01-FE Sent</td> <td>Auto Rep Code Sent</td> </tr> </tbody> </table> <p>OFF: SIA Uses Automatic Reporting Codes. When this option is OFF and there is a valid reporting code (01-FE) or FF programmed in the reporting code section, the panel transmits an automatic reporting code for SIA only. This would be used when automatic reporting codes are required but there is a requirement for a different reporting code (like a pulse format).</p>	Reporting Code Entry	Option ON	Option OFF	00	No Transmission	No Transmission	FF	No Transmission	Auto Rep Code Sent	01-FE	01-FE Sent	Auto Rep Code Sent
Reporting Code Entry	Option ON	Option OFF											
00	No Transmission	No Transmission											
FF	No Transmission	Auto Rep Code Sent											
01-FE	01-FE Sent	Auto Rep Code Sent											
[4] Closing Confirmation	<p>ON: Closing Confirmation Enabled. The system beeps the keypad 8 times after successfully transmitting a Closing reporting event.</p> <p>OFF: Closing Confirmation Disabled. The keypad does not beep.</p>												
[5]-[6]	Future Use												
[7] CID Reporting Codes	<p>ON: Contact ID Uses Programmed Reporting Codes. The Contact ID communications format uses programmed reporting codes when transmitting to a central station.</p> <p>OFF: Contact ID Uses Automatic Reporting Codes. The Contact ID communications format uses automatic reporting codes as shown in Appendix A when transmitting to central station.</p>												
[8]	Future Use												

[382] Third Communicator Options

Option	Description
[1]	Future Use
[2] Walk Test Communications	<p>ON: Alarm Communications Enabled During Walk Test. The system transmits all alarms during Walk Test.</p> <p>OFF: Alarm Communications Disabled During Walk Test. The system does not report alarm events during Walk Test, even if alarms are programmed.</p>
[3] Communications Cancelled Message	<p>ON: Communications Cancelled Message Enabled. The Communications Cancelled (LCD) or CC (Icon) message will be displayed if alarms are acknowledged during the transmission delay time + arming cancellation window. This message will be displayed for 5 seconds on all keypads. The acknowledgement can be made with an access code, disarming function key or a Keyswitch zone.</p> <p>OFF: Communications Cancelled Message Disabled. The Communications Cancelled LCD message and CC Icon keypad message will not be created by any method.</p>
[4] Call Waiting Cancel	<p>ON: Call Waiting Cancel Enabled. The call waiting dialing string programmed in Section [304] will be dialed before the first attempt of each phone number. All subsequent dialing attempts to the same phone number will not use the call waiting cancel string.</p> <p>OFF: Call Waiting Cancel Disabled. The system does not dial the Call Waiting Cancel string.</p> <p>Note: A call waiting cancel on a non-call waiting line will prevent successful connection to the central station.</p>
[5]	Future Use
[6] AC Fail Communications Timing	<p>ON: System AC Failure Transmission Delay in Hours. The System AC Failure Transmission Delay in Section [377], Option 5 is programmed in hours.</p> <p>OFF: System AC Failure Transmission Delay in Minutes. The System AC Failure Transmission Delay in Section [377], Option 5 is programmed in minutes.</p>

- [7] **Residential Dial** **ON: Number of Dialing Attempts is 1 for Residential Dial.** If the residential dial format is programmed, the panel will only attempt to call the user's phone once. Regardless of whether the alarm is acknowledged by the end user by pressing a DTMF digit, the panel will not call back unless a new alarm has occurred.
OFF: Residential Dialing Attempts is 5. If the residential dial format is programmed the panel will attempt to call the user's phone until the alarm is acknowledged. The panel will attempt to call the user up to 5 times if no DTMF digits are detected.
- [8] Future Use

[383] Fourth Communicator Options

- | Option | Description |
|----------------------------------|---|
| [1] | Future Use |
| [2]
PH#2 Backup Option | ON: PH#2 Backs Up PH#1. Phone number 2 backs up phone number 1 if phone number 1 fails to communicate (FTC). Phone number 2 communicates using the same format as phone number 1 when this option is ON.
OFF: PH#2 is Dedicated. Phone number 2 does NOT back up phone number 1. Events are communicated to PH#2 if the call directions are enabled for it, and the format is programmable in Section [350]. |
| [3]
PH#3 Backup Option | ON: PH#3 Backs Up PH#2. Phone number 3 backs up phone number 2 if phone number 2 fails to communicate (FTC). Phone number 3 communicates using the same format as phone number 2 when this option is ON.
OFF: PH#3 is Dedicated. Phone number 3 does NOT back up phone number 2. Events are communicated to PH#3 if the call directions are enabled for it, and the format is programmable in Section [350]. |
| [4]
PH#4 Backup Option | ON: PH#4 Backs Up PH#3. Phone number 4 will back up phone number 3 if phone number 3 fails to communicate (FTC). Phone number 4 communicates using the same format as phone number 3.
OFF: PH#4 is Dedicated. Phone number 4 does NOT back up phone number 3. Events are communicated to PH#4 if the call directions are enabled for it, and the format is programmable in Section [350]. |
| [5]
FTC Option | ON: FTC Events Communicate. The panel will attempt to retransmit events that have failed to communicate. The FTC Restore reporting code is transmitted via the corresponding call direction.
OFF: FTC Events Do Not Communicate. The panel will not attempt to retransmit events that have failed to communicate. |
| [6]-[8] | Future Use |

[401] Downloading Option Codes

- | Option | Description |
|--|--|
| [1]
Answering Machine Override | ON: Answering Machine Override Enabled. The system will answer calls for downloading if a successful double call routine is detected by the panel. Have the downloading computer call the system and let the phone line ring once or twice. After 1 or 2 rings, hang up. If called back within the programmed double call time (000 to 255 seconds), the panel will answer on the first ring.
OFF: Answering Machine Override Disabled. The system will not answer incoming calls using the double call routine unless the user enables the DLS window. This option can be enabled by turning Option 2 in Section [401] ON. |
| [2]
DLS Window | ON: User Can Enable DLS Window. The user can use [*][6][Master Code][5] to enable a 6 hour window in which the panel will answer calls for downloading if a successful Double Call routine is detected. If this option is enabled, the window is open upon power up. The window is on for the full 6 hours if enabled.
OFF: User Cannot Enable DLS Window. The user cannot enable a window for DLS calls.
Note: Options 1 and 2 are not related. One does not need to be enabled for the other to perform its function. |
| [3]
Call Back | ON: Call-Back Enabled. When the system answer the downloading computer's call, both the computer and the panel will hang up. The panel will then call the downloading computer's telephone number programmed in Section [402], and connect to the DLS computer. If more than one downloading computer is used, this option should be disabled.
OFF: Call-Back Disabled. The downloading computer will have immediate access to the panel once it is identified as a valid system. |
| [4]
User Call-up | ON: User Call-up Enabled. When this feature is enabled, the user may initiate a single call of the Downloading Telephone Number by entering [*][6][Master Code][6].
OFF: User Call-up Disabled. An error tone will be generated when [*][6][Master Code][6] is entered. |
| [5]
Auto-Event Buffer Upload | ON: Auto Event Buffer Upload Enabled. After the panel has communicated the "Event Buffer 75% Full" event to the central station, the panel will call the Downloading Computer's telephone number. DLS software will then perform an event buffer upload upon successful connection.
Note: The DLS software must be waiting for the incoming call, and have a batch file configured to perform this function.
OFF: Auto Event Buffer Upload Disabled. After the panel has communicated the "Event Buffer 75% Full" event to central station, the panel will not call the Downloading Computer's telephone number. |

[6]
Baud Rate
Selection

ON: 300 Baud Call-up. 300 baud is the minimum baud rate used by 56K modems. When performing call-back or user initiated call-up with a 56K modem, this option should be enabled.
OFF: 110 Baud Call-up. 110 baud is the supported baud rate for the MD-12 modem. When performing call-back or user initiated call-up with an MD-12, this toggle option should be disabled.

[7]-[8] Future Use

[402] DLS Downloading Computer's Telephone Number

This is a 32-digit hexadecimal programming section. The downloading computer telephone number is for user-initiated call-up and call-back DLS functions. Program the phone number as required. HEX digits can be included for special applications:

- HEX [A] Not used
- HEX [B] Simulates a [*] key press
- HEX [C] Simulates a [#] key press
- HEX [D] Additional dial tone search
- HEX [E] 2-second pause
- HEX [F] End of phone number marker

[403] DLS Downloading Access Code/ Panel ID Code

This 6-digit hexadecimal code allows the panel to confirm that it is communicating with a valid downloading computer. The DLS access code in the panel and the DLS computer must match.

Note: The Downloading Access Code MUST BE PROGRAMMED BY THE INSTALLER. For security reasons this value must never be left at default.

[404] Panel ID Code

Program the 6-digit Panel Identification Code. This code is used by the downloading computer to verify the correct account is calling back (Call Back feature) or to identify which customer account file should be used (User Initiated DLS features). It is not used if the DLS computer calls the panel.

[405] Double Call Timer

Program the maximum time in seconds, between calls, when connecting to the panel using the Double Call feature.

[406] Number of Rings to Answer On

The value in this section determines how many rings the panel will automatically pick up on in order to establish a DLS connection. Default value is 000 rings. Valid entries are [000] to [020].

i If Section [401] Option 1 is enabled, and there is a value greater than 000 in Section [406], either method will allow a DLS connection depending on how the installer calls the premises.

[501]-[514] PGM Output Attributes

Allows the installer to customize PGM attributes. The following attributes can be enabled or disabled for each PGM output. When a PGM option is changed, the corresponding PGM's attributes are defaulted.

Option Description

[1]-[2] Future Use

[3] **Output Level**

ON: Output energizes when activated.
OFF: Output de-energizes when activated.

[4] **Output Options**

ON: Output Pulsed. When using [*][7], the output activates for the duration programmed in the PGM output timer, Section [170]. The default activation time is 5 seconds.
OFF: Output On/Off. The output toggles between on and off when the corresponding [*][7] command is entered.

[5] **Access Code Options**

ON: Access code required for activation.
OFF: No access code required for activation.

Note: PGM Attribute 3 applies to PGM types 01, 03, 05, 06, 07, 08, 11, 12, 13, 14, 15, 17, 18, 19, 20, 21, 22, 25, 27, 29 and 30.

Note: PGM Attribute 4 applies to PGM types 11, 19, 20, 21 and 22.

Note: PGM Attribute 5 applies to PGM types 19, 20, 21, and 22.



The following attributes are available for the System Trouble PGM Option [09].

System Trouble PGM (Type 09)

- [1] Service Required
- [2] A.C. Failure
- [3] Telephone Line Fault
- [4] Communications (Failure to Communicate)
- [5] Device (Fire) Fault / WLS Zone Supervisory Fault Enabled
- [6] Device Tamper—hardwired or wireless device
- [7] Device Low Battery—wireless device
- [8] Loss of Clock

The following attributes are available for the System Event PGM Option [10]

System Event PGM (Type 10)

- [1] Burglary Delay, Instant, Interior, Stay/Away, Night, and 24 Hour Burglary Zone Types
- [2] Fire  Key, Fire zone
- [3] Panic  Key and Panic zones
- [4] Medical  Key, Medical, and Emergency zones
- [5] Supervisory Supervisory, Freeze, and Water zones
- [6] Priority Gas, Sprinkler, CO, 24-Hour Heat and 24-Hour non-Latching Tamper zones
- [7] Hold-up Duress alarms
- [8] Output Options **ON:** Output Follows PGM Timer (Attribute 8). The output activates for the duration programmed for the PGM output timer (Section [170]).
OFF: Output is latched. The output is active until a valid access code is entered.

i	If a system event PGM is programmed to follow the command output timer (Attribute 8 On), all other PGM attributes must be enabled.
----------	--

[551-564] Extended PGM Attributes for PGM Type 29, Zone Follower [551]-[564]

The following attributes are available for the Zone Follower PGM Option [29]:

- [1]-[2] Future Use **ON:** Output energizes when activated
- [3] Output level **OFF:** Output de-energizes when activated
- [4]-[7] Future Use **ON:** AND Logic
- [8] Priority **OFF:** OR Logic

The following attributes are programmable in Installer Sections [551]-[564]. Depending on which PGM is used for zone follower (Onboard, PC5208 or PC5204), the attributes need to be changed in the appropriate section.

- Zone 1 **ON:** Zone 1 Enabled for Zone Follower
OFF: Zone 1 Disabled for Zone Follower
- Zone 2 **ON:** Zone 2 Enabled for Zone Follower
OFF: Zone 2 Disabled for Zone Follower
- Zone 3 **ON:** Zone 3 Enabled for Zone Follower
OFF: Zone 3 Disabled for Zone Follower
- Zone 4 **ON:** Zone 4 Enabled for Zone Follower
OFF: Zone 4 Disabled for Zone Follower
- Zone 5 **ON:** Zone 5 Enabled for Zone Follower
OFF: Zone 5 Disabled for Zone Follower
- Zone 6 **ON:** Zone 6 Enabled for Zone Follower
OFF: Zone 6 Disabled for Zone Follower
- Zone 7 **ON:** Zone 7 Enabled for Zone Follower
OFF: Zone 7 Disabled for Zone Follower
- Zone 8 **ON:** Zone 8 Enabled for Zone Follower
OFF: Zone 8 Disabled for Zone Follower

[601] Closing by Master Code

When the system is armed, a closing reporting code is transmitted after the exit delay expires for the master code that armed the system. This reporting code is sent to the Opening & Closing call direction group of the system. In addition, either “Armed in Stay Mode” or “Armed in Away Mode” is logged to the event buffer.

[605] Opening by Master Code

When the system is disarmed, an opening Reporting code for the Master code is transmitted. These reporting codes are sent to the Opening and Closing call direction group.

[700] Automatic Clock Adjust

The value entered here adds or subtracts seconds at the end of each day to compensate for inaccuracies in the system time. Valid entries are 00-99, with 60 seconds being the default. To determine the value to be programmed in this section, perform the following:

1. Monitor the time lost by the panel over a period of time.
2. Calculate the average amount of time per day the panel gains or loses.
3. Add or subtract this value (seconds) from 60 and enter the value.

Example 1: The clock loses an average of 9 seconds a day. Solution: Instead of loading 60 seconds for the last minute of each day, program the panel to load 51 seconds in Section [700]. This will speed up the panel by 9 seconds every day, correcting the problem.

Example 2: The clock gains an average of 11 seconds a day. Solution: Program the panel to adjust the clock by 71 seconds for the last minute of each day in Section [700]. This will slow down the panel's clock by 11 seconds, correcting the problem.

[701] First International Options

Option		Description
[1]	AC Configuration	ON: 50 Hz AC. The incoming AC power cycles at 50Hz. OFF: 60 Hz AC. This is the North American standard where the incoming AC power cycles at 60Hz.
[2]	Crystal Time Base	ON: Crystal Time Base Enabled. The system uses the internal crystal for the internal panel clock; used in case of unstable AC power output. OFF: Crystal Time Base Disabled. The 50Hz or 60Hz AC power input is usually very stable and can be used to keep time.
[3]	Arming Inhibit	ON: AC/DC Arming Inhibit and Battery Check Enabled. When an AC or DC trouble is present, the system will not arm. This includes Keypad, Keypad, Automatic and DLS arming. If enabled and arming is attempted, the system will perform a System Battery check as well as a Battery Check on all peripheral modules that support a backup battery (PC5204, PC5200). OFF: AC/DC Arming Inhibit Disabled. The system can be armed, regardless of the presence of an AC or DC trouble, and will not check system batteries upon arming. It is highly recommended that AC troubles be displayed if this option is used (Section [016] Option 1).
[4]	Latching System Tamper	ON: All System Tamper Require Installer Reset. If any system tamper condition occurs, which includes module and zone tampers, the Installer Code must be entered before the system is permitted to arm. The tamper condition must also be restored prior to entering Installer Programming to reset the condition. All arming methods are impeded, including auto-arming and no activity arming. The latched tamper can also be reset via DLS. OFF: System Tampers Do Not Require Installer Reset. If any system tamper condition occurs, an installer reset is not required.
[5]	Access Code Length	ON: 6-digit User Access Codes. All access codes are 6 digits long except the panel ID code and the DLS Access code. -System Master Code = XXXX56 XXXX = Previous Code (1234) -Installer Code = YYYY55 YYYY = Previous Code (5555) OFF: 4-digit User Access Codes. All access codes are 4 digits long. If any 6 digit user codes are programmed, the last 2 digits are removed.
[6]	Busy Tone Detection	ON: Busy Tone Detection Enabled. If a busy tone is detected, the communicator will release the phone line and try to place the call again after the Delay Between Dialing Attempts counter has expired. OFF: Busy Tone Detection Disabled. The communicator will use the standard dialing procedure for each attempt, and shall wait 40 seconds for a handshake after dialing a phone number, even if the number being called is busy.
[7]-[8]	Future Use	

[702] Second International Options

Option		Description
[1]	Pulse Dialing Option	ON: Pulse Dialing Make/Break ratio is 33/67. The communicator uses 33/67 make/break ratio when pulse dialing. OFF: Pulse Dialing Make/Break ratio is 40/60. The system uses 40/60 make/break ratio.
[2]	Force Dialing	ON: Force Dialing Enabled. If the first attempt by the panel to call the monitoring station fails to detect a dial tone, on every subsequent attempt the panel will dial regardless of the presence of dial tone. OFF: Force Dialing Disabled. The system dials the programmed telephone number only if dial tone is detected.
[3]	Future Use	Future Use
[4]	Handshake	ON: 1600Hz Handshake. The communicator responds to a 1600Hz handshake for BPS formats. OFF: Standard Handshake. The communicator responds to the handshake designated by the format selected (1400Hz or 2300Hz).

[5]	I.D. Tone	<p>ON: ID Tone Enabled. After the telephone number is dialed, the panel will emit a tone (as specified by Option 6).</p> <p>OFF: ID Tone Disabled. After the telephone number is dialed, the panel will not emit an I.D. Tone.</p>
[6]	I.D. Tone Frequency	<p>ON: 2100 Hz I.D. Tone. After the telephone number is dialed, the panel will emit a 2100 Hz ID tone if enabled in Section [701] Option 5.</p> <p>OFF: 1300 Hz. ID Tone. After the telephone number is dialed, the panel will emit a 1300 Hz ID tone if enabled in Section [701] Option 5.</p>
[7]	Future Use	
[8]	Future Use	

[703] Delay Between Dialing Attempts

For standard (force) dialing, the panel will go off-hook, search for dial tone for 5 seconds, hang-up for 20 seconds, go off-hook, search for dial tone for 5 seconds, and then dial. If there is no initial handshake recognized within 40 seconds, the panel will hang up. This programmable timer in Section [703] adds a delay before the next call is attempted, and is defaulted to 001 for a total of 6 seconds.

[900] Panel Version

This section will display the panel version, 0100.

[901] Installer Walk Test Mode Enable/Disable

The Installer Walk Test can be used to test the alarm state of each zone of the panel. Before beginning the walk test, ensure the following conditions are met:

1. The panel is disarmed.
2. The keypad blanking option is disabled (Section [016]: [3]).
3. The fire bell is continuous option is disabled (Section [014]: [8]).
4. The transmission delay is disabled, if transmission delay is not required (Section [377]).

Note: Fire Troubles are not supported in walk test. They will be visible when walk test ends.

To perform a walk test, do the following:

1. Enter Installer Programming.
2. Enter Section [901].

When any zone is violated, the panel activates the bell output for 2 seconds, logs the event to the event buffer, and communicates the condition to the monitoring station if programmed to do so. Check the event buffer or alarms in memory to ensure that all zones and FAP keys are functioning properly.

Note: If there is no zone activity on the system for a period of 15 minutes, the system ends walk test mode and returns to the normal state.

To stop the test, you must do the following:

1. Enter Installer Programming.
2. Enter Section [901].

Zones do not have to be restored to stop the test. The system will not create an alarm condition for zones still violated when walk test ends. The zones will need to be restored and a new alarm must be detected.

Note: The Alarm Memory is cleared upon entering Walk Test mode. When the walk test is complete, the Alarm Memory will indicate the zones tested. The Alarm Memory will be cleared the next time the panel is armed.

Note: While the walk test is in progress, the Armed, Ready and Trouble LEDs will flash at a rapid rate. At the start of the walk test, a TS (test begin) signal will be communicated. When the test is stopped, a TE (test end) signal is communicated.

[902] Module Supervision Reset

All modules will automatically enroll within one minute upon power-up. If modules are to be removed, this section should be entered after the removal of the modules so that it may clear any supervisory troubles that may still be present. When this mode is entered, the system will re-evaluate the components of the system.

Note: It may take up to a minute to enroll or delete a module. Before entering Section [903] to view the module field, this time should be taken into account.

If there is a module that is not communicating properly with the system and this section is entered, the module will be deleted from the system. Once the module supervision reset is performed, all pending supervisory trouble restore reporting codes will not be logged or transmitted.

[903] View Module Supervision

In this mode, the system displays all of the modules presently enrolled on the system as indicated by the corresponding lights below:

Indicator Light	Module
1-8	Keypads 1-8
18	PC5208
19	PC5204
26-29	PC520X 1-4

[990] Installer Lockout Enable

If enabled, the panel gives a distinctive audible indication on power-up (the phone line relay clicks 10 times). This feature has no effect on a software default (all programming will return to the factory defaults). However, if a hardware default is attempted while Installer Lockout is enabled, the default does not occur, and the fraudulent attempt is logged to the event buffer.

To enable Installer Lockout perform the following:

1. Enter Installer Programming.
2. Enter Section [990].
3. Enter the Installer Code.
4. Enter Section [990] again.

[991] Installer Lockout Disable

If Installer Lockout is disabled, the panel will restore all programming to factory defaults if a hardware or software default is performed on the main control panel.

To disable Installer Lockout perform the following:

1. Enter Installer Programming.
2. Enter Section [991].
3. Enter the Installer code.
4. Enter Section [991] again.

Factory Default Main Panel (Hardware)

Perform the following to restore the main control panel to its default settings:

1. Remove AC and battery from panel.
2. Remove all wires from the Zone 1 and PGM1 terminals.
3. With a piece of wire, short the Zone 1 terminal to the PGM1 terminal.
4. Apply AC power to the main panel.
5. When Zone 1 is lit on the keypad (or when Zone 1 shows as open on an LCD keypad) the default is complete.
6. Remove AC Power from the control panel.
7. Reconnect all original wiring and power up the panel.

NOTE: The panel will not default unless AC is used to power the panel.

[999] Restore Panel Factory Defaults

Perform the following to return control panel programming to its factory defaults:

1. Enter Installer Programming.
2. Enter Section [999].
3. Enter the Installer Code.
4. Enter section [999] again.

6 Testing & Troubleshooting

Testing:

- Power up system
- Program options as required (see Section 5 Programming Worksheets)
- Violate, then restore zones
- Verify correct *Reporting Codes* are sent to the central station

Troubleshooting:

- Power up system
- Enter [*][2] to view *Troubles*
- Perform actions indicated in the tables below

Trouble Summary:

Trouble [1] Service Required - Press [1] or * for more information:

- 1 - Low Battery
- 2 - Bell Circuit Trouble
- 3 - General System Trouble
- 4 - General System Tamper
- 5 - General System Supervisory
- 6 - Not Used
- 7 - PC5204 Low Battery
- 8 - PC5204 AC Fail

Trouble [2] - AC Trouble

Trouble [3] - Telephone Line Trouble

Trouble [4] - Failure to Communicate

Trouble [5] - Zone Fault - Press [5] or * for more information

Trouble [6] - Zone Tamper - Press [6] or * for more information

Trouble [7] - Not Used

Trouble [8] - Loss of Time or Date - Press * to program date and time

Trouble	Cause	Troubleshooting
Trouble [1] Service Required		Press [1] to determine specific trouble
[1] Low Battery	Main panel battery less than 11.1 VDC Note: This trouble condition will not clear until the battery voltage is 12.5 VDC min., under load.	Note: If battery is new, allow 1 hour for battery to charge. Verify voltage measured across AC terminals is 16-18 VAC. -Replace transformer if required. Disconnect battery wire leads. • Verify battery charging voltage measured across battery leads = 13.70 - 13.80 VDC. Connect battery, remove AC power. • Verify measured voltage across battery terminals is 12.5 VDC min.
[2] Bell Circuit	Bell+, Bell-...Open Circuit	Disconnect Bell-/Bell+ wire leads, measure resistance of wire leads. • Open circuit indicates break in wiring or defective siren/bell. Jumper Bell+, Bell- with 1K resistor (Brown, Black, Red) • Verify trouble clears.
[3] General System Trouble	PC5204 Output #1 Open Circuit	If Output #1 is unused: • Ensure that terminals O1, AUX are jumpered with 1K resistor (Brown, Black, Red). If Output #1 is used: • Disconnect wire leads from O1, AUX terminals, measure the resistance of the wire leads. Open circuit indicates a break in the wiring.

Trouble	Cause	Troubleshooting
	PC520X Aux Power Supply Trouble	<ul style="list-style-type: none"> Ensure that a the power supply aux power terminal is not shorted to ground. Ensure that the maximum power supply aux current has not been exceeded.
[4] General System Tamper	Tamper input on module(s) open circuit	Short tamper terminal to COM terminal on unused modules connected to KEYBUS (PC5200, PC5204, PC5208, PC5601).
[5] Module Supervision	<p>Panel does not communicate with module(s) on KEYBUS</p> <p>Keypad assigned to incorrect slot</p>	<p>Modules are immediately enrolled and supervised when detected on the KEYBUS. If a module has been removed, or if the slot assignment of a keypad has been changed, module supervision must be reset.</p> <ul style="list-style-type: none"> View the event buffer (via DLS or LCD5500 keypad) to identify the specific modules in trouble. To reset module supervision: <ul style="list-style-type: none"> -Enter Programming Section [902]. -Press [#] (wait 1 minute for panel to scan KEYBUS). Enter Programming Section [903] to identify modules connected to the KEYBUS.
[6] Not Used		
[7] PC520X Low Battery	<p>PC520X battery less than 11.5VDC</p> <p>Note: This trouble condition will not clear until the battery voltage is 12.5VDC min., under load.</p>	See [1] Low Battery above.
[8] PC520X AC Failure	No AC at PC5204 AC inputs	Verify voltage measured across AC terminals is 16-18VAC. Replace transformer if required.

Trouble [2] AC Failure		
AC Failure	No AC at panel AC input terminals.	<ul style="list-style-type: none"> Verify voltage measured across AC terminals is 16-18VAC. Replace transformer if required.

Trouble [3] Telephone Line Trouble

Telephone Line Trouble	Phone line voltage at TIP, RING on main panel is less than 3VDC.	<p>Measure the voltage across TIP and RING on the panel:</p> <ul style="list-style-type: none"> No phone off-hook – 50VDC (approx.) Any phone off-hook – 5VDC (approx.) <p>Wire incoming line directly to TIP and RING.</p> <ul style="list-style-type: none"> If trouble clears, check wiring or the RJ-31x phone jack.
------------------------	--	---

Trouble [4] Failure to Communicate

Failure to Communicate	Panel fails to communicate one or more events to central station.	<p>Connect a handset to TIP and RING of the control panel. Monitor for the following conditions:</p> <p>Continuous dial tone</p> <ul style="list-style-type: none"> Reverse TIP and RING. <p>Recorded operator message comes on</p> <ul style="list-style-type: none"> Verify correct phone number is programmed. Dial the number programmed using a regular telephone to determine if a [9] must be dialed or if 800 service is blocked. <p>Panel does not respond to handshakes</p> <ul style="list-style-type: none"> Verify the format programmed is supported by the central station. <p>Panel transmits data multiple times without receiving a handshake</p> <ul style="list-style-type: none"> Verify that the account number and reporting codes are correctly programmed. <p>Contact ID and Pulse formats</p> <ul style="list-style-type: none"> Program a HEX [A] to transmit a digit [0]. <p>SIA format</p> <ul style="list-style-type: none"> Program a digit [0] to transmit a digit [0].
------------------------	---	--

Trouble	Cause	Troubleshooting
Trouble [5] Zone Fault Press [5] to determine specific zones with a Fault trouble		
	Open circuit is present on one or more fire zones on the main panel or zone expander	<ul style="list-style-type: none"> • Ensure fire zones have a 5.6K resistor (Green, Blue, Red) connected. • Remove the wire leads from Z and COM terminals and measure the resistance of the wire leads. <ul style="list-style-type: none"> - An open circuit indicates a break in the wiring or resistor not connected. • Connect a 5.6K resistor (Green, Blue, Red) across the Z and COM terminals. Verify the trouble condition clears.
	An open circuit is present on PGM 2 being used as a 2-wire smoke detector input	<ul style="list-style-type: none"> • Ensure the correct 2.2K end-of-line resistor is connected (Red, Red, Red). • Remove the wire leads from PGM2 and AUX+ terminals and measure the resistance of the wire leads. <ul style="list-style-type: none"> - An open circuit indicates a break in the wiring or no resistor connected. • Connect a 2.2K resistor (Red, Red, Red) across the PGM 2 and AUX+ terminals. Verify the trouble condition clears.
	A short circuit is present on one or more zones with double end-of-line resistors enabled	<ul style="list-style-type: none"> • Remove the wire leads from Z and COM terminals and measure the resistance of the wire leads. <ul style="list-style-type: none"> - A short circuit indicates a short in the wiring. • Connect a 5.6K resistor (Green, Blue, Red) across the Z and COM terminals. <ul style="list-style-type: none"> - Verify the trouble condition clears.
Trouble [6] Zone Tamper Press [6] to determine specific zones with a tamper trouble		
	An open circuit is present on one or more zones with double end-of-line resistors enabled.	<ul style="list-style-type: none"> • Remove the wire leads from Z and COM terminals. • Measure the resistance of the wire leads. <ul style="list-style-type: none"> -Open circuit indicates a break in the wiring. • Connect a 5.6K resistor (Green, Blue, Red) across the Z and COM terminals. • Verify the trouble condition clears.
Trouble [7] Not Used		
Trouble [8] Loss of Clock/Date		
Loss of time and date	The main panel internal clock is not set.	<p>To program the time and date:</p> <ul style="list-style-type: none"> • Enter [*][6][Master Code] then Press [1]. • Enter the time and date (in military) using the following format: HH:MM MM/DD/YY <p>Example.</p> <p style="padding-left: 20px;">For 6:00 pm, Nov. 30, 2007</p> <p>Enter: [18] [00] [11] [30] [07]</p>

Appendix A: Reporting Code Formats

The following tables contain Contact ID and Automatic SIA format reporting codes. See Programming Sections [320]-[348] for Reporting Codes.

Contact ID

The first digit (in parentheses) is automatically sent by the control. The second two digits are programmed to indicate specific information about the signal. For example, if zone 1 is an entry/exit point, you could program the event code as [34]. The central station would receive the following:

*BURG - ENTRY/EXIT - 1 where the "1" indicates which zone went into alarm.

SIA Format - Level 2 (Hard Coded)

The SIA communication format used in this product follows the level 2 specifications of the SIA Digital Communication Standard-October 1997. This format will send the Account Code along with its data transmission. The transmission will look similar to the following at the receiver:

Note: A system event will use the Area Identifier ri00.

N ri1= BA 01

N = New Event

ri1 = Partition /Area Identifier

BA= Burglary Alarm

01= Zone 1

Table 1: Reporting Codes

Section #	Reporting Code	Code Sent When...	Dialer Direction*	Automatic Contact ID Codes	SIA Auto Rep Codes**
[320]	Zone Alarms	Zone goes into alarm	A/R		
[324]	Zone Restores	Alarm condition has been restored	A/R		See the tables on next for details
[328]	Duress Alarm	Duress code entered at keypad	A/R	E(1)21-000	HA-00
[328]	Opening After Alarm	System disarmed with alarm in memory	A/R	E(4) 58-UUU	OR-UU
[328]	Recent Closing	Alarm occurs within two minutes of system arming	A/R	E(4)59-UUU	CR-UU
[328]	Zone Expander Supervisory Alarm/Rest.	Panel loses/restores supervisory transmission over the Keybus from zone expansion modules or keypads with zone inputs	A/R	E(1)43-000/ R(1) 43-000	UA-00/ UH-00
[328]	Cross Zone (Police Code) Alarm	Two zones on the same partition go into alarm during any given armed-to-armed period (incl. 24Hr zones)	A/R	E(1)39-000	BM-00/BV-00
[329]	[F] Key Alarm/Rest.	Keypad fire alarm (alarm and restore rep. codes sent together)	A/R	E(1)1A-000/ R(1)1A-000/	FA-00/FH-00
[329]	[A] Key Alarm/Rest.	Keypad auxiliary alarm (alarm and restore rep. codes sent together)	A/R	E(1)AA-000/ R(1)AA-000/	MA-00/MH-00
[329]	[P] Key Alarm/Rest.	Keypad panic alarm (alarm and restore rep. codes sent together)	A/R	E(1)2A-000/ R(1)2A-000	PA-00/PH-00
[329]	Auxiliary Input Alarm/Rest.	Option#23-24: a panic button wired to PGM 2 is pressed/ access code is entered. Option #04: a 2-wire smoke detector wired to PGM 2 goes into alarm/alarm is cleared.	A/R	E(1)4A-000/ R(1)4A-000 E(1)11-000/ R(1)11-000	UA-99/UH-99 FA-99/FH-99
[330], [334]	Zone Tamper/Restore	Zone is tampered / tamper condition restored	T/R	E(3)83-ZZZ/ R(3)83-ZZZ/	TA-ZZ/TR-ZZ
[338]	General System Tamper/Rest.	Case/cover has a tamper alarm. Case/cover tamper restored	T/R	E(1)45-000/ R(1)45-000	ES-00/EJ-00
[338]	Keypad Lockout	Maximum number of incorrect access codes has been entered at a keypad	T/R	E(4)61-000	JA-00
[339-341], [601]	Closings	System armed (user 01-39, 40 indicated)	O/C	R(4)A1-UUU	CL-UU
[341]	Automatic Zone Bypass	A zone was bypassed at the time of arming	O/C	E(5)7A-ZZZ	UB-ZZ
[341]	Partial Closing	One or more zones bypassed when system armed	O/C	E(4)56-000	CG-00
[341]	Special Closing	Closing (arming) using one of the following methods: quick arm, keyswitch, function key, maintenance code, DLS software, wireless key	O/C	R(4)AA-000	CL-00
[341]	Late to Close	Whenever the Auto-arm prealert sounds (if the Late to Close option is enabled)	O/C	R(4)54-000	CI-00
[341]	Exit Fault	Sent when an exit error occurs and the Entry Delay expires before the system is disarmed	O/C	E(3)74-ZZZ	EA-ZZ
[342-344], [605]	Openings	System disarmed (user 01-39, 40 indicated)	O/C	E(4)A1-UUU	OP-UU
[344]	Special Opening	Opening (disarming) using one of the following methods: keyswitch, maintenance code, DLS software, wireless key	O/C	E(4)AA-000	OP-00
[345]-[346]	Battery Trouble/Rest.	PC1404 System battery is low/battery restored.	MA/R	E(3)A2-000/ R(3)A2-000	YT-00/YR-00
[345]-[346]	AC Line Trouble/Rest.	AC power to control panel is disconnected or interrupted/ AC power restored (Both codes follow AC Failure Comm. Delay.)	MA/R	E(3)A1-000/ R(3)A1-000	AT-00/AR-00

Table 1: Reporting Codes

Section #	Reporting Code	Code Sent When...	Dialer Direction*	Automatic Contact ID Codes	SIA Auto Rep Codes**
[345]-[346]	Bell Circuit Trouble/Rest.	Software deactivates the bell output if a short is detected so no additional current is taken from the battery./Bell output restored.	MA/R	E(3)21-000/	YA-99/YH-99
[345]-[346]	Fire Trouble/Rest. 2-wire Smoke Trouble/Rest.	Trouble occurs/restore on a fire zone Trouble occurs/restore on 2-wire smoke detector zone	MA/R	E(3)73-000/ R(3)73-000	FT-00/FJ-00 FT/FJ-99
[345]-[346]	Auxiliary Power Trouble/Rest.	Aux voltage supply trouble/restore	MA/R	E(3)12-000/ R(3)12-000	YP-00/YQ-00
[346]	TLM Restore	Telephone line restored	MA/R	E(3)51-000	LR-01
[345]-[346]	Gen. System Trouble/Rest.	"Service Required" trouble occurs (view troubles using [*][2])/trouble restored	MA/R	E(3)AA-000	YX-00/YZ-00
[345]-[346]	Gen. System Supervisory Trouble/Rest.	Control panel has detected an alternate communicator fault/communications restored.	MA/R	E(3)3A-000	ET-00/ER-00
[346]	Cold Start	The PC1404 has restarted after total power loss.	MA/R	R(3)A5-000	RR-00
[347]	Phone 1-4 FTC Restore	Control panel has restored communications to central station on Phone 1, 2, 3 or 4 (after FTC)	MA/R	R(3)54-000	YK-00
[347]	Event Buffer is 75% Full	Event buffer is almost full since last upload	MA/R	E(6)22-000	JL-00
[347]	DLS Lead In	Downloading session start	MA/R	E(4)11-000	RB-00
[347]	DLS Lead Out	Downloading session complete	MA/R	E(4)12-000	RS-00
[347]	Zone Fault/Rest.	One or more zones have faults/restored	MA/R	E(3)8A-ZZZ/ R(3)8A-ZZZ/	UT-ZZ/UJ-ZZ
[347]	Delinquency	Programmed amount of time (days or hours) for delinquency has expired without zone activity, or without system being armed	MA/R	E(6)54-000***	CD-00
[347]	Installer Lead In	Installer's mode has been entered	MA/R	E(6)27-000	LB-00
[347]	Installer Lead Out	Installer's mode has been exited	MA/R	E(6)28-000	LS-00
[348]	Walk Test End	End of test	T	R(6)A7-UUU	TE-UU
[348]	Walk Test Begin	Beginning of test	T	E(6)A7-UUU	TS-UU
[348]	Periodic Test	Periodic system test transmission	T	E(6)A2-000	RP-00
[348]	System Test	[*][6] bell/communications test	T	E(6)A1-000	RX-00
*	A/R = alarms/restores; T/R = tampers/restores; O/C = openings/closings; MA/R = miscellaneous alarms/restores; T = test transmissions				
**	UU = user number (user 01-39, 40); ZZ = zone number (01-08).				
***	Use the "Fail to close" event code [(4)54] to report closing or activity delinquency. Ensure the central station is aware that this code is used.				

Table 2: Contact ID Programmed Zone Alarm/Restoral Event Codes

(as per SIA DCS: 'Contact ID' 01-1999): Program any of these codes for zone alarms/restores when using the standard (non-automatic) Contact ID reporting format.	
Medical Alarms	(1)34 Entry / Exit
(1)AA Medical	(1)35 Day / Night
(1)A1 Pendant Transmitter	(1)36 Outdoor
(1)A2 Fail to Report In	(1)37 Tamper
Fire Alarms	(1)38 Near Alarm
(1)1A Fire Alarm	General Alarms
(1)11 Smoke	(1)4A General Alarm
(1)12 Combustion	(1)43 Exp. Module Failure
(1)13 Water Flow	(1)44 Sensor Tamper
(1)14 Heat	(1)45 Module Tamper
(1)15 Pull Station	(1)4A Cross Zone Police Code
(1)16 Duct	24 Hour Non-Burglary
(1)17 Flame	(1)5A 24 Hour non-Burg
(1)18 Near Alarm	(1)51 Gas Detected
Panic Alarms	(1)52 Refrigeration
(1)2A Panic	(1)53 Loss of Heat
(1)21 Duress	(1)54 Water Leakage
(1)22 Silent	(1)55 Foil Break
(1)23 Audible	(1)56 Day Trouble
Burglar Alarms	(1)57 Low Bottled Gas Level
(1)3A Burglary	(1)58 High Temp
(1)31 Perimeter	(1)59 Low Temp
(1)32 Interior	(1)61 Loss of Air Flow
(1)33 24 Hour	

Table 3: Automatic Zone Alarm/Restoral Codes

Zone Definition	SIA Auto Rep Codes*	Contact ID Auto Rep Codes*	Contact ID Rest. Auto Rep Codes
Delay 1	BA-ZZ/BH-ZZ	E(1)3A-ZZZ	E(1)3A-ZZZ
Delay 2	BA-ZZ/BH-ZZ	E(1)3A-ZZZ	E(1)3A-ZZZ
Instant	BA-ZZ/BH-ZZ	E(1)3A-ZZZ	E(1)3A-ZZZ
Interior	BA-ZZ/BH-ZZ	E(1)3A-ZZZ	E(1)3A-ZZZ
Interior Stay/Away	BA-ZZ/BH-ZZ	E(1)3A-ZZZ	E(1)3A-ZZZ
Delay Stay/Away	BA-ZZ/BH-ZZ	E(1)3A-ZZZ	E(1)3A-ZZZ
24-Hr. Supervisory	US-ZZ/UR-ZZ	E(1)5A-ZZZ	E(1)5A-ZZZ
24-Hr. Supervisory Buzzer	UA-ZZ/UH-ZZ	E(1)4A-ZZZ	E(1)4A-ZZZ
24-Hr. Burg	BA-ZZ/BH-ZZ	E(1)3A-ZZZ	E(1)3A-ZZZ
24-Hr. Gas	GA-ZZ/GH-ZZ	E(1)51-ZZZ	E(1)51-ZZZ
24-Hr. Heat	KA-ZZ/KH-ZZ	E(1)58-ZZZ	E(1)58-ZZZ
24-Hr. Medical	MA-ZZ/MH-ZZ	E(1)AA-ZZZ	E(1)AA-ZZZ
24-Hr. Panic	PA-ZZ/PH-ZZ	E(1)2A-ZZZ	E(1)2A-ZZZ
24-Hr. Emergency	QA-ZZ/QH-ZZ	E(1)A1-ZZZ	E(1)A1-ZZZ
24-Hr. Water	WA-ZZ/WH-ZZ	E(1)54-ZZZ	E(1)54-ZZZ
24-Hr. Freeze	ZA-ZZ/ZH-ZZ	E(1)59-ZZZ	E(1)59-ZZZ
Interior Delay	BA-ZZ/BH-ZZ	E(1)3A-ZZZ	E(1)3A-ZZZ
Instant Stay/Away	BA-ZZ/BH-ZZ	E(1)3A-ZZZ	E(1)3A-ZZZ
Final Door Set	BA-ZZ/BH-ZZ	(1) 3A	(1) 3A
24-Hr. Non-latching Tamper	TA-ZZ/TR-ZZ	E(3)83-ZZZ	E(3)83-ZZZ
Day Zone	BA-ZZ/BH-ZZ	E(1)3A-ZZZ	E(1)3A-ZZZ
Night Zone	TA-ZZ/TR-ZZ	E(3)83-ZZZ	E(3)83-ZZZ
Delayed 24-Hr. Fire (Wireless)	FA-ZZ/FH-ZZ	E(1)1A-ZZZ	E(1)1A-ZZZ
Standard 24-Hr. Fire (Wireless)	FA-ZZ/FH-ZZ	E(1)1A-ZZZ	E(1)1A-ZZZ
24-Hr. Auto Verified Fire (Wireless)	FA-ZZ/FH-ZZ	E(1)1A-ZZZ	E(1)1A-ZZZ
24-Hr. CO Alarm	GA-ZZ/GH-ZZ	E(1)62-ZZZ	E(1)62-ZZZ
* ZZ = zones 01-08			

Appendix B: Communicator Format Options

The following format options are programmable in Section [350] Communicator Format Options

01 20 BPS, 1400 Hz handshake

02 20 BPS, 2300 Hz handshake

- BPS Formats - 0 is not valid in Account or Rep Code (A must be used).

Depending on the pulse format, the panel communicates using the following: 3/1, 3/2, 4/1 or 4/2, 1400 or 2300 Hz handshake, 20 bits per second, non-extended.

Digit "0" sends no pulses and is used as a filler. When programming account numbers enter four digits. When programming a three digit account number the fourth digit must be programmed as a "0" which will act as a filler digit. If an account number has a "0" in it, substitute a HEX digit "A" for the "0."

Examples:

- 3 digit account number [123]- program [1230]
- 3 digit account number [502] - program [5A20]
- 4 digit account number [4079] - program [4A79]

Two digits must be entered when programming reporting codes. If one digit reporting codes are used, the second digit must be programmed as "0". If "0" is to be transmitted, substitute a HEX digit "A" for the "0".

Examples:

- 1 digit reporting code [3] - program [30]
- 2 digit reporting code [30] - program [3A]

To prevent the panel from reporting an event, program the reporting code for the event as [00] or [FF].

03 DTMF Contact ID

- **ADEMCO Contact ID - 0 is not valid in Account or Rep Code (A must be used, 10 in checksum)**

Contact ID is a specialized format that communicates information quickly using tones rather than pulses. The format also allows more information to be sent. For example, rather than reporting an alarm zone 1, the Contact ID format can also report the type of alarm, such as Entry/Exit alarm zone 1.

If **Contact ID Sends Automatic Reporting Codes** is selected, the panel automatically generates a reporting code for each event. These identifiers are listed in Appendix A. If the Automatic Contact ID option is not selected, reporting codes must be programmed. The 2-digit entry determines the type of alarm. The panel automatically generates all other information, including the zone number.

NOTE:If Automatic Contact ID is selected, the panel automatically generates all zone and access code numbers, eliminating the need to program these items.

NOTE:The zone number for Zone Low Battery and Zone Fault events will not be identified when Pulse formats are used.

If the **Contact ID uses Automatic Reporting Codes** option is enabled, the panel will operate as follows:

- If an event's reporting code is programmed as [00], the panel will not attempt to call the central station.
- If the reporting code for an event is programmed as anything from [01] to [FF], the panel automatically generates the zone or access code number. See Appendix A for a list of transmitted codes.

If the **Contact ID uses Programmed Reporting Codes** option is enabled, the panel will operate as follows:

- If an event's reporting code is programmed as [00] or [FF], the panel will not attempt to call central station.
- If the reporting code for an event is programmed as anything from [01] to [FE], the panel will send the programmed reporting code.

Account numbers must be four digits:

- If the digit "0" is in the account number substitute the HEX digit "A" for the "0."
- All reporting codes must be two digits.
- If the digit "0" is in the reporting code substitute the HEX digit "A" for the "0."
- To prevent the panel from reporting an event, program the reporting code for the event as [00] or [FF].

See: Contact ID Sends Automatic Reporting Codes section [381], Option [7]

04 SIA FSK

- **SIA -0 is valid in Account or Rep Code (not 00 in a Reporting code)**
- **SIA -0 uses 300 Baud FSK as the communication media. Account Code can be 4 or 6 hexadecimal digits. Reporting codes must be 2 digits. The SIA format transmits a 4 (or 6) digit account code, 2 digit identifier code and 2 digit reporting code. The 2 digit identifier is pre programmed by the panel.**

SIA is a specialized format that communicates information quickly using frequency shift keying (FSK) rather than pulses. The SIA format automatically generates the type of signal being transmitted, such as Burglary, Fire, Panic etc. The two digit reporting code is used to identify the zone or access code number.

If the SIA format is selected the panel can be programmed to automatically generate all zone and access code numbers eliminating the need to program these items.

If the **SIA Sends Automatic Reporting Codes** option is enabled the panel will operate as follows:

1. If the reporting code for an event is programmed as [00] the panel will not attempt to call the central station.
2. If the reporting code for an event is programmed as anything from [01] to [FF] the panel will AUTOMATICALLY generate the zone or access code number.
3. During a partial closing, all bypassed zones are reported.

Communicator Call Direction Options can be used to disable reporting of events such as Openings/Closings. Also, if all the Opening/Closing reporting codes were programmed as [00] the panel would not report.

If the **SIA Sends Automatic Reporting Codes** option is disabled the panel operates as follows:

1. If the reporting code for an event is programmed as [00] or [FF] the panel will not attempt to call the central station.
2. If the reporting code for an event is programmed as anything from [01] to [FE] the panel will send the programmed reporting code.
3. During a partial closing, bypassed zones are not reported.

NOTE:The zone number for Zone Low Battery and Zone Fault events will not be identified when Programmed SIA is used.

See: **SIA Sends Automatic Reporting Codes - Section [381], Option [3],**

Communicator Call Direction Options - Section [351] to [376],

SIA Identifiers - Appendix A

06 Residential Dial

If Residential Dial is programmed and an event that is programmed to communicate occurs, the panel will seize the line and dial the appropriate telephone number(s). Once the dialing is complete, the panel will emit an ID tone and wait for a handshake (press a 1, 2, 4, 5, 7, 8, 0, * or # key from any telephone). It will wait for this handshake for the duration of **Post Dial Wait for Handshake** timer. Once the panel receives the handshake, it will emit an alarm tone over the telephone line for 20 seconds. If several alarms occur at the same time, only one call will be made to each telephone number the panel is programmed to call. If a handshake is not desired, turn Section [382] Option 7 ON so that the residential dial only makes one attempt.

07 10 BPS, 1400 Hz handshake**08 10 BPS, 2300 Hz handshake**

- BPS Formats - 0 is not valid in Account or Rep Code (A must be used).

Depending on the pulse format, the panel communicates using the following: 3/1, 3/2, 4/1 or 4/2, 1400 or 2300 Hz handshake, 10 or 20 bits per second, non-extended. Digit "0" sends no pulses and is used as a filler. When programming account numbers enter four digits. When programming a three digit account number, the fourth digit must be programmed as a "0" which will act as a filler digit. If an account number has a "0" in it, substitute a HEX digit "A" for the "0."

Examples:

- 3 digit account number [123] - program [1230]
- 3 digit account number [502] - program [5A20]
- 4 digit account number [4079] - program [4A79]

Two digits must be entered when programming reporting codes. If one digit reporting codes are used, the second digit must be programmed as "0". If "0" is to be transmitted, substitute a HEX digit "A" for the "0".

Examples:

- 1 digit reporting code [3] - program [30]
- 2 digit reporting code [30] - program [3A]

To prevent the panel from reporting an event, program the reporting code for the event as [00] or [FF].

09 Private Line (Eastern EU)

The private line format allows the communication of zone alarms directly to a user over a telephone line. When an event occurs that the panel is programmed to communicate, the panel seizes the line and dials the programmed telephone number(s). The panel then emits a double beep on the line every 3 seconds, regardless of what is happening on the phone line; it may still be ringing, sounding a busy tone, etc. The double beep indicates to the user receiving the call that the control panel is calling. The user must acknowledge the call by pressing 1, 2, 3, 4, 5, 6, 7, 8, 9, 0, * or # from any touchtone telephone. The panel will wait for this acknowledgement for the duration of the post dial wait for handshake timer (40 seconds).

The panel will then indicate which zone is in alarm by sounding a corresponding number of beeps (e.g. 3 beeps for zone 3). The user must then press a key to acknowledge the alarm. If the panel has another alarm to communicate, it will sound a corresponding number of beeps for the new zone alarm. The user must then press a key to acknowledge the signal. When there are no further alarms, the panel will hang up.

Note: Only alarm events are supported by Private Line. It's likely the panel will be unable to decode DTMF digits from some cell phones, and this feature will not operate correctly as a result.

Appendix C: Regulatory Approvals Information

North America

FCC COMPLIANCE STATEMENT

CAUTION: Changes or modifications not expressly approved by Digital Security Controls could void your authority to use this equipment.

This equipment has been tested and found to comply with the limits for a Class B digital device, pursuant to Part 15 of the FCC Rules. These limits are designed to provide reasonable protection against harmful interference in a residential installation. This equipment generates, uses and can radiate radio frequency energy and, if not installed and used in accordance with the instructions, may cause harmful interference to radio communications. However, there is no guarantee that interference will not occur in a particular installation. If this equipment does cause harmful interference to radio or television reception, which can be determined by turning the equipment off and on, the user is encouraged to try to correct the interference by one or more of the following measures:

- Re-orient the receiving antenna.
- Increase the separation between the equipment and receiver.
- Connect the equipment into an outlet on a circuit different from that to which the receiver is connected.
- Consult the dealer or an experienced radio/television technician for help.

The user may find the following booklet prepared by the FCC useful: "How to Identify and Resolve Radio/Television Interference Problems". This booklet is available from the U.S. Government Printing Office, Washington D.C. 20402, Stock # 004-000-00345-4.

IMPORTANT INFORMATION

This equipment complies with Part 68 of the FCC Rules and, if the product was approved July 23, 2001 or later, the requirements adopted by the ACTA. On the side of this equipment is a label that contains, among other information, a product identifier. If requested, this number must be provided to the Telephone Company.

Product Identifier US:F53AL01BPC1404 USOC Jack:RJ-31X

Telephone Connection Requirements

A plug and jack used to connect this equipment to the premises wiring and telephone network must comply with the applicable FCC Part 68 rules and requirements adopted by the ACTA. A compliant telephone cord and modular plug is provided with this product. It is designed to be connected to a compatible modular jack that is also compliant. See installation instructions for details.

Ringer Equivalence Number (REN)

The REN is used to determine the number of devices that may be connected to a telephone line. Excessive RENs on a telephone line may result in the devices not ringing in response to an incoming call. In most but not all areas, the sum of RENs should not exceed five (5.0). To be certain of the number of devices that may be connected to a line, as determined by the total RENs, contact the local Telephone Company. For products approved after July 23, 2001, the REN for this product is part of the product identifier that has the format US:AAEQ##TXXXX. The digits represented by ## are the REN without a decimal point (e.g., 03 is a REN of 0.3). For earlier products, the REN is separately shown on the label.

REN = 0.1B

Incidence of Harm

If this equipment (PC1404) causes harm to the telephone network, the telephone company will notify you in advance that temporary discontinuance of service may be required. But if advance notice is not practical, the telephone company will notify the customer as soon as possible. Also, you will be advised of your right to file a complaint with the FCC if you believe it is necessary.

Changes in Telephone Company Equipment or Facilities

The Telephone Company may make changes in its facilities, equipment, operations or procedures that could affect the operation of the equipment. If this happens the Telephone Company

will provide advance notice in order for you to make necessary modifications to maintain uninterrupted service.

Equipment Maintenance Facility

If trouble is experienced with this equipment (PC1404) for repair or warranty information, contact the facility indicated below. If the equipment is causing harm to the telephone network, the Telephone Company may request that you disconnect the equipment until the problem is solved. This equipment is of a type that is not intended to be repaired by the end user.

DSC c/o APL Logistics 757 Douglas Hill Rd., Lithia Springs, GA 30122

Additional Information

Connection to party line service is subject to state tariffs. Contact the state public utility commission, public service commission or corporation commission for information.

Alarm dialing equipment must be able to seize the telephone line and place a call in an emergency situation. It must be able to do this even if other equipment (telephone, answering system, computer modem, etc.) already has the telephone line in use. To do so, alarm dialing equipment must be connected to a properly installed RJ-31X jack that is electrically in series with and ahead of all other equipment attached to the same telephone line. Proper installation is depicted in the figure below. If you have any questions concerning these instructions, you should consult your telephone company or a qualified installer about installing the RJ-31X jack and alarm dialing equipment for you.

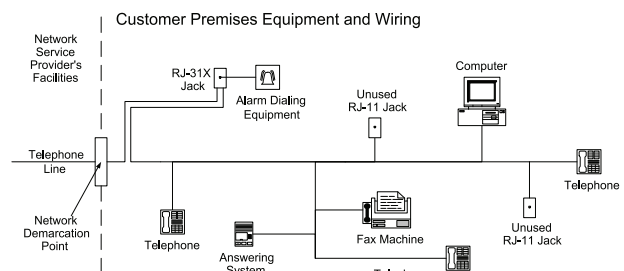

INDUSTRY CANADA STATEMENT

NOTICE: This product meets the applicable Industry Canada technical specifications. Le présent matériel est conforme aux spécifications techniques applicables d'Industrie Canada.

The Ringer Equivalence Number (REN) for this terminal equipment is 0.1. L'indice d'équivalence de la sonnerie (IES) du présent matériel est de 0.1.

The Ringer Equivalence Number is an indication of the maximum number of devices allowed to be connected to a telephone interface. The termination on an interface may consist of any combination of devices subject only to the requirement that the sum of the RENs of all the devices does not exceed five.

L'indice d'équivalence de la sonnerie (IES) sert à indiquer le nombre maximal de terminaux qui peuvent être raccordés à une interface téléphonique. La terminaison d'une interface peut consister en une combinaison quelconque de dispositifs, à la seule condition que la somme d'indices d'équivalence de la sonnerie de tous les dispositifs n'excède pas 5.

The term "IC:" before the radio certification number only signifies that Industry Canada technical specifications were met.

Certification Number:

IC:160A-PC1404

This Class B digital apparatus complies with Canadian ICES-003.

Cet appareil numérique de la classe B est conforme à la norme NMB-003 du Canada.

Europe



This product is in conformity with:

EMC Directive 2004/108/EC based on results using harmonized standards in accordance with article 10(5),

R&TTE Directive 1999/5/EC based on following Annex III of the directive and

LVD Directive 2006/95/EC based on results using harmonized standards.

The product is labelled with the CE mark as proof of compliance with the above mentioned European Directives. Also a CE declaration of conformity (DoC) for this product can be found at www.dsc.com under Agency Listings section.

Hereby, DSC, declares that this device is in compliance with the essential requirements and other relevant provisions of Directive 1999/5/EC. The complete R&TTE Declaration of Conformity can be found at http://www.dsc.com/listings_index.aspx

(CZE) DSC jako výrobce prohlašuje, že tento výrobek je v souladu se všemi relevantními požadavky směrnice 1999/5/EC.

(DAN) DSC erklærer herved at denne komponenten overholder alle vigtige krav samt andre bestemmelser gitt i direktiv 1999/5/EC.

(DUT) Hierbij verklaart DSC dat dit toestel in overeenstemming is met de eisen en bepalingen van richtlijn 1999/5/EC.

(FIN) DSC vakuuttaa laitteen täyttävän direktiivin 1999/5/EC olennaiset vaatimukset.

(FRE) Par la présente, DSC déclare que ce dispositif est conforme aux exigences essentielles et autres stipulations pertinentes de la Directive 1999/5/EC.

(GER) Hierdurch erklärt DSC, daß dieses Gerät den erforderlichen Bedingungen und Voraussetzungen der Richtlinie 1999/5/EC entspricht.

(GRE) Δια του παρόντος, η DSC, δηλώνει ότι αυτή η συσκευή είναι σύμφωνη με τις ουσιαστικές απαιτήσεις και με όλες τις άλλες σχετικές αναφορές της Οδηγίας 1999/5/EC.

(ITA) Con la presente la Digital Security Controls dichiara che questo prodotto è conforme ai requisiti essenziali ed altre disposizioni rilevanti relative alla Direttiva 1999/05/CE.

(NOR) DSC erklærer at denne enheten er i samsvar med de grunnleggende krav og øvrige relevante krav i direktiv 1999/5/EF.

(POL) DSC oświadcza, że urządzenie jest w zgodności z zasadniczymi wymaganiami oraz pozostałymi stosownymi postanowieniami Dyrektywy 1999/5/WE.

(POR) Por este meio, a DSC, declara que este equipamento está em conformidade com os requisitos essenciais e outras determinações relevantes da Directiva 1999/5/EC.

(SPA) Por la presente, DSC, declara que este equipo está en conformidad con los requisitos esenciales y otros requisitos relevantes de la Directiva 1999/5/EC.

(SWE) DSC bekräftar härmed att denna apparat uppfyller de väsentliga kraven och andra relevanta bestämmelser i Direktivet 1999/5/EC.

© 2012 Tyco International Ltd. and its Respective Companies. All Rights Reserved.

The trademarks, logos, and service marks displayed on this document are registered in the United States [or other countries]. Any misuse of the trademarks is strictly prohibited and Tyco International Ltd. will aggressively enforce its intellectual property rights to the fullest extent of the law, including pursuit of criminal prosecution wherever necessary. All trademarks not owned by Tyco International Ltd. are the property of their respective owners, and are used with permission or allowed under applicable laws.

Product offerings and specifications are subject to change without notice. Actual products may vary from photos. Not all products include all features. Availability varies by region; contact your sales representative.

DSC

A Tyco International Company

Technical Support: 1-800-387-3630 (Can/US)
905-760-3000 (Intl.) www.dsc.com
Printed in Canada



29008013R002