

FC501

**Addressable
Fire
Control Panels**



Installation Manual

This Fire Control panel can only be programmed using the Software **FireClass** Console release 1.0 or higher. Control panel FW ver. 1.0 or higher.

TYCO and BENTEL SECURITYsrl shall not assume the responsibility for damage arising from improper application or use.

Installation of this Control panel must be carried out strictly in accordance with the instructions described in this manual and in compliance with the local laws and bylaws in force.

The **FC501** Fire Control panels comply with the essential requirements of standards **EN54-2; EN54-4 and EN54-21**.

Contents of the box and Unpacking

The control panel is contained in a carton box, inside which are located:

- the plastic cabinet (backplate and cover) with the motherboard and the power supply Switching assembled.
- The Quick Start Guide.
- A transparent plastic bag inside:
 - A CD-ROM with Installation and User manuals and the FireClass software console to manage the panel;
 - Another transparent plastic bag containing:
 - the KST thermal Probe;
 - Two 3.9 kOhm resistors;
 - a red and a black cable L = 300 mm with a faston terminal to connect batteries;
 - a black cable L = 300 mm with two faston terminal to connect batteries. Proceed carefully to unpack the contents and dispose of recyclable materials in accordance with the local law.

Recycling information

The manufacturer recommends that customers dispose of their used equipment (panels, detectors, sirens, and other devices) in an environmentally sound manner. Potential methods include reuse of parts or whole products and recycling of products, components, and/or materials.

Waste Electrical and Electronic Equipment (WEEE) Directive



In the European Union, this label indicates that this product should NOT be disposed of with household waste. It should be deposited at an appropriate facility to enable recovery and recycling.

NOTE- The FC501 Fire control panel can support several addressable devices (Detectors, Modules, Manual call Points, etc). The present manual includes the instructions for their programming, but for further information on those devices and their accessories, please visit: www.fireclass.net, logging in the **Reserved Area**, under **Installation Manuals**.

The manufacturer reserves the right to change the technical specifications of these products without prior notice.

 0051	
BENTEL SECURITY s.r.l. Via Gabbiano, 22 - Zona Ind. S. Scolastica 64013 Corropoli (TE) - ITALY 13 0051-CPD-0406 (FC501-L) 0051-CPD-0407 (FC501-H)	
EN 54-2:1997+A1:2006 EN 54-21 Control and indicating equipment for fire detection and fire alarm systems for buildings with alarm transmission and fault warning routing equipment.	
EXPECTED OPTIONS Fault signals from points Dependencies on more than one alarm signal: type A and B Delays to outputs Disablement of addressable point Test condition Output to fire alarm device	
EN 54-2 ESSENTIAL CHARACTERISTICS	
Performance under fire conditions	Passed
Response delay (response time to fire)	Passed
Operational reliability	Passed
Durability of operational reliability, Temperature resistance	Passed
Durability of operational reliability, Vibration resistance	Passed
Durability of operational reliability, Electrical stability	Passed
Durability of operational reliability, humidity resistance	Passed
EN 54-21 ESSENTIAL CHARACTERISTICS	
Performance of transmission	Passed
Operational reliability	Passed
Durability of operational reliability, Temperature resistance	Passed
Durability of operational reliability, Vibration resistance	Passed
Durability of operational reliability, Electrical stability	Passed
Durability of operational reliability, humidity resistance	Passed
EN 54-4 ESSENTIAL CHARACTERISTICS	
Performance of power supply	Passed
Operational reliability	Passed
Durability of operational reliability, Temperature resistance	Passed
Durability of operational reliability, Vibration resistance	Passed
Durability of operational reliability, Electrical stability	Passed
Durability of operational reliability, humidity resistance	Passed

 0051	
BENTEL SECURITY s.r.l. Via Gabbiano, 22 - Zona Ind. S. Scolastica 64013 Corropoli (TE) - ITALY 13 0051-CPD-0408 (FC500IP in FC501-L/FC501-H)	
EN 54-21 Alarm transmission and fault warning routing equipment for fire alarm systems installed in buildings.	
EN 54-21 ESSENTIAL CHARACTERISTICS	
Performance of transmission	Passed
Operational reliability	Passed
Durability of operational reliability, Temperature resistance	Passed
Durability of operational reliability, Vibration resistance	Passed
Durability of operational reliability, Electrical stability	Passed
Durability of operational reliability, humidity resistance	Passed

TABLE of CONTENTS

INTRODUCTION	5	PC PROGRAMMING	29
FC501 Fire Control Panel	5	Installation	29
<i>Accessory Items</i>	5	Select language	29
Description	5	Software window Look	29
<i>Input</i>	5	Control panel connections	29
<i>Outputs</i>	5	Main window	29
<i>Operating Features</i>	6	<i>Icons description</i>	30
<i>Interface</i>	8	<i>File menu</i>	30
<i>Access to Signalling and Commands</i>	9	<i>Tools menu</i>	30
<i>Users and Installers Features</i>	9	Panel Details	30
<i>Power Supply</i>	9	<i>Panel Details Menu</i>	31
Description of the FC500REP Repeater Signalling	10	<i>Communication Menu</i>	31
<i>FC500REP Repeater Control keys</i>	10	<i>Language Menu</i>	31
<i>FC500REP Repeater LED description</i>	10	<i>Firmware Update menu</i>	31
Description of the Control keys (Panel)	11	<i>ScreenSaver menu</i>	31
The status LED	12	<i>Account Menu</i>	31
		<i>Help Menu</i>	32
		Programming Pages	32
PARTS IDENTIFICATION	13	Loop Devices programming	32
Description of Parts	14	<i>Description of the icons in the tool bar.</i>	32
		<i>Loop wiring Calculation</i>	33
INSTALLATION	17	<i>Detectors parameters programming</i>	33
Installing the Control panel	17	<i>Input module parameters programming</i>	34
<i>Control panel closure</i>	17	<i>Output module parameters programming</i>	34
Installing FC500REP Repeater	17	<i>Multiple Input-Output Module - Parameters</i>	34
Description of the Terminals	19	<i>Programming (FC410MIO/FC410QIO)</i>	34
<i>Loop</i>	19	<i>Manual Call Point parameters programming</i>	34
<i>Telephone line</i>	19	Zones programming	35
<i>Fire</i>	19	Outputs Programming	35
<i>Fault</i>	19	<i>SC1, SC2 Outputs</i>	35
<i>Audio station</i>	20	<i>OC1, OC2 Outputs</i>	36
<i>Auxiliary outputs</i>	21	<i>Relay Outputs</i>	36
<i>RS485</i>	22	General Options programming	36
<i>Battery</i>	22	Communicators Programming	37
The System Wiring	22	CLOCK	40
<i>Connecting Addressable Devices</i>	22	LOG	40
<i>Connecting Repeater FC500REP</i>	23	UTILITIES	40
<i>Connecting Output Devices</i>	23	<i>Battery Calculation</i>	40
<i>Bell Outputs</i>	23	User mode	40
Connecting the Power Supply	23		
<i>Thermal Probe</i>	24		
Installing FC500IP board	25		
Installing the 38Ah battery metal Box	26		
Maintenance	28		

PROGRAMMING FROM THE PANEL	43
Using the system	43
Operating the system from the Panel	43
Alphanumeric entry (<i>Editing text</i>)	43
Assistant text composition	43
Single Selection	44
Multiple Selection	44
Date and Time	44
Numeric entry	44
Main Page - Accessing the system	45
Insert password	45
Programming Page	46
0 KEY - insert Modify password	46
1 KEY- Auto Enrolling (Autolearning)	46
Automatic zones assignment	47
Warning Enrolling (Autolearning)	47
Auto addressing procedure	48
2 KEY -Device	49
Choose the Loop (<i>see User Manual View Devices</i>)	49
Choose the Device	50
Loop devices programming page	50
3 KEY - SW zone	50
SW zone in WALK TEST	50
Detector alarm verification (<i>Smoke delay</i>)	51
Prealarm	51
4 KEY- OUTPUT	51
Choose Output	51
SC on disablements	52
5 Key- Network	52
6 KEY - MAP DEVICE	52
7 KEY -USB	53
8 KEY -SYSTEM	53
Panel ID	54
Day / Night / Auto	54
Pre-alarm time	54
Copy on Zone?	54
9 KEY- Restore Default	54
FC500REP Repeater Address from the Repeater panel ONLY	54
<hr/>	
QUICK START-UP PROCEDURE	55
PROCEDURE	55
System default	58
Zone assignment	58
System default parameters	58

ACCESSORY	61
FC500IP - IP Module	61
4B - Universal Base	61
FC460H or FC400H-Addressable Heat Detector	61
FC460P or FC400P - Addressable Optical Smoke	61
FC460PH or FC400PH - Addressable Optical Smoke & Heat Detector	61
FC460PC Addressable Optical Smoke & Heat Detector & CO	62
FC410LI - Line Isolator Module	62
FC410MIM - Mini Input Module	62
FC410MIO - Small Addressable Multi I/O Module	62
FC410SIO - Single Input/Output Module	62
FC420CP - Addressable Break Glass Callpoint (indoor)	62
FC421CP - Addressable Break Glass Callpoint (outdoor)	62
FC430SAB/SAM - Sounder Base Address Modules	62
FC430SB - Loop Low Power Sounder Base	62
FC450IB - Isolator Base	62
FC490ST - Loop Service Tool	63
FC410BDM - Beam Detector Module	63
FC410CIM - Contact Input Module	63
FC410DIM - Detector Input Module	63
FC410RIM - Relay Interface Module	63
FC400CH - Addressable Carbon Monoxide + Heat Detector	63
801RIL - Remote LED Indicator	63
801HL - Remote LED Indicator	63
HVR800-High Voltage Relay	63
MP69-Duct Probe Unit	64
FIRERAY 50/100-Optical Beam Smoke Detector	64
FC410LPSY and FC410LPAV loop powered sounders and sounder-beacons	64
FC430LPSB and FC430LPASB Loop Powered Addressable Sounder/Beacon Base	64
FC410SNM Sounder Notification Module	64
FC410TSM – door control module	64
FC410DDM – Universal fire and gas detector module	64
FC410QIO Quad input output module	65
FC410QRM Quad relay module	65
FC410QMO Quad Monitored Output Module	65
<hr/>	
SPECIFICATIONS	66
Technical features	66
Description of the terminals	66
Table of distribution of currents	67

FC501 Fire Control Panel

The FC501 Fire panel series has been designed and manufactured to the highest standards of quality and performance adopted by Bentel Security.

The FC501 Fire panel series is available in the following models:

- **FC501-L:** Analogue addressable Fire Control Panel with **3 Loops**, that can support up to **128** addressable device and 32 zones.
Powered: BENTEL **BAQ35T24** Switching Power Supply (1.5A @ 27,6V).
Suitable batteries: 2 * 12 V/ 7Ah
2 * 12 V/ 12Ah.
- **FC501-H:** Analogue addressable Fire Control Panel with **3 Loops**, that can support up to **128** addressable device and 32 zones.
Powered: BENTEL **BAQ60T24** Switching Power Supply (2.5 A @ 27.6V).
Suitable batteries: 2 * 12 V/ 12Ah
2 * 12 V/ 38Ah.

 *In this manual the term FC501 is used to describe the characteristics common to all versions while the version name is used to describe the differences between the versions listed above*

 *The components of these Control panels operate as intended when the external ambient conditions comply with the requirements of class EN 60721-3-3:1995.*

The FC501 control panel has a 4-line, 40 characters per line LCD module with a backlight, which provides written information regarding the system status and for programming the control panel.

■ Accessory Items

FC500REP This Repeater panel is intended for connection (via 4 wires) to **FC501** Control panels. It provides all the visual and audible warnings generated by the Control panel and allows end-users to manage the system from a remote location (up to 1000 m, with double twist shielded cable).

The **FC501** Control panels can support up to 4 **FC500REP** Repeater panels.

FireClass Console This user-friendly software application (Microsoft Windows XP & above) offers a quick and easy way to program the Control panel and provides event log functions.

Description

■ Input

The 3 Loops manage up to 128 devices.

■ Outputs

This section describes how the Control panel outputs operate.

Supervised outputs The Control panel will be able to detect and signal short-circuits and power supply interruptions on this type of output.

Bypassable(Disabled) outputs The user will be able to disable (by means of the respective key) this type of output.

Silenceable outputs The user will be able to stop (via the **Silence/Resound Sounders** key)  this type of output.

The outputs can be silenced for an indefinite period (during Day Mode), or for the programmed Silence Time (during Night Mode).

■ Operating Features

Warning The FC501 control panel can be programmed to provide WARNINGS or PREALARMS status before ALARM status.

This status will be signalled by the WARNING display. The panel will generate a warning when an input point (detector) exceeds its warning threshold and there is risk of an alarm.

-WARNING STATUS will be signalled by:



- control panel buzzer (2 sec. of sound at 440 Hz and then 2 sec. of pause)
- a WARNING message on LCD display
- the WARNING output points if the **Pre-alarm** option is enabled;



Pre-alarm If a zone generates an alarm during Day Mode, the Control panel will start the **Pre-alarm Time**. This status will be signalled by:

- control panel buzzer (0,5 sec. of sound at 880 Hz and then 0,5 sec. of pause);
- Blinking on the **Pre-al.** LED (for the first 8 zones only);
- Message ALARM+DLY on LCD display;
- Activation of respective outputs, if the **Pre-alarm** option is enabled;

 *This Control panel will generate an Instant Alarm if alarm conditions are detected during **Night Mode** or if an alarm is triggered from a Callpoint.*

During Pre-alarm status, you will be able to (see Access to Signalling and Commands):

- **Access Level L1** activate an Evacuation Alarm by pressing and holding the **Evacuate** Key ()
- **Access Level L2** stop the Silenceable outputs and interrupt the Pre-alarm Time by pressing the **Silence** key ()



During **Silence** status ( **Silence** LED glowing), it is possible to use the  **Silence** key to release the **Silenceable** outputs, or use the () **Reset** key to restore standby status.

 *If the Control panel is operating in Night Mode, the Control panel will exit from **Silence** status automatically when the programmed **Silence Time** expires*

Alarm The Control panel will generate an alarm when the **Pre-Alarm Time** expires. Alarm status will be signalled by:

- control panel buzzer (0,2 sec. of sound at 3300 Hz and then 0,2 sec. of pause);
- glowing of the Alarm LED ()
- an alarm message on LCD display;
- activation of the **FIRE** and **SC1** outputs;
- activation of other outputs SC2, OC1 or OC2 if programmed.

During Alarm status, (see Access to Signalling and Commands) it is possible:

- **Access Level 2** stop the Silenceable outputs by pressing the **Silence** key ()
- **Access Level 2** press the **Reset** key () and Silence Buzzer ()

During **Silence** status (**Silence** LED glowing), it is possible to use the **Silence** key to release the **Silenceable** outputs, and the **Reset** key to restore standby status.

 *If the Control panel is in Night Mode (**Day Mode** LED OFF), the Control panel will exit **Silence** status when the programmed **Night mode Silence time** expires*

Day/Night Mode The control panel can operate in DAY or NIGHT Mode. See "PC PROGRAMMING" chapter.

If the system is silenced during DAY Mode, SILENCE status will be held until the system is unsilenced (i.e. unless new alarms occurs). If the system is silenced during NIGHT Mode, SILENCE status will be held until the Night Mode Silence time expires.

On power up (at default) the system will set to DAY Mode. During this operating mode, silenced alarms/fauls will not be unsilenced automatically until the Night Mode Silence time expires.

Fault This Control panel can detect and signal the Fauls shown in the Table n.1:

Fault conditions will be signalled by:

- control panel buzzer (1 sec. of sound at 660 Hz and then 1 sec. of pause);
- glowing on the **Fault** LED () and on relative Fault LED;
- a **Fault** message on LCD display;
- activation of the **Fault** output;
- activation of other outputs **SC2**, **OC1** or **OC2** if programmed.

The **Fault** output and any additional programmed fault outputs (if correctly programmed by Installer) will restore to standby automatically when fault conditions clear. Under certain circumstances, fault conditions may clear spontaneously, if this occurs, the event will be stored in the memory until the Control panel Resets.

Stored Fault events will be signalled by:

- **slow blinking** on the Fault LED ()

Silence This Control panel provides a **Silence** key () which can be used to restore the Silenceable outputs to standby status.

Silence status will be signalled by:

- glowing on the **Silence** LED ()

Silence status will be held until the **Silence** key () is pressed again or, if the Control panel is operating in **Night Mode**, until the programmed **Night mode Silence time** expires, or until a new Alarm condition is detected.

Message	Problem
Switching 1	<i>Switching power supply 1 Fault</i>
Mains fault	<i>The Control panel is NOT powered from the Mains</i>
Battery	<i>The Control panel batteries charger not working properly</i>
Low battery	<i>The Control panel batteries are empty</i>
Earth	<i>Leakage to Earth</i>
24A Output	<i>24A Output is shorted</i>
24R Output	<i>24R Output is shorted</i>
Flash writing	<i>Flash writing error</i>
Flash erasing	<i>LOG erasing error</i>
Main controller	<i>Main controller fault</i>
Firmware main contr.	<i>Checksum fault</i>
Prog.data main cont	<i>Data programming Checksum fault</i>
Prog.data tel.board	<i>Aux Controller data programming Checksum fault</i>
Loop Communication	<i>Communication Loop fault controller</i>
Not programmed dev	<i>Loop device without address</i>
Loop return open	<i>Loop negative signal open</i>
Loop signal open	<i>Loop positive signal open</i>
Loop local short	<i>Local short on Loop controller</i>
Loop right short	<i>Right side Loop short</i>
Loop left short	<i>Left side Loop short</i>
Non answer	<i>Loop device doesn' t answer</i>
Dirty level	<i>(Smoke detector ONLY) the dirty threshold has been exceeded</i>
Short circuit	<i>Short circuit on Input module</i>
Open circuit	<i>Open circuit on Input module</i>
Power supply	<i>Main fault</i>
Wrong value	<i>A Loop device has a wrong value</i>
Stuck output	<i>An Output module relay is not switched</i>
Same address	<i>Several Loop devices have the same address</i>
Wrong Type	<i>Different loop device from that programmed in the panel</i>
IP Communicator	<i>The communication with IP controller is lost</i>
IP receiver	<i>The communication with IP receiver is lost</i>
Display communic.	<i>Communication fault on Display controller</i>
PSTN communicator	<i>The communication with PSTN controller is lost</i>
Telephone line	<i>Telephone Line fault</i>
LOG Full	<i>LOG fault</i>
Backup PSTN line	<i>Backup Telephone Line fault</i>
PSTN Action not Ack.	<i>A PSTN action has not been acknowledged</i>
SC x short	<i>SC x= (1 or 2) short circuit</i>
SC X open	<i>SC x (1 or 2) open terminal</i>
Transistor SC x	<i>Transistor SC x (1 or 2) fault</i>

Table 1 *Faults table (Continued..)*

Message	Problem
LOOP x NOISY	The devices on the loop x (1, 2 or 3) don't communicate properly with the panel (Check the quality of wiring)
PERIODIC TEST D	The digital call for periodic test has failed
PERIODIC TEST V	The vocal call for periodic test has failed
REPEATER COMMUNIC.	A repeater on the RS485 does not respond
MFI x COMMUNIC.	(x from 1 to 4)
PRINTER x FAULT	(x from 1 to 4)
PRINTER x ABSENT	(x from 1 to 4)
MFI x SERIAL CHANN.	(x from 1 to 4)
MFI x RADIO LINK	(x from 1 to 4)
MFI x RADIO PATH	(x from 1 to 4)
MFI x INy SHORT	(x from 1 to 4; y from 1 to 5)
DEFAULT DATA	The fire panel resets to default data

Table 1 Faults Table

 The Silenceable outputs can only be manually silenced at access level 2 or 3.

Disabled This Control panel can disable:

- the devices on the Loop, SC2 Output, OC1 and OC2 outputs, the software zones, the RS485 network devices (FC500MFI).
- DISABLED zones cannot generate alarms or warnings of any kind, and DISABLED outputs cannot be activated.

Disabled status will be signalled by:

- glowing on the **Disabled** LED ();

 The DISABLE facility is only available at access level 2 or 3.

Reset Resetting the Control panel will restore the outputs to standby status, clear the memory, and interrupt the power supply to terminals 24R.

 The panel can only be Reset at access level 2 or 3

■ Interface

Visual Signalling The system status will be signalled on the Control panel LEDs as follows:

GREEN indicates normal operating conditions;
AMBER indicates specific operating modes (for example Day or Night mode), and/or Fault conditions;
RED indicates Alarm conditions.

Memory The Control panel will signal Fault events (FAULT LED blinking ) until the system Resets, even if the event clears in the meantime.

Audible Signalling The Buzzer will signal the Control panel status as in the following table 2:

 When an alarm is silenced and a new fault is detected, the control panel will resound the previously silenced alarm.

Test **LAMP TEST** () key will allow ALL users to test the Control panel Buzzer and LEDs.

Status	Sound	Pause	Frequency
SYSTEM FAULT (main processor fail)	2.5 s	2.8 s	1300 Hz
SYSTEM FAULT (Programming data corrupted)	1 s	1 s	660 Hz
Warning	2 s	2 s	440 Hz
Delay to Alarm (Prealarm)	0,5 s	0,5 s	880 Hz
Alarm	0,2 s	0,2 s	3300 Hz
Fault	1 s	1 s	660 Hz

Table 2 Buzzer signalling

■ Access to Signalling and Commands

There are 4 access levels, in compliance with the Fire Safety Regulations in force.

Access Level1 (L1) Viewing: **ALL** persons can view the Control panel status (No Password requested).

Access Level 2 (L2) Operating the system (PIN Code entered): Password Code Users can operate the system (User level).

Access Level 3 (L3) Programming and Opening the Control panel (Password Code entered): **ONLY Qualified persons with authorization** are allowed to open the Control panel door (requires removal of the Cover screws) for maintenance purposes or to replace batteries. (Installer Level).

Access Level 4 Repairing or replacing the PCB: **ONLY the Manufacturer** should be allowed to repair or replace the PCB, (requires removal of the Cover screws).

■ Users and Installers Features

The panel will be able to recognize and manage up to 8 different users and 2 different installers. At each login of any users will be logged the login event with the ID of the user. At each login of any installers will be logged the login event with the ID of the installer. It will also log the return to access level 1 of the panel to indicate the end of the user or installer session.

In the following the default Password for the eight Users.

USER #1	11111
USER #2	22222
USER #3	33333
USER #4	44444
USER #5	55555
USER #6	66666
USER #7	77777
USER #8	88888

In the following the default Password for the two Installers:

INSTALLER #1	00000
INSTALLER #2	99999.

By default only the USER #1 is working with its default password. All the other users are not available and not enabled. The USER #1 may not be disabled or made unavailable.

By default only the INSTALLER #1 is working with its default password. All the other installers are not available and not enabled. The INSTALLER #1 may not be disabled or made unavailable.

Only the INSTALLER #1, via Fireclass Console or panel User Interface, may modify the availability and enabling status of the USERS #2.... #8 and INSTALLER #2.

The INSTALLER #1, via Fireclass Console or panel User Interface, may modify the password value for the USERS #1.... #8 and INSTALLER #2.

 *Each Installer o each User can modify its own password.*

When the first password is entered via User Interface by INSTALLER #1 to a User/Installer, it will be declared as "available" and will be automatically enabled.

If the first installer lost the password, it is possible to enter a new password using the following procedure:

- open the fire panel after removing the two screws (access level 4) and remove the jumper J5 of the main board,
- access to the installer menu page,
- go to programming page of the installer password and enter the new password,
- now the new password is stored as the current INSTALLER #1, the user interface will return back to the MAIN page indicating an activity of local programming, followed by a panel reset,
- replace the J5 jumper to restore the normal program menu page functionality (see Figure 40 b).

■ Power Supply

The power supply system of the **FC501** Control panels complies with EN54-4.



All models are powered by the Mains (230V, 50 Hz):

- the **FC501-L** has Switching Power Supply which supplies up to 1.5 A at 27.6V;
- the **FC501-H** has Switching Power Supply which supplies up to 2.5 A at 27.6V;

All models can house two 12V batteries which, when connected in series, will supply 24V to the Control panel and peripherals in the event of black-out.

The **FC501-L** can house two 12V, 7Ah batteries (YUASA NP or 12V 12Ah FR model or similar — flame class UL94-V2 or higher).

 *If necessary, (full configured Loop or for particular requirements of the system) the FC501-H control panel can be connected to two 12V, 38 Ah batteries in an external metal box (see Figure 14).*

This Control panel can detect, signal and store in memory the following power faults: shorted 24A or 24R outputs; Low battery, Battery fault or Battery disconnected **Battery trouble LED** (), Ground fault **Earth LED** () and Mains failure **Power Supply Fault LED** ().

 *The “**Battery** or **Low Battery**” fault may be signalled with a delay up to 1 minute (see Table n.1). The “**Mains**” (Amber) fault will be signalled when the programmed delay expires.*

■ FC500REP Repeater Control keys

☞ **Test, Silence Buzzer and Evacuate** Control keys **ONLY** can be activated without password (access level L1), all the others Control keys can be activated with password (access level L2 and L3) (see table n.3).

LEDs	DESCRIPTION
FIRE	Glowing indicates Alarm status. In the event of an Alarm, the Control panel will activate the unbypassed alarm outputs.
More Alarms	Glowing indicates more Alarm status.
Pre-alarms	Blinking indicates Pre-alarm status.
Communicator (Red)	Glowing indicates that transmission was successful. Blinking indicates that transmission is in progress. The control panel display will show the connection type: PSTN, GSM, or LAN network.
FAULT	Glowing indicates the presence of a Fault: the following LEDs or the screen on the display indicate the type of the Fault. Slow blinking indicates a fault event in memory (Reset turns OFF).
Logic Unit	Glowing indicates a blocked Control panel. IMPORTANT: Maintenance required. NOTE – When the Control panel is switched on for the first time, this LED will blink until a Reset has been performed.
Lost Device	Glowing indicates that a Loop device has disappeared (missing address).
Communicator (Amber)	Glowing indicates the Dialer has been disabled; Slow blinking indicates that the dialer has broken down
(SC)Nac Fire Output	Glowing indicates that SC FIRE Output is bypassable (disabled), Slow blinking indicates the presence of a Fault on SC FIRE Output.
Earth	Glowing indicates a Voltage leakage to Earth. IMPORTANT: Check wiring insulation
Low Battery	Glowing indicates Batteries empty or faulty. If this condition persists, the batteries will be unable to function as intended in the event of blackout. IMPORTANT: New batteries required.
NO Battery	Glowing indicates Batteries empty or disconnected ; check if the connections are correct.
MAINS (amber)	Glowing indicates Mains failure (230 V) or Switching Power supply fault. During this condition, the Control panel will be powered by the batteries.
Day mode	Glowing indicates that the Control panel is operating in Day Mode OFF indicates that the Control panel is operating in Night Mode
Disabled	Glowing indicates the Disabled status of any bypassable entity.
Silence	Glowing indicates that Silenceable outputs have been forced to standby by means of SILENCE key; in Day Mode the SILENCE will remain until the SILENCE key will not be pressed again, while in Night Mode after the Silence Time expires automatically the SILENCE will end.
Test	Glowing indicates Test conditions on at least one zone.
MAINS (Green)	OFF indicates Mains failure (230 V). IMPORTANT: Power must be restored before the batteries empty.

Table 3 Description of the status LEDs

KEY	DESCRIPTION
Lamp/Buzz Test	This key can be used to test the buzzer and LEDs . If this key is pressed (when the Control panel is functioning as intended), all the LEDs will glow and the buzzer will emit a continuous beep.
Silence	This key can be used to restore the Silenceable outputs to standby status. Silence status will be held until the Silence key is pressed again in Day Mode, or if the Control panel is operating in Night Mode, until the Night mode Silence time expires or until a new Alarm/Trouble condition is detected.
Investigate	This key can be used to refresh the “PreAlarm Time”: if this key is pressed during “PreAlarm”, the remaining PreAlarm time will be increased with the programmed "Recognition delay".
Silence Buzzer	Key to silence the local buzzer of the control panel: the buzzer will be operating every time a new event will be activated
Reset	This key can be used to reset the Fire detectors and restore all outputs to standby status (Supervised/Silenceable outputs, NON-Supervised/Non-Silenceable outputs and Alarm zone outputs)
Evacuate	key to activate the evacuation: if this key is pressed for over 2 seconds, the system will generate an alarm.
F1, F2, F3, F4	Function keys of the Display; their function will be various according to different screen of display.

Table 5 Description of the FC500REP Control keys

Description of the Control keys (Panel)

 **Test, Silence Buzzer and Evacuate** Control keys ONLY can be activated without PIN (access level L1), all the others Control keys can be activated with PIN (access level L2 and L3)

Silence The **Silence** key is used to restore the Silenceable outputs to standby status. If the Control panel is operating in **Night Mode**, the **Silence** will be active until the programmed **Night mode Silence time** expires, or in **Day Mode** until the **Silence** key is pressed again. Both modes the **Silence** is automatically canceled whenever a new Alarm condition is detected.

Reset The **Reset** key is enabled only at Level L2 (PIN) as the fire panel returns to the Stand-by status after the Alarm, Prealarm, Warning and FAULT conditions will stop.

The system will reprocess, at the end of the **Reset time**, any alarm, prealarm, warning or fault signal which is not cleared by RESET operations.

 When **RESET** is running the command keys cannot be used.

 In the English User Interface version, the icons will not be present.







KEY	DESCRIPTION
 SILENCE/ RESOUND SOUNDERS	This key can be used to restore the Silenceable outputs, and the Loop devices to standby status. Silence status will be held until the Silence key is pressed again in Day Mode , or if the Control panel is operating in Night Mode , until the Night mode Silence time expires or until a new Alarm/Trouble condition is detected.
 RESET	This key can be used to reset the Fire detectors and restore all outputs to standby status.
 INVESTIGATION DELAY	This key can be used to refresh the “PreAlarm Time”: if this key is pressed during “PreAlarm”, the remaining PreAlarm time will be increased with the programmed “ Investigation delay ”.
 EVAC	key to activate the evacuation : if this key is pressed , the system will generate an alarm.
 SILENCE BUZZER	Key to silence the local buzzer of the control panel: the buzzer will be operating every time a new event will be activated.
 LAMP TEST	This key can be used to test the buzzer and LEDs . If this key is pressed (when the Control panel is functioning as intended), all the LEDs will glow and the buzzer will emit a continuous beep.

Table 4 Description of the Control keys Panel

 The reset of the Fire Panel can also be carried out by any repeaters FC500REP connected to the Panel: also in this case it is necessary to know a PIN to access the L2 level or higher.

For the **Evacuate, Lamp/Buzz/Test, Investigate, Silence Buzzer** keys, see table 4.

The status LED

The following section describes how the Control panel LEDs operate. During standby status, **ONLY** the **GREEN Mains LED** and the **Day mode LED** (if the control panel is in Day mode) should be On (glowing) .















LED		DESCRIPTION
	FIRE (Red)	Glowing indicates Alarm status. In the event of an Alarm, the Control panel will activate the unbypassed alarm outputs.
	GENERAL FAULT (Amber)	Glowing indicates the presence of a Fault: the following LEDs or the screen on the display indicates the type of the Fault. Slow blinking indicates a fault event in memory (Reset turns OFF)
	SYSTEM FAULT (Amber)	Glowing indicates a blocked Control Panel. IMPORTANT: Maintenance required. Slow blinking indicates the Control Panel restart Fast blinking indicates that the data panel programming is corrupted NOTE – When the Control panel is switched on for the first time, this LED will blink until a Reset has been performed.
	FIRE SIGNAL FAULT (Amber)	Glowing indicates the communicator has been disabled; Slow blinking indicates that the communicator has broken down
	POWER SUPPLY FAULT (Amber)	Glowing indicates Mains failure (230 V) ; Fast blinking indicates Switching Power supply fault. During this condition, the Control panel will be powered by the batteries.
	EARTH FAULT (Amber)	Glowing indicates a Voltage leakage to Earth. IMPORTANT: Check wiring insulation
	BATTERY TROUBLE (Amber)	Glowing indicates Batteries empty or faulty. If this condition persists, the batteries will be unable to function as intended in the event of blackout, IMPORTANT: New batteries required.
	POWER ON (Green)	Glowing indicates panel is supplied with power. OFF indicates Mains failure (both mains & battery power is lost) (Battery disconnect threshold: 19,2 V). Power must be restored before the batteries reach the disconnect threshold.
	MORE INFO (Amber)	Glowing indicates that there are hidden information with lower priority: access to the page View List to show the hidden information. OFF indicates No suppressed Info are available
	SOUNDERS SILENCED (Amber)	Glowing indicates that Silenceable outputs and Loop device have been forced to standby by means of SOUNDER SILENCED key; in Day Mode the SILENCE will remain until the SILENCE key will not been pressed again, while in Night Mode after the Silence Time expires automatically the SILENCE will end.
	FIRE SIGNAL ON (Red)	Glowing indicates that transmission was successful. Slow Blinking indicates that transmission is in progress. On display of control panel it is possible to know the connection type: PSTN, GSM, or LAN network.
	SOUNDERS FAULTS/DIS	Glowing indicates that SC 1 Output is disabled or SC2 "act as SC1" is disabled, Slow blinking indicates that SC1 is in fault or SC2 "act as SC1" is in fault. OFF indicates all the SC outputs function properly.
	DISABLED	Glowing indicates the Disabled status of any bypassable entity.
	TEST	Glowing indicates Test conditions on at least one zone.
	DAY MODE	Glowing indicates that the Control panel is operating in DAY MODE OFF indicates that the Control panel is operating in NIGHT MODE
1-8	SOFTWARE ZONES RED	Glowing indicates that the corresponding Software zones is in Alarm status Slow Blinking indicates that the corresponding Software zones is in Pre-Alarm status.
N/D	CONTROLS ON (AMBER)	Glowing indicates that the Control Panel is at least at level 2 so the Silence/Resound Sounders, Reset and Investigation Delay Keys are enabled

Table 6 Description of the status LEDs

PARTS IDENTIFICATION

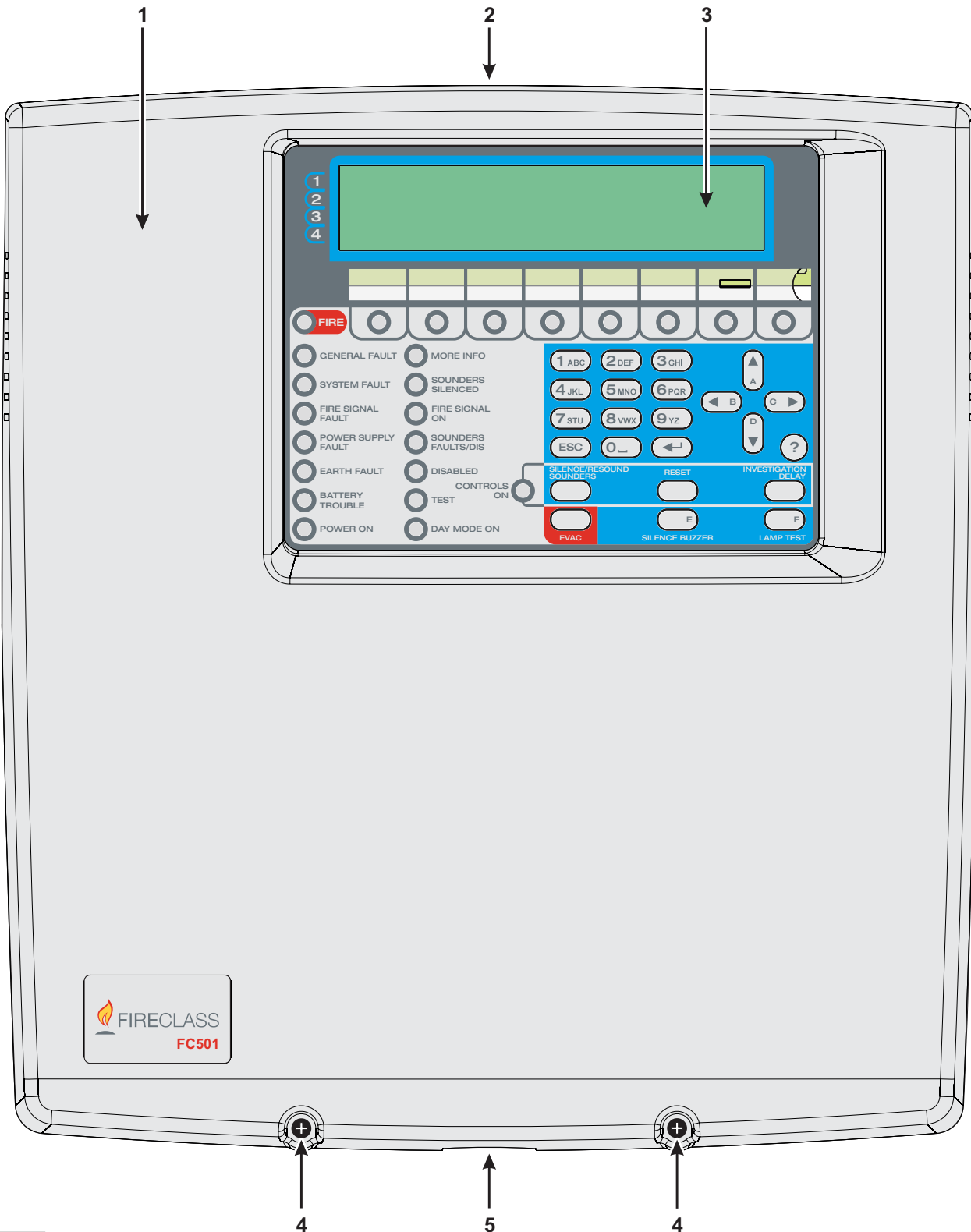

Figure 1 FC501 Parts: external view

Description of Parts

This section describes the components of the FC501 Control panels.

Unless otherwise stated, the numbers in boldface in this Manual refer to the Tables and Diagrams in this section.

P.	Description
1	FC501 cover
2	Knockouts for cables ducted externally
3	Display
4	Screws (2) to close the Cover on Backplate
5	Knockout for connection FC501-H Panel with FC500BX battery cabinet (accessory item)
6	Hooks to secure the cover on the backplate
7	Backplate anchor screw locations

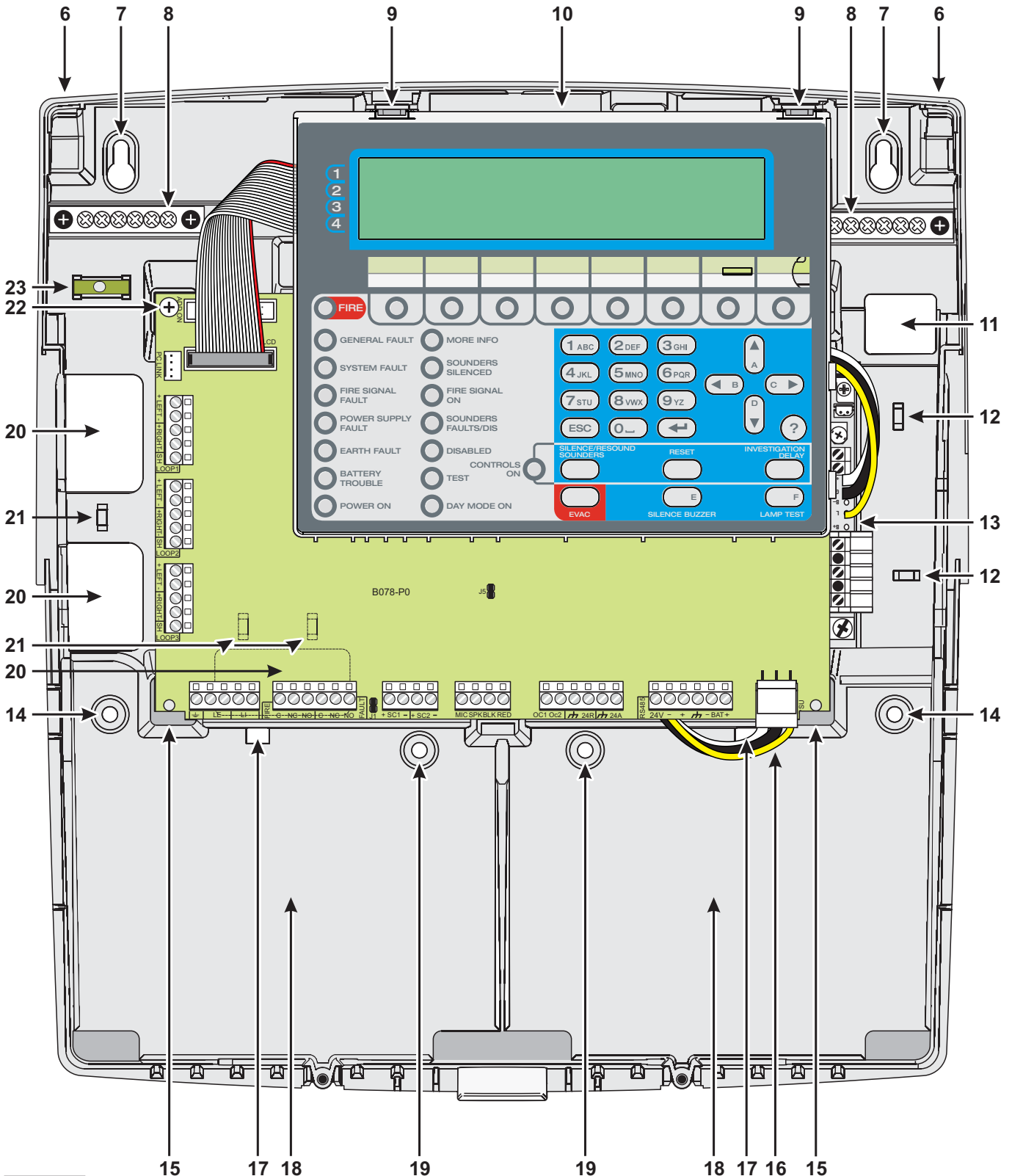



Figure 2 FC501 parts, internal view.

P.	Description
8	Terminals (2) for the earth connection wires
9	Hooks (2) to secure Main module on the backplate
10	Main Module (see figure 3)
11	Cable entry for channeled undertrack cables: power cable
12	Anchors (2) for power cable
13	Switching power supply (see figure 4)
14	Backplate anchor screw locations
15	Main module supports (2)
16	Power cable for Main module
17	Opening (2) to secure batteries
18	Location for 2 batteries 12V, 7Ah or 12Ah
19	Backplate auxiliary anchor screw locations (2)
20	Cable entry (3) for channeled undertrack cables
21	Cables anchor (3)
22	Screw to secure main module
23	Tubular spirit level
24	Connector for FC500IP Module
25	Opening to insert the zone location text strip
26	USB port

P.	Description
27	Power supply main module connector
28	RS485 Serial port & battery connection terminals
29	Programmable outputs and auxiliary power supply terminals
30	Buzzer (not visible)
31	Terminals for future use
32	Jumper J5 to reset the installer PIN n. 1 to the factory default (0000)
33	SC outputs
34	Jumper for the exclusion of the Earth Fault:  = Earth Fault detected (Default);  = Earth Fault ignored
35	FIRE and FAULT relay outputs
36	Terminals for phone line connection
37	Loop1
38	Loop2
39	Loop3
40	RS232 Serial (PC link)
41	Hole for Main module fixing

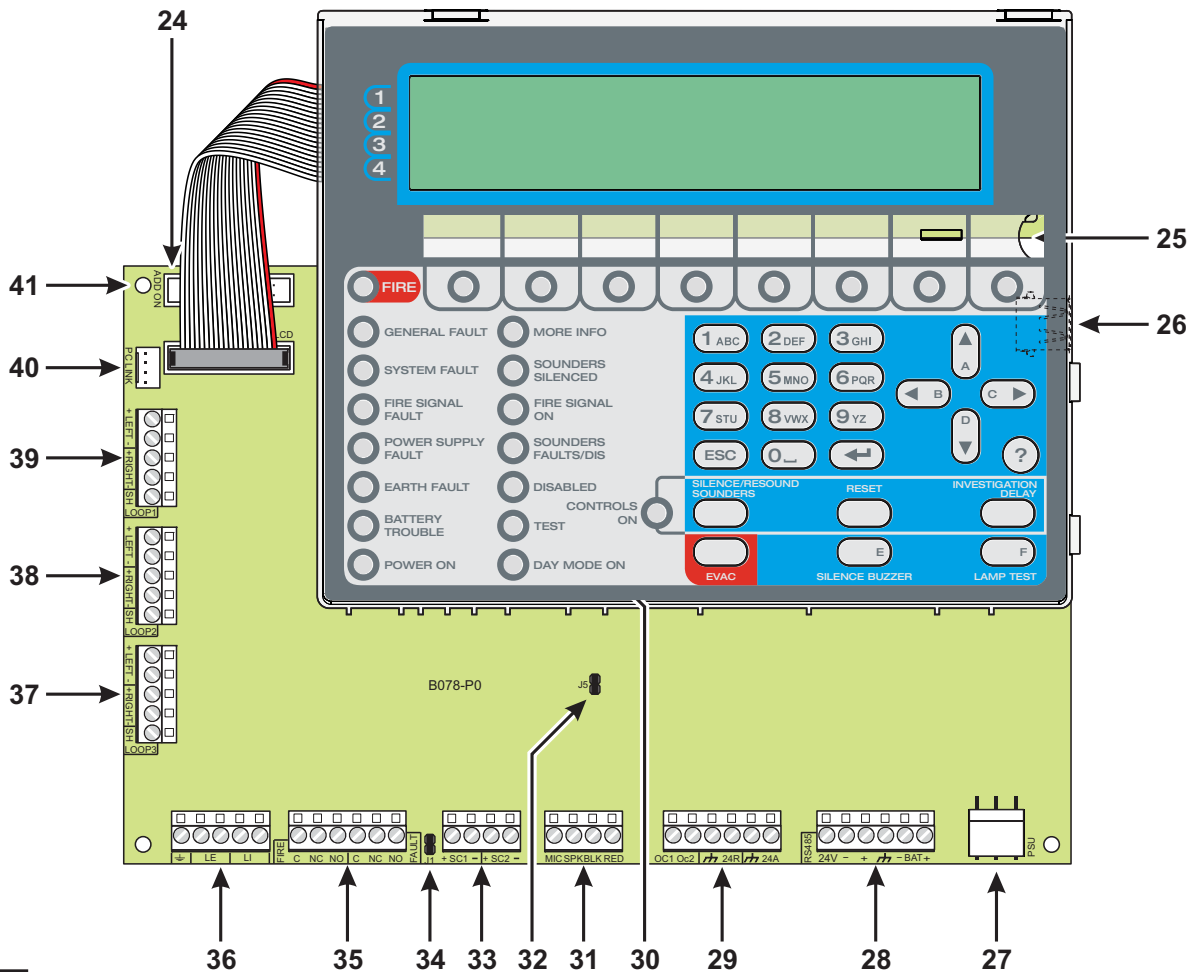

Figure 3 Main module Parts

P.	Description
42	Protection Fuse: F 6.3A 250V
43	Main Power LED
44	Hole for switching Power supply fixing
45	Thermal probe connector
46	Fine trimmer for the Switching-power-supply output Voltage
47	Auxiliary power-supply terminals (27.6 V)
48	Mains power terminals (230 V 50/60 Hz)
49	Switching-power-supply fixing screw
50	Cable for connecting Main Module
51	Protection Fuse: F 2A 250V
52	Switching-power-supply closure plastic rivet
53	Switching-power-supply anchor

* NOTE (1)

Before connecting the Fire control panel to PC for the PC programming phase, remove the jumper 34 (C3) of main board. After the programming phase is finished, replace the jumper otherwise the Earth fault (Leakage to Earth) will not be detected.

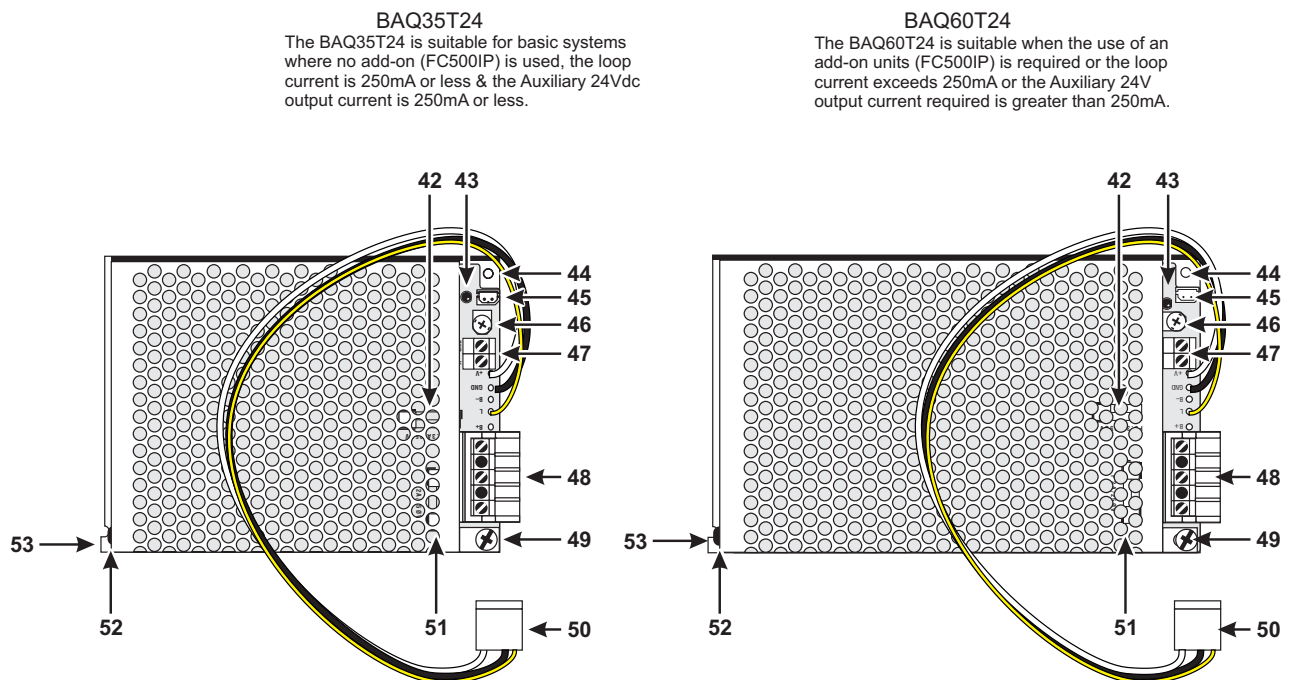



Figure 4 **BAQ35T24** and **BAQ60T24** Switching-power-supply

 **Installation of this system must be carried out strictly in accordance with the instructions in this section, and in compliance with the local safety regulations in force.**

Prior to commencing installation of the control panel, ensure that adequate precautions are taken to prevent damage to the sensitive electronic components on the display board and the control board due to electrostatic discharge. You should discharge any static electricity you may have accumulated by touching a convenient earthed object such as an unpainted copper radiator pipe. You should repeat the process at regular intervals during the installation process.

To install the fire panel work through the following steps:
➤ choose suitable mounting locations for the Control panel, detectors, fire warning and fire control devices.

 *The panel must be located in a clean, dry position, which is not subject to shock or vibration and at least 2 metres away from pager systems or any other radio transmitting equipment.*

➤ Lay the cables between the Control panel and the system peripherals.

 *Fire alarm cables must be separated from all other wiring (not related to the fire alarm system).*

- If necessary, install any accessory modules.
- Carry out the necessary connections, leaving the power-supply connection until last.
- Program the Control panel in accordance with the instructions in the "PROGRAMMING" section.
- Test the entire system (Control panel, detectors, fire warning and fire control devices).

 *FC500IP module (Accessory Modules) should be installed before mounting the Control panel as described in the paragraph: FC500IP module Installation.*

 **Ensure that the Control panel power supply (Mains and Batteries) has been disconnected before installing any accessory Modules.**

Installing the Control panel

Work carefully through the following steps (see the Figures 1 and 2).

1. Remove the screws (4) and open the Control panel.
2. Drill the anchor screw holes 7 and 14.

 *Check for water pipes and electrical wiring before drilling.*

 *When using 12Ah batteries use mounting holes 19 to provide additional support.*

 *Use the Tubular spirit level (23) for leveling the Panel backplate*

 **Check for water pipes and electrical wiring before drilling.**

3. If necessary, remove the surface conduit wire knockouts 2.

 *The cable conduit union with the cabinet must be secured by **HB Flame Class** (or higher) lock nuts.*

4. Pull the channeled undertrack cables through the cable entry 11 and 20 (for the power supply cable) then, using the anchor screws locations, secure the backplate to the wall.

 *Use anchors 12, (for the power supply cable) and 21 to secure the cables through the cable ties.*

■ Control panel closure

To close the panel:

1. Attach the cover to the hooks (6) and then rotate the cover down.
2. Use the screws (4) to secure the cover on the backplate.

Installing FC500REP Repeater

Repeaters can be wall mounted, or flush mounted to an **ave[®] BL08** outlet box (or similar).

Work carefully through the following steps.

LEDS AND KEYS LABELS

To insert the LED and Keys Labels (supplied) in the Repeater User Interface (see Figure below) work through the following steps:

- 1) Remove the screws 68 and open the Repeater FC500REP. Corresponding the A or B (in the overlay) insert the relevant LED and KEYS Labels.
- 3) Check that the labels are correctly inserted and then close the Repeater FC500REP.

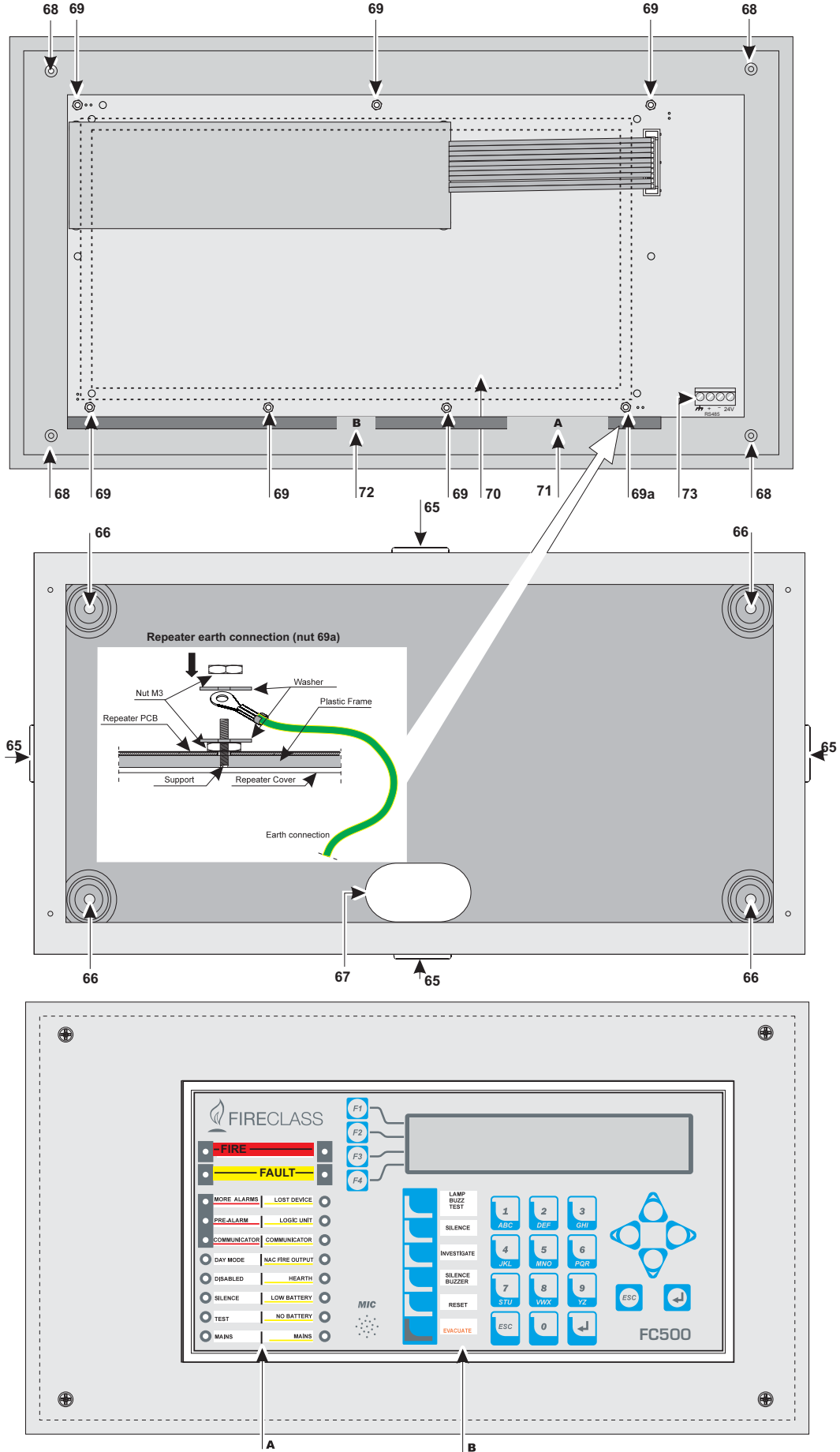

Figure 5 Installation FC500REP Repeater

1. Lay the connection cables (refer to “Connecting Repeaters”).
2. Remove the screws (68) (see Figure 5) and open the Repeater FC500REP.
3. If you are **flush mounting** the Repeater, go to step 4. If you are wall mounting the Repeater, drill the anchor screw holes (66).
4. Pull the wires through the wire entry (67), then, using the anchor screws, secure the Repeater to the wall.
5. Complete the connections to the terminal board 73 of the RS485 Interface, as described in the “Connecting Repeaters” section.
 - Connect the earth wire to the threaded support 69a on the cover, as illustrated in Figure 5.

P.	Description
65	<i>Knockouts for cables ducted externally</i>
66	<i>Holes for cabinet mounting</i>
67	<i>Cable entry for channeled undertrack cables</i>
68	<i>Screws to secure cover</i>
69	<i>Fixing nuts for User Interface on Cover</i>
69 _a	<i>Repeater nuts for earth connection</i>
70	<i>User interface Repeater board</i>
71	<i>LED label slot</i>
72	<i>Key label slot</i>
73	<i>Connector for the Repeater RS485 interface</i>

Description of the Terminals

This section describes the Control panel terminals.

■ Loop

LOOP1 Loop 1 terminals:

- +LEFT: Positive signal
- - LEFT: Negative signal (return).
- +RIGHT: Positive signal
- -RIGHT: Negative signal (return).
- -SH: Cable shield terminal.

LOOP2 Loop 2 terminals (as Loop1)

LOOP3 Loop 3 terminals (as Loop1)

 *The three loops of the panel can manage up to 128 addressable devices.*

 *The total length of the cables connected to the three loops must NOT exceed 2000 m.*

 *The max current load for the three loops must not exceed 500 mA +25%.*

■ Telephone line

LE Terminals for connecting the external telephone line.

LI Terminals for connecting the internal telephone line: connect these terminals to other telephone devices that need to share the same phone line as the fire panel.

 Terminal for connecting the earth wire.

■ Fire

[NC][NO][C] Non-supervised **fire** output. Dry contact relay for non-supervised devices.

It is activated, by default, at the entering of the panel in to the alarm status (first fire event).

The de-activation of the fire output is executed during the panel reset.

The fire output may be silenced (programmable option; default=NOT silenceable).

The fire output may be disabled.

The fire output may be programmed to works differently (only via FCConsole Software).

➤ During standby status, terminal [C] closes to terminal [NC];

In the event of fire, terminal [C] closes to terminal [NO].

 *EN54-2 certification applies ONLY when FIRE output is not C and/or J and/or G (EN 54-1) type. Therefore this output MUST NOT BE UTILIZED to manage Fire Alarm devices and/or Fire/Fault transmission devices and/or Automatic Fire alarm system.*

■ Fault

[NC][NO][C] Non-supervised **Fault** output. Dry contact relay for non-supervised devices.

It is activated at:

➤ the entering of the panel in to the fault status (first fault event).

➤ in the case of Logic fault

➤ in the case of total loose of the power.

The de-activation of the fault output is executed during the panel reset.

The fault output may not be silenced.

The fault output may not be disabled.

The fault output may not be programmed to works differently.

➤ During standby status, terminal [C] closes to terminal [NC];

➤ In the event of fault, terminal [C] closes to terminal [NO].

 *EN54-2 certification applies ONLY when FAULT output is not J (EN 54-1) type. Therefore this output MUST NOT BE UTILIZED to manage Fault transmission devices.*

SC1 (Sounder Circuit) Supervised/Silenceable/Bypassable (Disabled) Bell output, for the Alarm signalling devices. Terminals for the connection of devi-

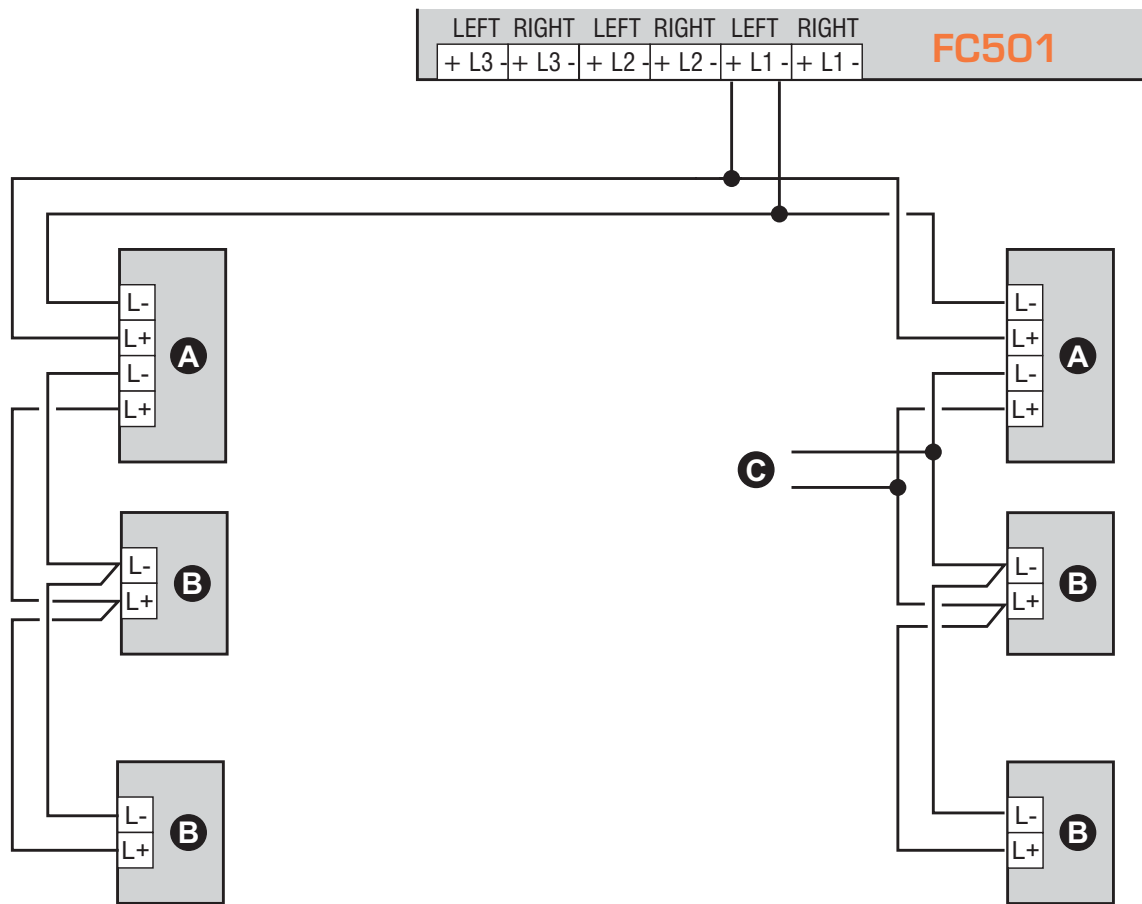

Figure 6 1) Wiring diagram of a 2-wire connection, **a)** Isolators; **b)** Compatible analogue devices (Fire detector, Input modules, Output modules, Manual callpoints); **c)** T connection.

ces that are activated with the positive (24V) and must be supervised.

During standby status: negative pull-down to 0 V on [+] terminal; positive pull-up to 27.6 V on the [-] terminal. When control panel is in alarm status: positive pull-up to 27.6 V on the [+] terminal; negative pull-down to 0 V on the [-] terminal.

SC1 can be Silenced (forced to standby) by the menu command **DISABLE**.

This output is not programmable, it is activated every time the control panel goes into ALARM status.

SC2 (Sounder Circuit) Supervised/Silenceable/Bypassable (Disabled), Programmable Bell output, for the Panel Alarm signalling or Panel Pre-Alarm or Panel Warning or Panel Fault or 1,2,3 or 4 Software zones(OR) Alarm, or 1,2,3 or 4 Software zones(OR) Pre-alarm, or 1,2,3 or 4 Software zones(OR) Warning or 1,2,3 or 4 Software zones(OR) Fault or 1,2 or 3 Points(OR) Alarm or 1,2 or 3 Points(OR) Pre-Alarm or 1,2 or 3 Points(OR) Warning or 1,2 or 3 Points(OR) Fault.

During standby status: negative pull-down to 0 V on [+] terminal; positive pull-up to 27.6 V on the [-] terminal. When a programmed event occurs: positive pull-up to

27.6 V on the [+] terminal; negative pull-down to 0 V on the [-] terminal.

The SC1 and SC2 outputs can be forced to standby by resetting the control panel.

The SC Outputs will hold standby status for the programmed Silence Time. If Alarm conditions are present when the programmed Silence Time expires for the SC1 or another programmed event for the SC2, they will re-activate.

SC1, SC2 accept devices that operate within SELV limits ONLY.

The SC2 output, if programmed as SC1, will be of type C.

If the 2-wire connection loop is used, the EN54-2 certification applies ONLY when the total number of devices (detectors, manual callpoints etc.) does not exceed 32.

■ Audio station

MIC|SPK|BLK|RED Terminals for future use.

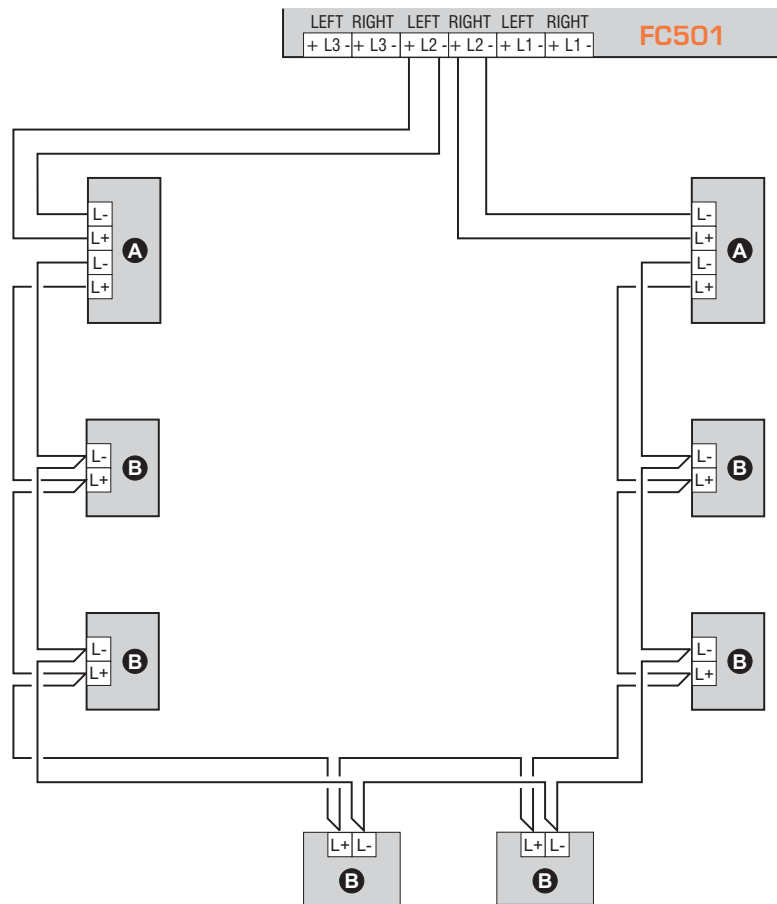

Figure 8 Wiring diagram of a 4-wire connection: **a)** Isolators; **b)** Compatible analogue devices (Fire detector, Input modules, Output modules, Manual callpoints).

■ Auxiliary outputs

OC1-OC2 Silenceable, Bypassable (Disabled), NOT Supervised Outputs, programmable. These are open-collector terminals for the Panel Alarm signalling (Default) or Panel Pre-Alarm or Panel Warning or Panel Fault or 1,2,3 or 4 Software zones(OR) Alarm, or 1,2,3 or 4 Software zones(OR) Pre-alarm, or 1,2,3 or 4 Software zones(OR) Warning or 1,2,3 or 4 Software zones(OR) Fault or 1,2 or 3 Points(OR) Alarm or 1,2 or 3 Points(OR) Pre-Alarm or 1,2 or 3 Points(OR) Warning or 1,2 or 3 Points(OR) Fault, which will close to ground, when the connected event becomes active, and will re-

main in this state until the generating event has ended (so after a manual reset or a fault restore).

☞ *The output OC1 can also be programmed to signal the failure of the telephone line so as to be used in combination with a relay, for switching from the **primary phone line** to the **reserve line**.*

The OC1 and OC2 outputs can be forced to standby by resetting the control panel.

The OC1 and OC2 outputs will activate with a delay equal to the Pre-alarm time when the programmed event occurs.

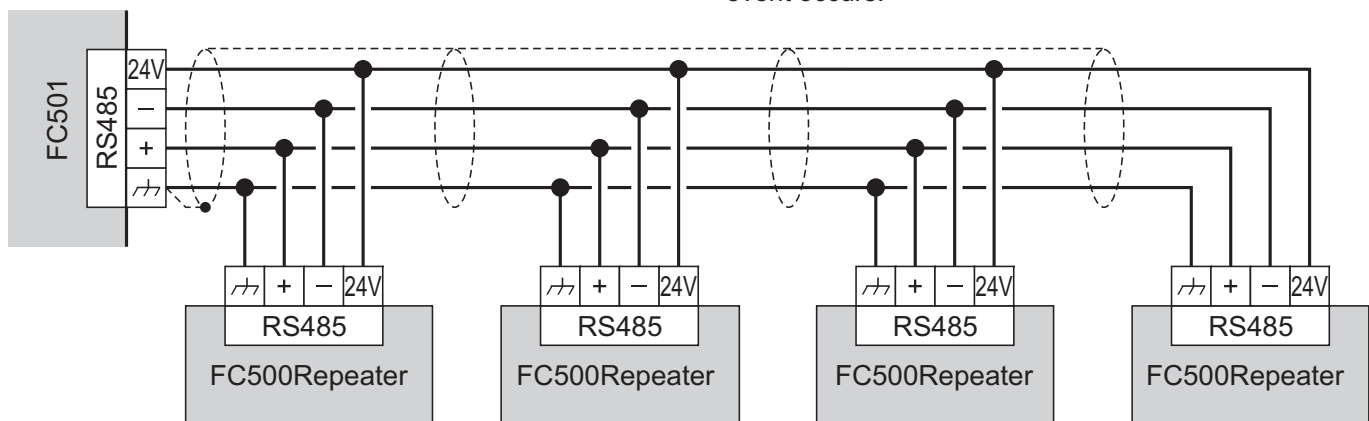

Figure 7 Wiring diagram of four (max) FC500REP Repeaters connected to the RS485

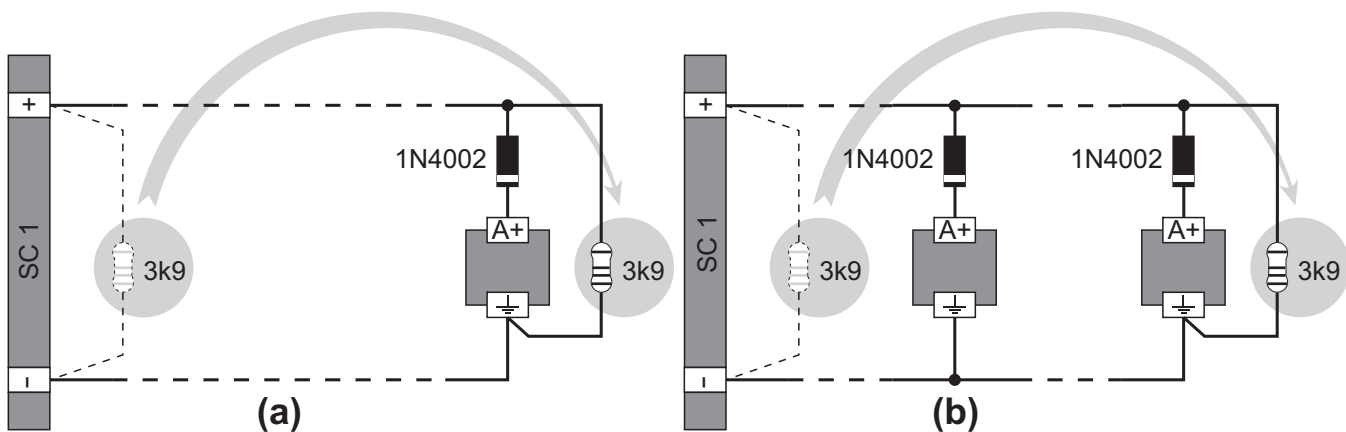

Figure 9 Wiring diagram of the connection of a single device (a) and several devices (b) to Bell outputs (device activated by positive (27.6 V) on terminal [A+]).

☞ EN54-2 certification applies ONLY when OC1 and OC2 outputs are not C and/or J and/or G (EN 54-1) type. Therefore this output MUST NOT UTILIZED to manage Fire Alarm device and/or Fire/Fault transmission devices and/or Automatic Fire alarm system.

24R [↗] Reset able auxiliary power supply to devices that operate at 24 V (0.5A max) (powered by the standby batteries):

- Positive (27.6 V) on terminal [24R];
- Negative on terminal [↗].

☞ This power supply is disconnected during the reset of the Control Panel (about 2 s) so it is suitable for devices that are restored when power supply is disconnected.

24A [↗] Auxiliary Power supply to devices that operate at 24 V (0.5A max) always present and guaranteed by the batteries:

- Positive (27.6 V) on terminal [24A];
- Negative on terminal [↗].

■ RS485

24V|-|+|↗ Terminals for FC500REP repeater (maximum 4) and FC500MFI module (maximum 4) (0.5A max).

- Serial bus terminals [+] and [-];
- 27.6 V power voltage terminals [↗] and [24V].

☞ The maximum cable run allowed is 1000m.

■ Battery

+BAT- Terminals to connect the batteries inside the FC501 control panel.

The System Wiring

⚠ **High Voltage leads (230 V) must be bunched separately from Low Voltage leads (24 V). All leads must be bunched in such a way as to avoid contact with other wiring and components.**

■ Connecting Addressable Devices

The control panel has 3 loops for addressable analogue devices.

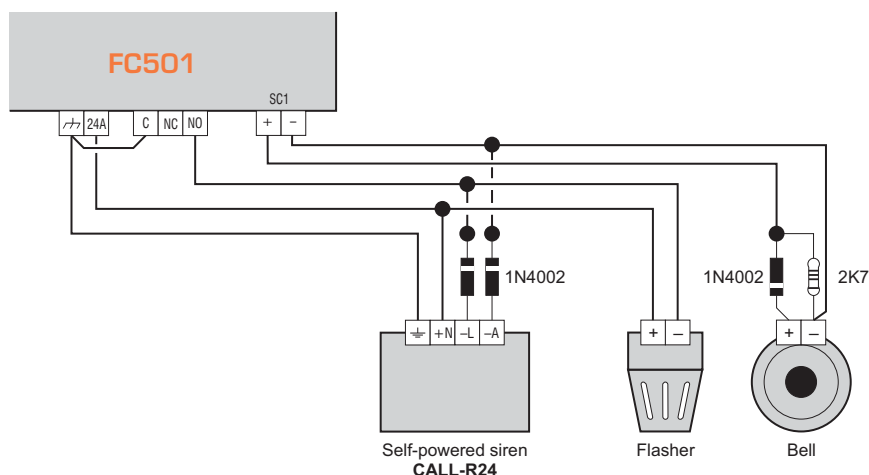

Figure 10 Wiring diagram: NON-silenceable and Silenceable Output connections

The maximum for all 3 loops is 128 addressable analogue fire detectors and analogue devices (Input modules, Output modules).

Every detector and module connected to the loops must be assigned a unique address.

You can use 2 or 4 wires for the loop connections.

NOTE: The loop connection type must be specified during the programming phase.

Figure 6 illustrates the 2-wire connection to Loop1.

Figure 8 illustrates the 4-wire connection to Loop2.

Whatever the type of connection performed, make sure that any short circuit or open circuit in the wiring does not lead to the loss of more than 32 detectors. An isolator should be fitted at least every 32 detectors.

If the connection is 2-wire connection type, addressable analogue fire detectors and analogue devices (Input modules, Output modules) connect on the left.

Use only shielded cable for all connections, with one end of the shield connected to the SH terminal of the Control panel and the other left free.

■ Connecting Repeater FC500REP

An example of how to connect two FC500REP repeaters in Figure 7.

The RS485 port of the FC500 (terminals [↗], [+], [-] and [24V]) accepts up to 4 FC500REP repeaters;

Terminals [+] and [-] supply the power (27.6 V) to the repeater panels (see figure 7).

When a mains fault occurs, the Repeaters considerably decreases the absorbed power, switching off the LCD display backlighting (the LCD display backlighting switches on again, for 20 sec. when a key will be pressed). But the absorption of the Repeaters connected to the control panel, will contribute to run down the backup batteries, and so the decrease of the Stand-by supply

time of the system.

As one control panel only is in the system all the Repeaters must be supplied by the control panel itself, unless a Power supply Station is in the system.

Use only shielded cable, with one end of the shield connected to the earth terminal of the Control panel and the other left free; the continuity, between several segments of connection must be secured.

■ Connecting Output Devices

The control panel has supervised outputs, NON supervised outputs and 2 Bell outputs.

Output devices can be connected to the loops by means of Output modules.

■ Bell Outputs

The Bell outputs are indicated by the letter SC and their address number.

The SC1, and SC2 Bell Outputs are Supervised, Silenceable, Bypassable (Disabled) SC2 also Programmable.

The Bell outputs can be forced to standby status by means of the SILENCE button. Once an alarm has been acknowledged, you can silence the audible signalling devices and leave the visual signalling devices active until the alarm conditions cease.

For example, a connection similar to the wiring diagram in figure 10 will activate the Flasher, the Bell and the visual and audible signalling device of the Self-powered Siren in the event of an alarm.

Using the **SILENCE** button will stop the horn but not the flasher, which will continue to signal Alarm status until the RESET button is pressed.

Connecting the Power Supply

The power circuits of this Control panel comply with the EN54-4 standard.

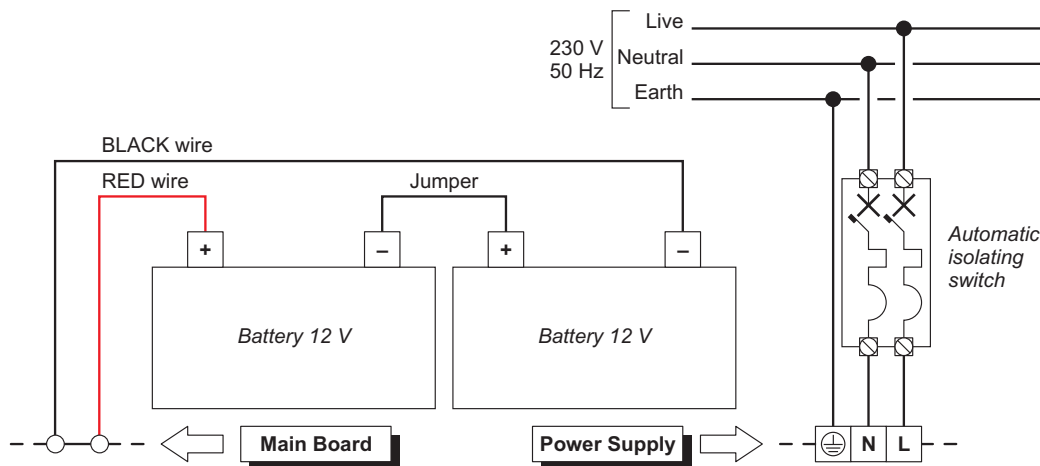



Figure 11 Wiring diagram for the power supply

 **In order to comply with the Safety regulations in force, the Mains must be equipped with a bipolar isolating device for protection against over voltage and short-circuit to Earth (e.g. automatic isolating switch).**

This Control panel is powered from the Mains (230V 50/60 Hz) through a switching power supply, located inside the case. The **FC501-L** Control panel provides housing for two 12V, 7Ah or 12Ah maximum batteries; the **FC501-H** Control panel can be connected to two 12V, 12Ah or 38Ah in an external metal box (see Figure 14) for power during Mains failure.

The non-volatile memory will hold the programmed data at all times.

In the event of MAIN failure, the:
AMBER Power Supply LED will turn ON.

The Control panel will check the batteries at all times, (refer to **Static Test** and **Dynamic Test**).

Static Test The **Static** Test monitors the battery charge during Mains failure. In the event of **Low battery** status (below 22.8 V), the **Low Battery** LED will turn ON. If this occurs, the Mains power must be restored before the batteries empty, otherwise, the system will shut-down.

Dynamic Test The **Dynamic** Test monitors the operating capacity of the batteries. In the event of a Failed Test result (batteries do not meet the Test requirements), the **No Battery** LED will turn ON. If this occurs, the backup battery must be replaced immediately, otherwise, the system will be unable to function in the event of Mains failure (black-out).

Work carefully through the following steps to connect the Mains Supply.

1. Locate the backup batteries in the housing (see Figure 2) .
2. Secure the batteries to the backplate of the panel, using the cable ties, in the appropriate opening.
2. Using the Jumper (supplied), connect the batteries in series.
3. Observing the battery polarity, connect the battery terminals to terminals -BAT+ on Main Board (wires supplied).
4. **FC501-L** use 7 or 12Ah @ 12 V YUASA batteries; **FC501-H** use 12 or 38Ah @ 12 V YUASA batteries or similar with case flame class UL94-V2 (or higher).
5. Connect the switching power supply BAQ35T24/BAQ60T24 with the 'external power supply (Main): connect the **Earth** wire to the [⊕] terminal on the mains terminal block **48**.

6. Connect the **Neutral** wire to terminal [N], and the **Live** wire to terminal [L] on the terminal board **48**.
7. Connect the BAQ connector 50 to the main Board connector 16.

 *The Control panel will reset on power up.*

 **DO NOT allow the power cable to cross over other wiring (see Figure 2). The power cable must be routed and held firmly in place by a two cable tie.**

■ Thermal Probe

This Control panel supports the **KST** thermal probe. The probe will optimize the battery charging process by regulating the charge voltage in accordance with the battery temperature.

Work carefully through the following instructions (refer to the figure 13:

1. Connect the probe **54** to the connector **45** on the BAQ35T24/BAQ60T24 switching Power supply.
2. Attach the probe to one of the batteries, in such a way as to obtain optimum heat transfer.
3. Measure the Probe temperature.
4. Using the graph in Figure 12 and/or Table 7, find the value (in accordance with the battery temperature) that the output voltage of the Switching Power Supply will be based on.
5. Using the trimmer **46**, adjust the voltage on the terminal board **47** to the required value.

 *To verify the battery efficiency, the charger circuit will measure the internal resistance of the batteries. In order for this measure is not distorted, you should use only the cables supplied; cables that are longer and/or have an insufficient section may erroneously simulate the condition of an inefficient battery.*

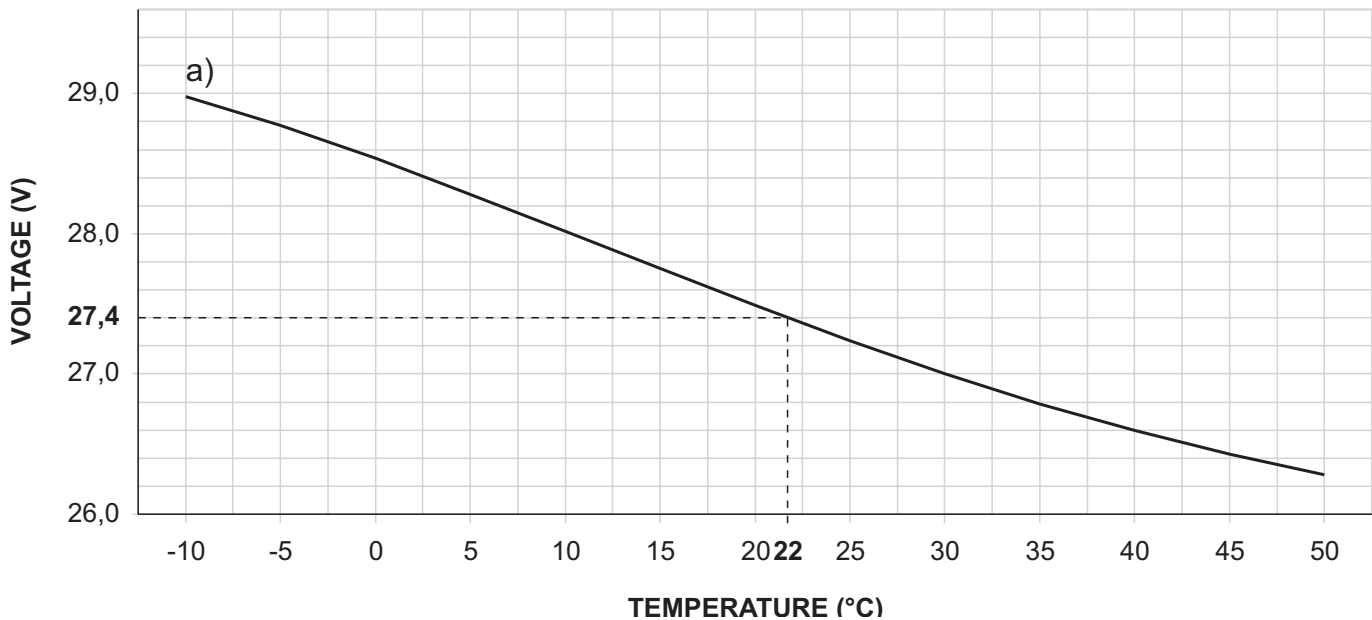

Figure 12 Switching Power Supply Output Voltage graph. To find the Output Voltage using the graph: — indicate the Probe temperature on the **TEMPERATURE (°C)** axis; draw a line from the temperature value point up to the curve **a)**; draw a line from the intersection point across to the **VOLTAGE (V)** axis; adjust the Output Voltage of the Switching Power Supply to the resultant value. For example, if the Probe temperature is 22 °C, the Output Voltage of the Switching Power Supply must be set at 27.4 V.

TEMPERATURE (°C)	-10	-5	0	5	10	15	20	25	30	35	40	45	50
VOLTAGE (V)	29,0	28,8	28,6	28,2	28,0	27,8	27,6	27,2	27,0	26,8	26,6	26,4	26,2

Table 7 Switching Power Supply Output Voltage chart. To find the Output Voltage using the chart: — select the nearest value to the Probe temperature on the **TEMPERATURE (°C)** row; read the respective value on the **VOLTAGE (V)** row; adjust the Output Voltage of the Switching Power Supply to the indicated value. For example, if the Probe temperature is 22 °C, the Output Voltage of the Switching Power Supply must be set at 27.4 V.

Installing FC500IP board

The IP Module should be installed into the base of the control Panel, as illustrated in Figure 13. Proceed as follows:

⚠ Before installing the FC500IP Module, disconnect control panel from its power supply (mains and the batteries).

1. Open the control panel by unscrewing the two screws 4, then lift the cover from the bottom to separate it from the backplate. Remove the fastening screw, figure 2, item 22, between the motherboard and the backplate and unlock the support of motherboard + User Interface, figure 2, item 9, using a flat screwdriver. Lift the control board & display from the base.

2. Fix the IP Module on the base of the control panel using the supplied screws **56**.

3. Connect connector **57** of the IP Module to the connector **58a** of the control panel using the supplied flat cable **55**.

4. Connect connector **59** to the LAN using an Ethernet cable.

👉 Use a category 5 (or better) shielded Ethernet cable (STP or FTP).

5. Re-fit the control board & display and secure with the screw.

6. Reconnect the control panel to the power supply.

7. Program the IP Module as described in the section “PC Programming” on page 29. For further information, please refer to the dedicated manuals.

👉 See page 29, paragraph “To connect the control panel to a PC remotely”.

Installing the 38Ah battery metal Box

Work carefully through the following steps (see Figure 14), for the FC501-H fire panel only.

1. Remove the two screws on the cover and open the metal box.
 2. Drill the anchor screw holes **64**.
- ⚠ **Check for water pipes and electrical wiring before drilling.**
3. If necessary, using a hammer or similar tool, remove the surface conduit wire knockouts of the metal Box.
 4. Secure the metal base to the wall.

👉 *The cable conduit union with the cabinet must be secured by **HB Flame Class** (or higher) lock nuts (see particular in fig. 14).*

5. Pull the wires through the cable entry and connect them. See paragraph: "Connecting the power supply".

P.	Description
54	Thermal probe (see Fig.13 and14)
55	Flat cable for the connection with FC500IP
56	FC500IP fixing screws
57	FC500IP board
58	Flat cable connector
58a	Flat cable connector from FC500IP
59	Ethernet connector
60	38Ah Batteries cabinet (Accessory item)
61	Connecting Threaded tube
62	Nuts on Control Panel Backplate (FC501-H only)
63	Nuts on 38Ah Batteries Backplate (FC501-H)
64	Holes for cabinet mounting

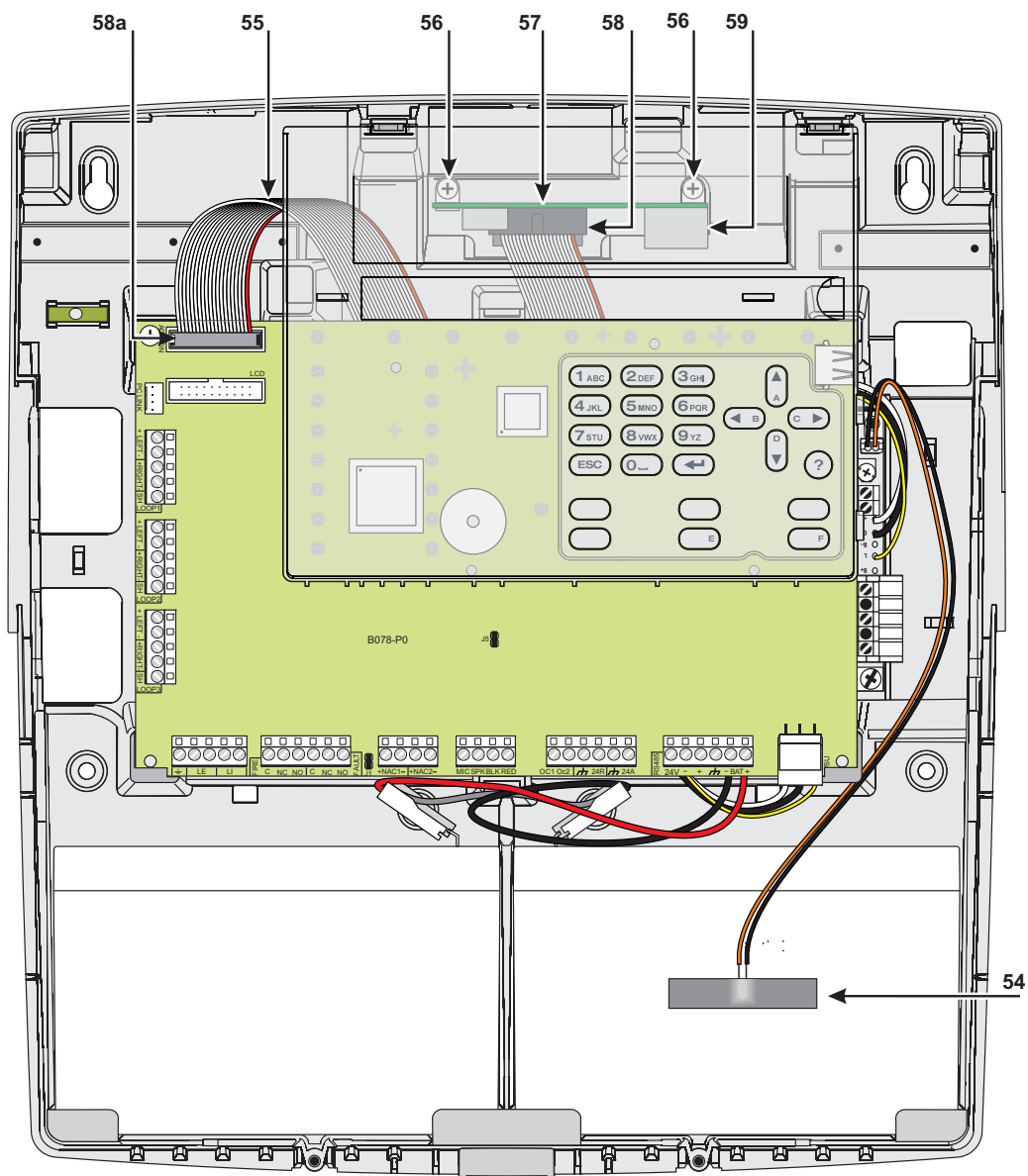

Figure 13 FC501 connection with the FC500IP.

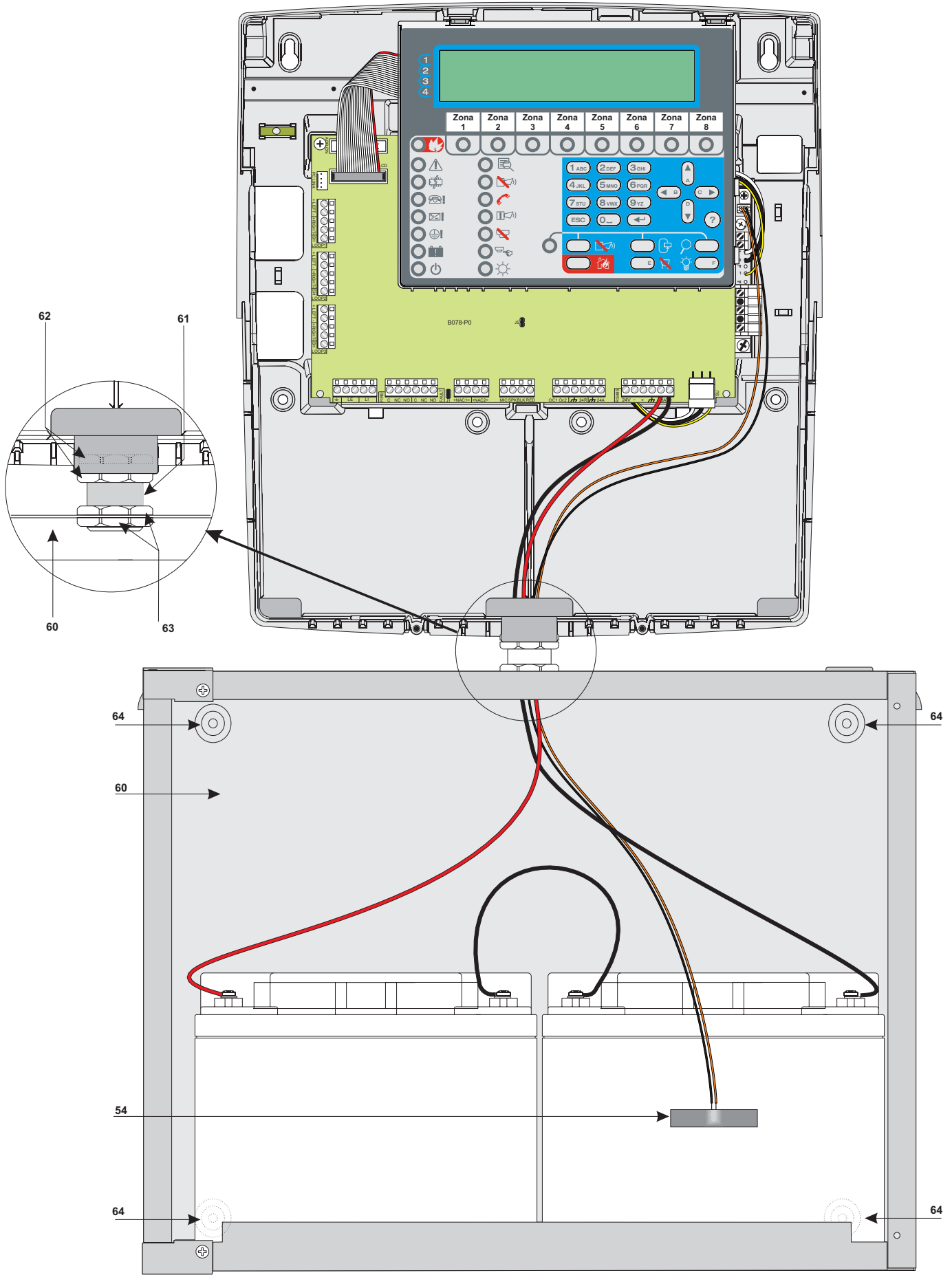

Figure 14 Control Panel and 38Ah Batteries metal Box connection (accessory item).

Maintenance

In order to ensure that the system can continue to operate normally it must be maintained with regular testing by the user and periodic maintenance by the installer in accordance with local laws.

For the maintenance of other devices such as detectors, modules, etc. follow the dedicated instructions for the devices.

The following operations must be carried out regularly.

A Using a damp cloth (DO NOT USE SOLVENTS OF ANY KIND), remove dust from the Control panel cabinet.

B Using the **Lamp Test** key, check that the LEDs and buzzer are functioning properly.

C Ensure that the batteries are sufficiently charged and functioning properly. If not, replace them immediately.

D Ensure that all cables and connections are intact.

E Ensure that there are no unrelated objects inside the Control panel case.

F Ensure that the control panel is capable of processing a fire alarm and operating the relevant sounders and/or outputs in consequence of this alarm. If there is a facility for transmission of fire alarm signals to a Central Station, it should also be ensured that the signal is correctly received.

G Also verify the actual functionality of the circuit for the detection of earth fault. The procedure is as follows:

- connect one of the SH terminals of the loop to the ground;
- verify that the fault is reported correctly by the Fire Panel;
- remove the connection previously made.

Points **A** and **B** may be carried out by users. Points **C**, **D**, **E**, **F** and **G** must be carried out by qualified persons only.

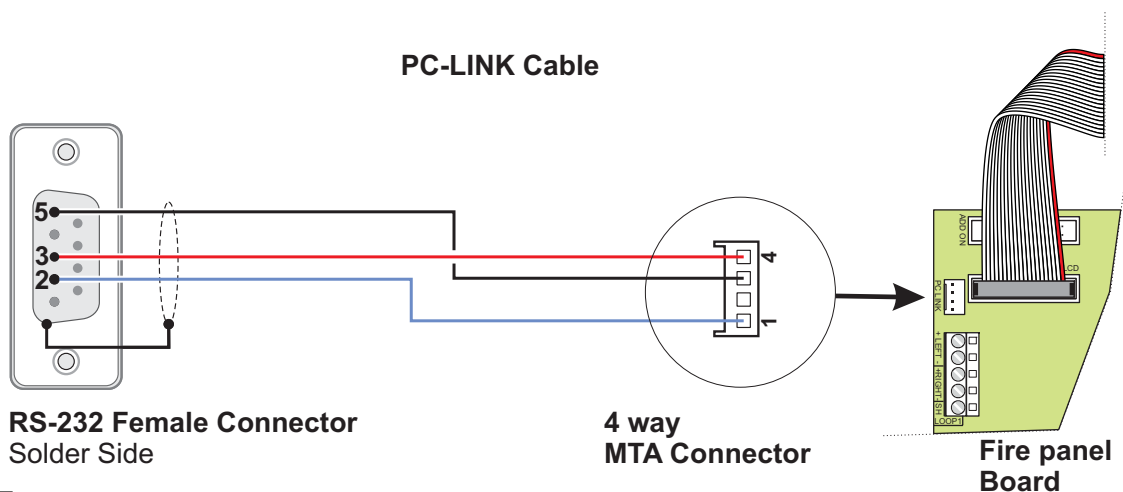

Figure 15 Schematic diagram of the PCLink cable

The system can be programmed from the Control panel (User Interface) or from a computer, using the **FireClass Console**. This section describes how to program the system from a computer. If you intend programming the system from the Control panel refer to the "PROGRAMMING FROM THE PANEL" section. To manage and program the FC501 control panel by a PC the **FireClass Console** application must be installed on the PC.

Installation

Work carefully through the following steps to install the **FireClass console** application.

- Ensure your PC is running Windows XP or above.
- Ensure you are logged on with Administrator rights.
- In Windows, click on the START button then select "My Computer".
- Select (double-click) the local Hard Disk Drive (Usually Drive 'C').
- Create a suitable directory (e.g. C:\FCConsole).
- Copy the Fireclass Console Files into this directory. If you have a ZIP file, then extract the files into the directory.

☞ *There should now be a File called "Fireclass Console" in your directory. Note: This file has a '.exe' extension which may or may not be visible.*

- Click the right mouse button on the file "Fireclass Console" and select COPY from the menu. Click the right mouse button anywhere on your desktop (near to the various icons).
- Select 'Paste Shortcut' from the menu.
- You can now double-click the Fireclass Console shortcut icon to run Fireclass Console.

☞ *When FireClass Console starts for the first time will prompt you to choose the country you belong to, select and press the check button  to confirm.*

Select language

You can select the language of the FireClass Console, from the **Languages provided**.

To Select the application language:

- Run the **FireClass Console** application;
 - Select **Tools** from the **Main** window;
 - Select **Language** from the drop-down menu to open a window with the language list;
 - Select a language from the **Language** list;
- The selected language will be immediately initialised.

Software window Look

To modify the look of the FireClass Console window, select **Tools** from the **Main** window and click "Skin".

This option allows you to modify the look of the window in the offer range (see Figure 16).

Control panel connections

If you are using the Supervisory, Management, Downloading and Log Management functions, the control panel must be connected to your PC in local communication (RS232/USB) or remote by PSTN line, GPRS or LAN.

To connect the control panel in local:

connect the PCLINK connector of the control panel (see Figure 3, item 40) to a serial port of the PC using the PCLINK cable (accessory item, see Figure 15) or use the USB socket of the control Panel (see Figure 3 item 26) and a USB cable (Type A-A) or the USB BENTEL cable **USB5M** (length 5 m.).

To connect the control panel to PC remotely:

Install the FC500 IP board and connect it with the motherboard via the flat cable. In this way you can activate the Digital Communicator functions. If you need both the functions of the Digital Communicator and the PC Interface, both the flat cable and the PCLINK cable are required. If you require only the function of PC interface, both cables FLAT and PCLINK are needed, but the digital communicator function will be excluded by software.

If the control panel is **not connected** to your PC when you start the communication, the following warning will be shown: "**Response from Panel Timed!**" If the serial port for the local communication is invalid, the following warning will be shown: "**Cannot open serial port!**".

Main window

From the FireClass Console main screen, select "**File**" and then "**New**", to display the window as shown in figure 18 where you can select the Firmware Release of the Control Panel to program. Click on the green tick to ac-

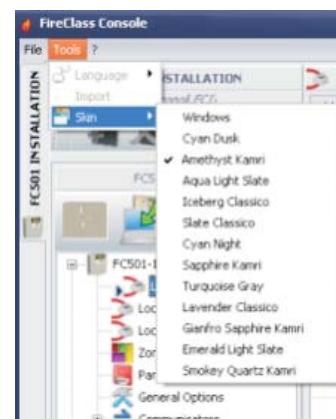

Figure 16 To modify the window look (skins).

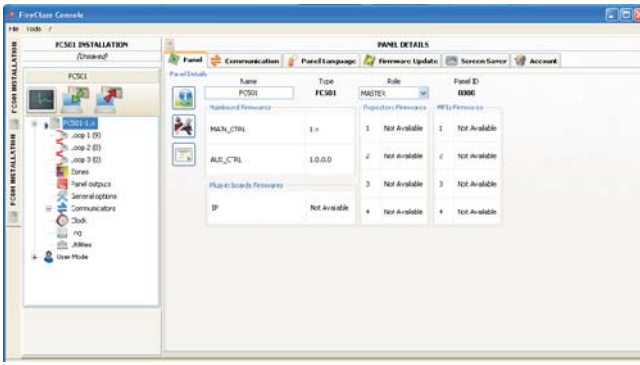







Figure 17 Control Panel Details window.

cept the selection. The following sections describe the **File**, **Tools**, and **Help** menus.

■ Icons description

-  Click on this icon, opens the window in Figure 17 "Panel Details" where you can check/insert various programming.
-  Click on on this icon in the window shown in Figure 21, you can see the details of the Panel, enter the name and address of the Control Panel/Customer.
-  Click on this icon to download the programming (via serial link) to the connected control panel.
-  Click on this icon to upload all the programming of the connected Control Panel.
-  Click on this icon to select the Loop for inserting devices.
-  Click on the icon to start operations in Real Time. This feature allows you to view the status of the FC501 control panel in real time on a computer using the FC500IP module connected to the network or using the serial port.

■ File menu

The menu **File: New, Open, Save, Save as, Close, Exit** will allow you to manage customer account data.

New The **New** option creates a New installation and assigns the factory default values to all programming parameters.

Open Click on "Open", to retrieve a previously saved customer installation file. Locate the required installation file and double click it to open it.

 You can have more than one installation file open at the same time. Pay attention to the tabs on the left-hand side to ensure you are editing the correct file.

Save If the installation data is modified, click on "Save" to save the changes to the current installation.

Save as If you have created a new installation or want to save an existing installation under a new name then click on "Save as".

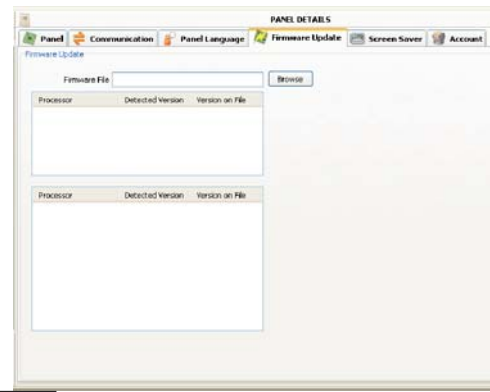

Figure 19 Firmware Update window

Close Click on "Close" to close the current installation. You will be prompted to save any changes made.

Exit Click on "Exit" to close Fireclass Console. You will be prompted to save any changes made to the current installation.

■ Tools menu

Language See paragraph "Select language" on page 29.

Skin To change the look of FireClass Console, click on **Tools** and then **"Skin"** that allows to choose, in a list, the available looks (see Figure 16).

Advanced In this section you can set the Tooltip duration; Load the driver to use the USB. It is also possible to associate the files .FCI (files generated by the programming/management of the fire system) with FireClass console, so to open it just click on it.

Panel Details

Click on this icon , the window in figure 17, will be shown, where we have the following menu tabs:

- Panel
- Communication
- Panel Language
- Firmware Update
- Screen Saver
- Account.

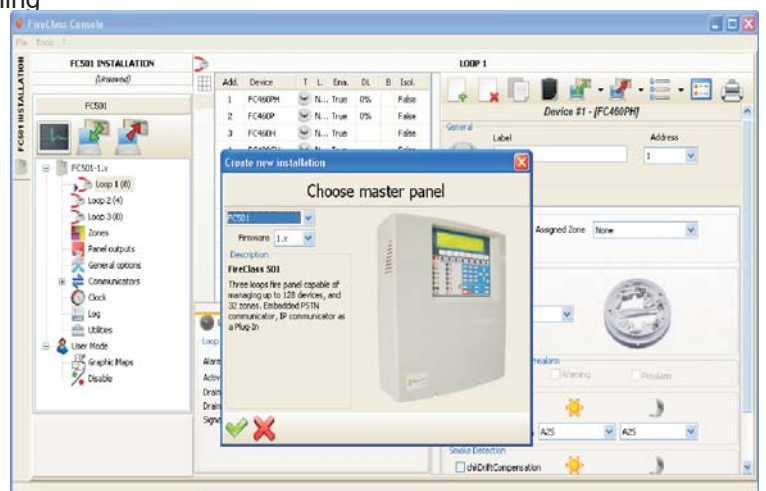

Figure 18 From File menu and then "New".

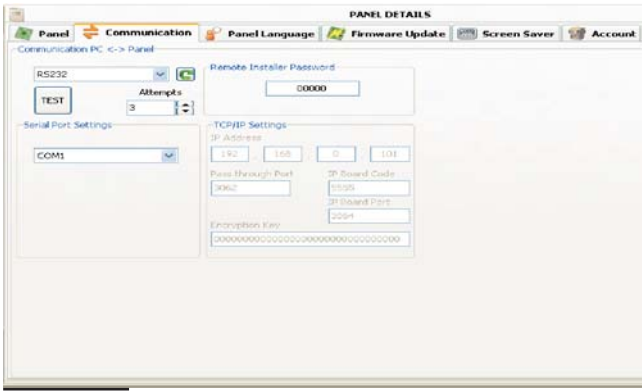

Figure 20 Communication window.

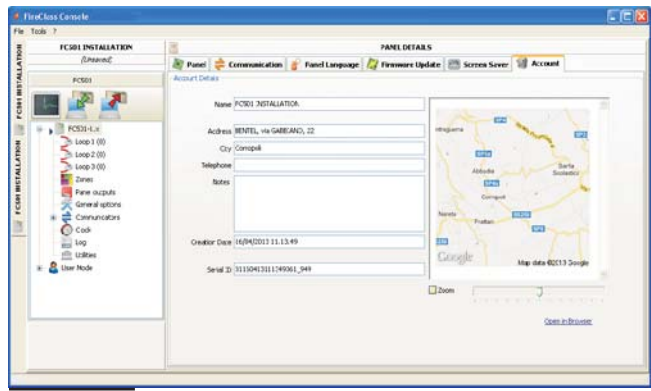





Figure 21 Account window.

■ **Panel Details Menu**

In this window, it is possible to enter the name of the Panel/Customer. By clicking on the icon  it is possible to check the firmware version of MainBoard, Loop controller, User Interface, Repeater and FC500FMI module. Click on the icon  to restore the Control Panel to the factory default.

Click on the icon  to open the Installation Manual.

■ **Communication Menu** 

In the Communication menu you can choose the connection mode between the Panel and the PC: TCP/IP, RS232 or USB. Click on the icon , to update the type of connection, and click on the **TEST** button to verify the functionality of the connection status. In the TCP/IP mode, it is necessary to enter the FC500IP parameters and the Installer password already in the system. The IP Module screen is used to program the parameters corresponding to the IP Module as described below.

- **IP address** – Enter the IP address assigned to the IP Module you wish to program or, if DHCP (dynamic IP address) mode has been selected, contact the network administrator to request details of the IP address assigned to the IP Module. Alternatively, follow the procedure outlined in the “View IP address” paragraph to view the IP address on the control unit display.

The default setting is 192.168.0.101.

- **IP Module port** – Enter the details of the port assigned to the IP Module you wish to program (contact the network administrator).

The default setting is 3064.

- **IP Module code** – Enter the access code assigned to the IP Module you wish to program. The default setting is 5555.

Encryption key – Enter the encryption key assigned to the IP Module you wish to program. The default setting is 32 zeros.

■ **Language Menu** 

The Language menu allows you to change the system language (User Interface or Repeater) to any of the languages currently loaded. In the **Loaded Language** section, click on **Change System Lan-**

guage , then select the language and the device

(User Interface or Repeater) click-on  to override the language in the Control panel memory. As soon as the download of the new language is completed, the panel will start to use it, and update any peripherals, if necessary.

■ **Firmware Update menu** 

Click on “Firmware Update”: the window (see figure 19) will be shown. From a source file, this option allows the Firmware Update of all system interface: Mainboard, User interface, Loop controller, Repeater.

*If the FC500REP repeater has a Firmware V3 or less, and the language is Italian while on the Panel there is English, the installer after the firmware update, have to realign the strings of languages, performing the process of language change (see **Program 8 Key-System**)*

■ **ScreenSaver menu** 

In the ScreenSaver menu it is possible to insert 4 lines of text (such as Installer address/telephone) that will be loaded on the display of the User Interface when the panel is in the stand-by status. The four row could be: Steady or Scroll or Blink.

■ **Account Menu** 

In the Account menu enter the account data, and for better identification of the account, after entering the address (location) by clicking on the address field, the software will

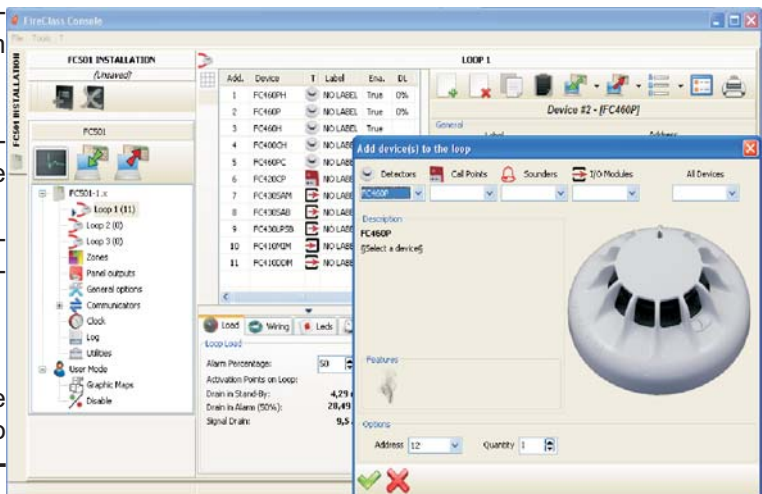

Figure 22 Devices programming window

attempt to find the address using Google Maps (assuming you have an active internet connection).

■ Help Menu ?

Click on **Help** option; a technical support file will be opened. This application allows you the learning and the use of FireClass Console.

Programming Pages

The programming pages of the system are:









- Loop devices
 - Zones
 - Panel Outputs
 - General Options
 - Communicators
 - Clock
 - Log
 - Utilities
 - User mode
- illustrated below.

Loop Devices programming

In the window on the left, click on the panel name to expand the tree view. Then click on the required loop (1,2 or 3). The devices programming window will shown (Figure 22).

On the right of Loop1 or Loop 2 or Loop3, the current number of devices is shown in brackets ().

■ Description of the icons in the tool bar.

-  Add Device: select new devices;
-  Remove device: remove the installed devices;
-  Copy device on the clipboard: allows you to copy the device data to the clipboard for use in another account.
-  Paste clipboard content: allows you to add device data previously copied to the clipboard.
-  Read Loop: allows you to upload the current loop data from the panel (via the serial data link).
-  Send Element(s): allows you to download the current loop data to the panel (via the serial data link).
-  Device's details: this open a new window to allow you to see status of the device.
-  Selection: allows you to select all devices or invert the current selection.
-  Print to file: print to a .csv file the list of devices of the selected loop. The .csv file can be edited with Microsoft Excel.

If different devices have common programming parameters, you can use the multiple selection of the devices and assign the same parameters.



Figure 23 Detectors parameters programming Window

Select devices Click on **Panel 1**, select **Loop 1** or

Loop 2 or **Loop3**, click on “new device” , the window in Figure 22 will shown. Select the programming device, check the address, (autoaddressing) and then click on the tick ✓ (Enable) to add the device to the loop. For others devices, repeat the same procedure. The detector type is shown by the icon in the Features field.

Remove devices Select the device in the list, then click on “Remove device” , and then click YES to remove or NO to cancel (see Figure 24).

Loop Loading At the bottom of the programmed devices list, Figure 23, there is a **Loop Load** section. This windows displays the number of Activation points on the loop, the Drain in stand-By, the Drain in Alarm and the Signal Drain. The Alarm percentage can be adjusted.

The remote LEDs may be entered in the calculation.

The percentage shown in the “Loop drain in alarm (50%)” is the programmed value in “Battery calculation” an option of **Utilities** page (see dedicated paragraph), for the battery calculation after the cable length is ente-



Figure 24 Detector Disablement confirmation window.

Detector Class	Typical application Temperature °C	Max. Application Temperature °C	Min.Static Response Temperature °C	Max.Static Response Temperature °C
A1	25	50	54	65
A2	25	50	54	70
B	40	65	69	85
C	55	80	84	100
D	70	95	99	115
E	85	110	114	130
F	100	125	129	145
G	115	140	144	160

Table 8 Detector classification Temperature - Detector shall conform to one or more of the following classes: A1, A2, B, C, D, E, F or G . Manufacturers may optionally give additional information concerning the type of response exhibited by the detector, by adding the suffix S or R to the above classes. Detectors, with a suffix **S** to their class, do not respond below the minimum static response temperature, even at high rates of rise of air temperature. Detectors, with a suffix **R** to their class, incorporate a rate of rise characteristic, which meets the response time requirements for high rates of rise of air temperature even when starting at air temperature substantially below the typical application temperature (EN54-5:2000).

red; it is possible to choose the type of cable if you have a database.

■ Loop wiring Calculation

The tab next to the Loop Load tab is the Loop Wiring tab. This gives you the maximum permitted resistance of the loop based on the cable length and the Alarm Percentage. If cable data is available from the Utilities section then suitable cable may also be shown.

■ Detectors parameters programming

Click on a device in the Device list. The relevant device programming window will be shown on the right (every device has the dedicated programming window).

For the detectors (see figure 22);

in the **First section (GENERAL)**:

- **Enabled:** a tick [✓] indicates that the detector is enabled.
- **Label:** this is for the editable device-label. The system will use the label as the device **identifier**.
- **Address:** in this field you can modify the address of the detector.

OPTIONS section:

LED Blinking: a tick [✓] indicates that the LED detector will flash.

- **Assigned Zones:** each fire detector, Input module and Manual call Point can be associated with 1 of the available software zones (32 for FC501 control panel). If a device goes into ALARM status, the zones it is assigned will also go into ALARM status.

- **Base** In this section it is possible to select the base for the detector (click on available bases).



PROCESSING for WARNING/PREALARM section:

this determines the actions the control panel will perform when the device threshold is exceeded.



- **Use zone settings:** the detector uses the parameters of the assigned zone; if this option is disabled, the Warning and/or Pre-alarm can be manually selected.
- **Prealarm:** the control panel will activate the ALARM delay.
- **Warning:** the control panel will activate a WARNING signal.

Depending on the type of detector: Smoke, Heat, Smoke and Heat, Heat and Carbon Monoxide (CO), Smoke Heat and Carbon Monoxide (Co), will have three sections:

OPERATING MODE HEAT DETECTOR SECTION:



 Day mode-  Night mode for Temperature detector (see table 8), choose the Class of the selected detector.

OPERATING MODE SMOKE DETECTOR SECTION:



 Day mode-  Night mode for Smoke and Heat detectors:

- **Drift Compensation:** Drift compensation effects optical smoke sensors only. It will supply a precise analysis about dust accumulation, and therefore, the alarm threshold will be modified accordingly (false alarms).
- **Default:** for smoke detectors only and for Smoke and Heat detectors only;
- **Enhanced:** for Smoke and Heat detectors only;
- **Sensitivity:** Sensitivity can set: **Low**, **Medium** and **High**.

OPERATING MODE CARBON MONOXIDE SECTION:

 Day mode-  Night mode for Co and Heat detectors:

- **Default**
- **Enhanced**
- **Disabled**
- **Sensitivity**, this can be set to: **Low**, **Normal** or **High**. For the FC460PC detector (Smoke, Heat and Co) can be set to: HIGH IMMUNITY or UNIVERSAL, in the **TRIPLE TECHNOLOGY DETECTION**.

 Click-on  to open or close the relative section of parameters programming

 If a detector linked to an Output or Input-Output Module, is disabled (remove a tick [✓] in the proper section), a window will show to ask confirmation. Click on Detail to see further data.

☞ For the sirens of the FC410LPA/S series and the base FC430LPA/S, in the “Sounder Options” section you can set the tone, volume & frequency of flash of the beacon.

☞ For the sirens of the FC410LPSY/AV series you must also choose the Subtype.

■ Input module parameters programming

Click on an entered Input Module, the relevant programming window will be shown as per the following description.

First section: as per the Detectors section;

Assigned zone: as per the Detectors section;

Second section: select the operating mode style: B, C. There are 2 operating mode style: B, C;

- **B style:** two wire connection mode: the short-circuit condition as an Alarm condition.
- **C style:** two wire connection mode: the short-circuit condition as a Fault condition.

☞ As different styles are selected, the electrical operating diagram changes

PROCESSING for WARNING/PREALARM section: see the same section in the **Detectors parameters programming**.

For the **FC410DDM module** only, it is possible to set the thresholds of gas detection, selecting: **Conventional** (for conventional detectors) or **Gas Source** or **Gas Sink** (for signalling detectors). In addition:

- **LED blinking:** click on to enable/disable signaling LED module.
- **External Power:** click on to enable/disable an external 24Vdc PSU.

■ Output module parameters programming

Click on an entered **Output Module**, the relevant programming window will be shown as per the following description.

FIRST section: as per the Detectors section;

SECOND section: Assigned zone; each Output module can be associated with up to 4 of the 32 available software zones for FC501 panel. An Output module will be activated when any of the zones, where it is enabled, go into ALARM status.

Base: in this section the base for the Output module can be selected; click-on available bases (for FC430SAM and FC430SAB only).

Beacon: Activate the blinking or glowing (ON).

THIRD section: Trigger points, each output module can be assigned to 3 Activation points : in this case the Output Module is activated when at least one of the Input points to which it belongs is in a alarm status, indicate:

- the loop the device is connected to;
- the device address.

FOURTH section: Options, these options will allow you to select the conditions that will activate the output module:

- Zone warning, Zone fault, Zone Prealarm, Zone Alarm, Zone Double Knock, Zone Test;
- Point warning, Point fault, Point Prealarm, Point Alarm;

- Panel warning, Panel fault, Panel prealarm, Panel alarm,
- Network fault.

It is also possible to program the Output Module as: **Silenceable**, **Double Knock** and **Walk test**.

- **Linked Delay:** see the same option in the paragraph “Panel Output Programming”.

■ Multiple Input-Output Module - Parameters Programming (FC410MIO/FC410QIO)

Click on an entered **Multiple Input/Output Module** FC410MIO (3 Inputs and 4 Outputs Module) or FC410QIO (4 Inputs and 4 Outputs Module), see the customized Manuals, the relevant programming window will be shown.

The options descriptions are as per the Input and Output Modules paragraphs. In the field “Label” a description of Input/Output Module will be inserted.

For Trigger Points see same section on “Output module parameters programming”.

OPTIONS section:

- **Oppo interface: ActUnit/KeySafe**, allows you to manage the procedure for the automatic opening of the doors of the factory / Office / Shop, Warehouse, in case of fire. This avoids the breakage of these structures. The outputs of this module can control these actions.

- **LED blinking:** click on to enable/disable signaling LE. The **FC410TSM** Door Control Module (one Input/one output) designed to close a fire door in case of alarm or fault. The FC410TSM monitors:

- the external Power supply;
- Loop voltage Test, if the relevant option are enabled.

☞ In an eventual connection on the right side (2 wires connection), the module enables the yellow (isolator) LED blinking (Not correct installation)

■ Manual Call Point parameters programming

Click on a **Manual Call Point** (FC420CP, FC421CP) the relevant programming will be shown as per the following description. GENERAL section: as per the detectors;

OPTIONS section:

- **assigned zones:** each Manual Call Point can be associated with 1 of the available software zones (32 for FC501).

- **Led blinking:** if this option is enabled, the Manual Call Point LED will blink every Loop scanning.

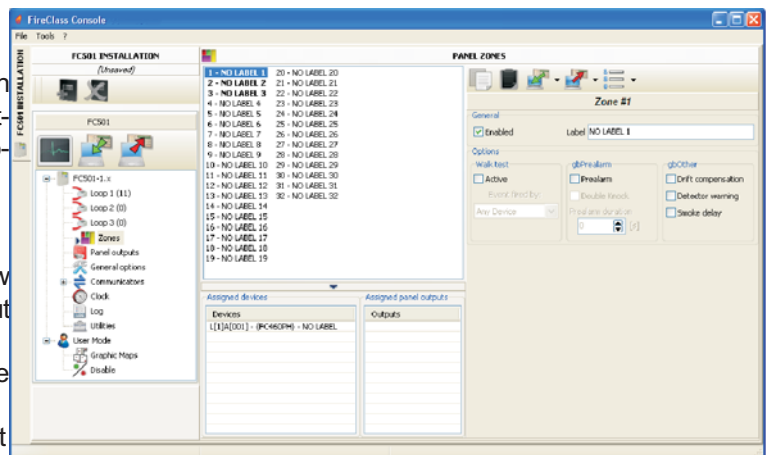

Figure 25 Zones Programming window.

Zones programming

The **Zones** option from the panel tree menu will allow you to access the software-zone parameters (see Figure 25). The software zones parameters will be applied automatically to all the devices associated with the zone concerned.

GENERAL section (FIRST section);

- **Enabled:** a tick [✓] indicates that the zone is enabled.
- **Label:** this is for the editable device-label (up to 20 characters). The system will use the label as the zone **identifier**.

OPTIONS section: a number of parameters can be programmed in this section.

Walk test:

- **Active:** if this option is enabled, the zones in alarm status will activate the programmed Outputs with Walk test event, while the control panel will not generate an alarm. Select if the event is fired by:
Any device means Modules + CP + Detectors,
CallPoints means CPs only,
Detectors means Modules + Detectors (No CPs).

Prealarm:

- **Prealarm:** if this option is enabled, the control panel will activate the ALARM delay.
- **Double Knock:** if this option is enabled and the zone is in Prealarm status, when an other devices (other address) associated to this zone are activated, the zone will immediately generate an Alarm status.

☞ if "Use zone settings" option is not checked for a device, it means that you can individually decide, for that device, if it has to process Warning and/or Prealarm. Once you have decided that the device processes prealarm, its activation will cause Prealarm of the panel (with panel prealarm time) and, because it belongs to a zone, that zone will go into the prealarm status. If another point belonging to the zone goes into Prealarm, the Double Knock option becomes active if enabled in Zone programming page.

- **Prealarm Duration:** an input device programmed with Prealarm time will generate ALARM status when the prealarm time elapses. (see parameters programming detector).

Select the Prealarm time.

The prealarm time can be set from 0 seconds to 300 seconds in 1-second steps. **Other:**

- **Drift Compensation:** see the same option in "Parameters detectors Programming";
- **Detector Warning:** if this option is enabled the control panel will activate a WARNING signal. N.B. To activate the Warning option for a Module, tick the corresponding box on the Module programming screen.
- **Smoke delay:** for each zone, you can program the delayed activation of the smoke detectors. The SMOKE DELAY (60s/30min) parameter, when set, applies to all smoke detectors assigned to the selected zone the alarm verification algorithm as described in the EN54-2, (see page 50).

☞ Under the list of Zones (Zone Programming page, see figure 25) two windows are displayed which devices and what outputs are enabled on it. If you click the right mouse button on a Device in the list, a new menu will be displayed. Selecting Device Details will open a new window, where it is possible to see what points and what output is assigned to the device.

In the section **COMMUNICATORS:**

PSTN: each zone can be associated with one or more voice messages linked to an Alarm, Pre-alarm, Start-up, Breakdown or Walk Test event; these may be sent to a maximum of 32 telephone numbers.

IP: see PSTN above.

☞ The Communicators section will be activated after that the PSTN and/or IP communicator are enabled (double clicks) in the General Options page.

Outputs Programming

The **Panel Outputs** option will allow you to access the outputs parameters. The relevant programming will be shown as per the following description (see Figure 26).

■ SC1, SC2 Outputs

Supervised/Silenceable/Bypassable (Disabled) Alarm Outputs.

Output ACTIVE: positive pull-up to 27.6 V on the [+] terminal; negative pull-down to 0 V on the [-] terminal.

Click on an Output, the relevant programming window will be shown:

In the **GENERAL section:**

- **Enabled:** a tick [✓] indicates that the Output is enabled.
- **Label:** this is for the editable Output-label. The system will use the label as the Output **identifier**.

In the **ZONES section:**

each Output can be associated with up to 4 of the available software zones (32 for FC501 fire panel).

In the **TRIGGER POINTS section:** each Output can be associated with 3 Input Points. If any one of its Input Points goes into ALARM status, the Output will activate. For each Point it is necessary to indicate:

- the address,
- channel of selected device.

OPTIONS Section: these options will allow you to select the conditions that will activate the **outputs**; example: if "Zone warning" option is enabled, the

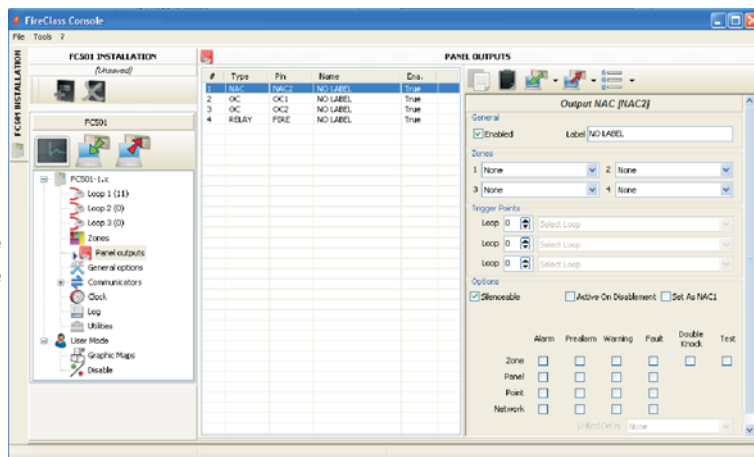



Figure 26 Outputs programming window.

control panel will activate the output when one of its associated points goes into Warning status.

- Warning Zone, Fault Zone, Prealarm Zone, Alarm Zone, Double knock (see Zones programming), Walk Test Zone;
- Point Warning, Point Fault, Point Prealarm, Point Alarm,
- Panel Warning, Panel Fault, Panel Prealarm, Panel Alarm,
- Set as SC1

If this option is enabled, the SC1 output is transformed into a SC FIRE output (it is activated in the event of an alarm and cannot be programmed). It is a C-type output (EN 54-1).

 When **Set as SC1** has been enabled, the SC1 output LED **blinks** if the SC1 output breaks down; it remains **Glowing** if the SC1 output is disabled.

- **Silenceable** The output, if activated, can be Silenceable by checking this option. In the case of output silenceable, once silenced, it will be automatically reactivated in the case of a new fire event.
- **Active on Disablement** Click on this option to activate the programmable SC outputs when any part of the system is disabled.
- **Linked Delay** One of the 5 available timers (set using the General Options page on **Delays Thresholds**) can be associated with an output activated by a zone, point or control panel alarm. The output will be activated by the programmed event, after the delay indicated by the Timer.

■ OC1, OC2 Outputs

These are programmed, NON-SUPERVISED, non-silenceable, bypassable (Disabled) outputs.

These are normally-open terminals (open-collector) which close to ground when the corresponding zones go into alarm status. These terminals will remain closed to ground even after the generating event has ended. See the common parameters descriptions as per SC1, SC2 Outputs.

- **Backup PSTN line** For the output OC1 ONLY, selecting this option and having a secondary communicator connected, in the case of malfunction of the PSTN, this output can manage the secondary communicator.

The **Options** section contains parameters for setting the conditions to activate the outputs (see same section in the SC Outputs paragraph).

■ Relay Outputs

- **Relay FIRE** Non-supervised **Fire** output. Dry contact relay for non-supervised devices:
- **Relay FAULT** Non-supervised **Fault** output. Dry contact relay for non-supervised devices.



 *EN54-2 certification applies ONLY when FAULT output is not J (EN 54-1) type, therefore this output MUST NOT BE UTILIZED to manage Fault transmission devices.*

The **Options** section contains parameters for setting the conditions to activate these outputs (see same section in the SC Outputs paragraph).

General Options programming

The Panel parameters can be programmed through the **General Options** page (see Figure 27).

In the **General section**  :

- **Loop Wiring**: select a **2 wire** connection or a **4 wire** connection for the Panel Loop configuration.
- **Day/night Mode**: select the operation mode: **Day Mode** , or **Night Mode**  : or click-on **Automatic** to set the time (hour and minutes) of transition from one mode to another.
- **Power Supply**: select the Power Supply of the system: BAQ35T24 or BAQ60T24.
- **Disabling**: Disable SC1
 - Allows disabling of the SC1 output (enabled by default). This Output is programmable; it is activated every time the control panel goes into ALARM status.
- **Disable Re-activation on new alarm**. If this disablement is set, then reactivation of the SC1 output on a new alarm will be prevented.

In the **USERS section**  : in this section it is possible to change the installer code and user code. Each code must be 5 digits; the digits from 0 to 9 are allowed.

- **PANEL USER AND INSTALLER section**: this section will allow you to change the **Installer** and **User** codes. Codes with 1 to 5 digits (0 through 9). Installer code allows you to manage the 3 access Levels of control panel: L1(View), L2 (User), L3 (Installer).

The **default installer code** is **00000**:

a click only the password is present,

a second click the installer password is enabled.

- **User code** allows you to manage 2 access Levels of control panel: L1(View) and L2 (User).

The **default User code** is **11111**:

a click only the password is present,

a second click the user password is enabled.

- **Lock Installers Password**: if you select this option it is not possible to perform the procedure to change the password Installer from the panel User Interface: Program Menu, 0=L3 PWD Key.

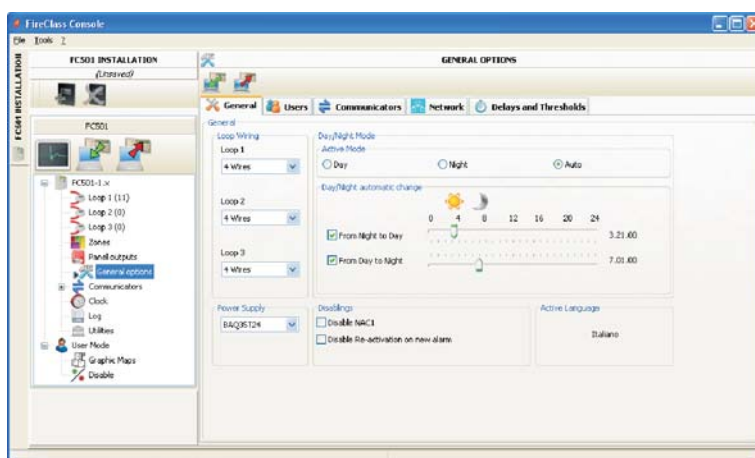



Figure 27 General Options window

In the **COMMUNICATORS** section  it is possible to enable the PSTN functionality and the FC500IP module.

PSTN section:

- a click only the PSTN is present, but not enabled;
- a double click the PSTN is enabled.

When PSTN is enabled you can also select whether to enable both events, alarm and fault or one of two.

IP section:

- a click only the FC500IP is present, but not enabled;
- a double click the FC500IP is enabled.

When IP is enabled you can also select whether to enable both events, alarm and fault or one of two.

In the **NETWORK**  section: a tick on:

- **Enable Network** to enable the network;
- **Allow buzzer silence** If this option is enabled it is possible to silence a device that is activated in every part of the network.
- The **Network Repeaters section** and **Network MFI section** allows you to enable Repeaters and FC500 MFI modules. A click only the Repeater and FC500MFI are present, but not enabled; a double click are enabled.
For FC500MFI module see the programming from the panel at page 52.

 *The Repeater address can be inserted from the panel (see Programming from the panel).*

DELAYS and THRESHOLDS section  In this section it is possible to program:

- The **ALARM DELAYS**: it is possible to choose 5 timers; in the Panel Outputs page, selecting the output, the timer will be set in the Linked Delay option.
- The **PANEL DELAYS**:
- **Investigation Time**: a **Delay** will be added automatically to the Prealarm remaining delay, when the **Investigate** Key will be pressed.

 *The sum of **Investigation Time** and **Prealarm Time** must not exceed 10 minutes*

Fault delay: this field controls how long it takes for the panel to signal a Mains failure. the Amber signalling LED (Power Supply Fault) will be ON, the relevant event will be shown on the display.

Prealarm duration: an input device programmed with Prealarm time will generate ALARM status when the prealarm time elapses.

Prealarm status is signalled by: an audible signal emitted by the control panel;

- blinking on the PREALARM LED (this LED is on the Repeater FC500REP only);
- the message on the display;
- activation of outputs with programmed Prealarms.

Silence duration: when the control panel is in **Night Mode** the Silence delay is the maximum silence time of the Outputs.

Reset: program the Reset time (min Time: 2 sec; max Time: 15 sec.).

The **THRESHOLDS** section is reserved for the DDM Gas Detector;

- **SET**: allows you to choose between 4 levels of threshold. In the section SET VALUES, the relevant defined values are connected to the chosen threshold. After the DDM Gas device is selected in the loop, set the same level threshold.

Communicators Programming

The Communicators page is for programming the parameters of the PSTN interface, of the FC500IP module and of Panel events, as described below.

PSTN interface The PSTN interface section is activated, after the PSTN Telecom interface has been enabled on the **General Options** page (**Figure 27**).

In the **OPTIONS** section:

- **Call attempts** – Set the maximum number of attempts that the PSTN interface makes for each Telephone Number: set from 1 to 9, the default setting is 3 attempts.
- **Iterations** – Set the number of times the PSTN interface repeats the Voice Message: set from 1 to 9, the default setting is 3;
- **Tone Check** – If enabled, the PSTN interface controls whether it could obtain a **Dialling Tone**, if it could obtain it move to the next step, otherwise it will consider the phone call failed, hang up and try again;
- **Call All Telemonitoring** – If the **Call all Telemonitoring** numbers option is enabled, the PSTN Interface calls all the numbers which have been programmed for the event which has occurred, up to the time when all telephone calls succeed or, at the most, for the number of Call Attempts which has been programmed. If the **Call All Telemonitoring** numbers option is disabled, the PSTN Interface will interrupt the call as soon as it succeeds.
- If the **Call All Voice Messages** numbers option is enabled (default setting), the PSTN Interface will call all programmed numbers for the event which has occurred,

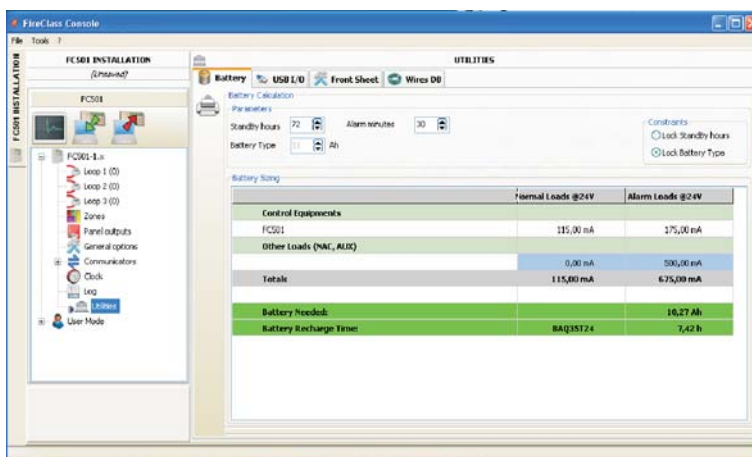

Figure 28 Utilities window

until all phone calls fully succeed according to the number of Call Attempts which have been programmed. If the **Call All Voice Messages** numbers option is disabled, the PSTN Interface will interrupt the calls as soon as one is successful.

In the section **PLAY MESSAGE AFTER**, sets the condition for the playing back of the Voice Message.

- **Dialing** - the Message is played back as soon as the Telephone number is dialled.
- **Voice** - the message is played back when the PSTN Interface detects a voice answer.
- **Delay** - the Message is played back when the programmed Delay elapses after that the Telephone number has been dialled: the Delay could be set from 0 up to 99 seconds, with 1 second steps; the default setting is 0 seconds.

In the section **SUPERVISION**: sets the parameters corresponding to the **Period Test**, as described below:

- **Date and Time First Test** – Set the date and time for the first Periodic Test.
- **Period** – Set the interval between two Periodic Tests: the interval can be set from 1 up to 25 hours, in steps of one hour; the default setting is 24 hours.

 *The Periodic Test event IS NOT recorded in the Events Log.*

The section **ADDRESS BOOK**  is used to program the telephone numbers that can be used to send:

- Voice Messages** (Dialler function) or
 - Telemonitoring** data,
- when the events, recognized by the panel, will occur. In the case of **Telemonitoring**, select: the type of protocol (SIA, ADEMCO Contact ID) and: Customer Code.





Phone numbers are:

- only for alarms;
- only Faults,
- and numbers of general use.

In the section **VOICE MESSAGES**  parameters related to voice messages are programmed, as described below.

(1-7) MESSAGES – These messages (from 1 up to 7) are NOT editable.

(8-32) MESSAGES – In this section, a description of 20 characters max, can be assigned to messages from n. 8 n. 32.

-  Allows to listen a present message.
-  Allows to stop the message playback.
-  Allows to delete the selected message.
-  Allows a voice message to be recorded via the microphone on the PC (max 6 sec., Header message 12 sec.).
-  Allows to import an audio file (mp3, wav) to be used as a voice message (max 6 sec.).

 *The USB memory stick is the ONLY way to download in the panel the AUDIO files*

IP interface The **IP interface** section is active after the module FC500IP has been enabled in the **General Options** page (Figure 27). The IP module programming is in 3 sections: **OPTIONS**, **ADDRESS BOOK** and **ADVANCED**.

OPTIONS:

DHCP – Select this option if you wish to use a dynamic address for the IP Module you are programming.

- **IP static**– Select this option if you wish to assign a static IP address to the IP Module you are programming, then set the following parameters:

- **IP address**: enter the IP address to be assigned to the IP Module; the network administrator will provide you with this information. The default setting is 192.168.0.101.

- **Subnet mask**: this must be the same as the subnet mask for the local network; only one subnet mask is valid for each local network. All nodes on the same subnet will use the same subnet mask; the network administrator will provide you with this information. The default setting is 255.255.0.0.

- **Gateway IP address**: enter the IP address of the local gateway which may be used by the IP Module to connect to a PC outside the LAN (WAN). The default setting is 0.0.0.0.

Ethernet speed

This section is used to set the parameters corresponding to the Ethernet interface of the IP Module: the Auto setting is selected by default.

➤ **Auto** – If this option is enabled, the IP Module will take the speed and duplex values from the network. If this option is disabled, the speed and duplex values must be set as described below.

➤ **Speed** – If the Auto option is disabled, set the speed value as appropriate: **10 Mbps** or **100 Mbps**.

Duplex – If the Auto option is disabled, set the Data exchange (Duplex) mode as appropriate: **Half** or **Full**.

Read-only options

The values in this section cannot be modified. They display information relating to the connected IP Module.

➤ **MAC Address** – Displays the MAC address of the IP Module: the MAC address is a unique identification number assigned to every IP device throughout the world.

➤ **Software version** – Displays the version of the program running on the IP Module.

➤ **Boot version** – Displays the boot version.

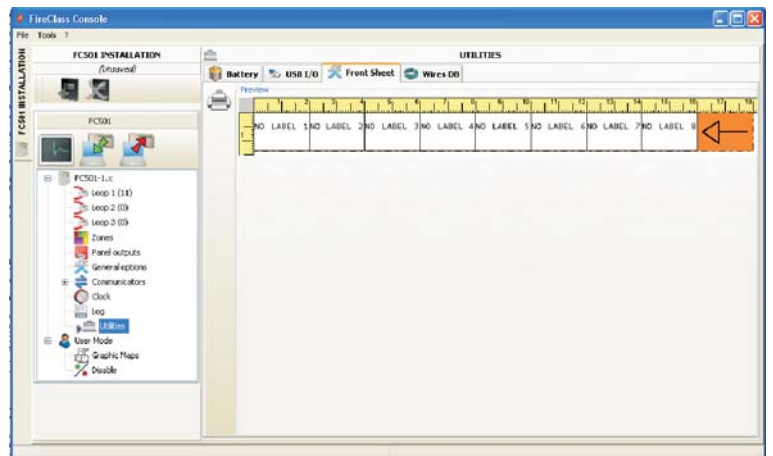

Figure 29 Page to print the zones label.

Current IP address – Displays the IP address assigned to the IP Module.

General options This section is used to select the general options for the IP Module.

Encryption key – If it has been programmed, the IP Module will use this key to encode and decode the packets exchanged with the PC. The encryption key may include between 1 and 32 hexadecimal characters (numbers 1 to 9 & letters A to F). To disable encryption, enter 0 (zero). If the encryption key does not correspond to that of the IP Module, communication between the PC and the IP Module will NOT be permitted. The default setting is 0 (encryption key not enabled).

Board port – This is the port which should be used to communicate with the IP Module. The default setting is 3064.

Pass Through port – This is the port which should be used to communicate with the control unit. The default setting is 3062.

Board code – This code should be applied when the FireClass Console is used to program the IP Module, either remotely or locally. The code should consist of 4 hexadecimal digits. The default setting is 5555.

Idle Connection Timeout – Enter the maximum time period during which no data is transmitted before the connection is terminated. The default setting is 20 seconds.

ADDRESS BOOK

Account Code – The account number is used by the central station to distinguish between transmitters. There is one account number programmable for the FC500IP. Default value: (0000FFFFFF).

Account codes 0000FFFFFF,FFFFFFFF and 0000000000 are not valid accounts.

➤ **Supervision**-To enable Supervision mode, tick this option.

Main

➤ **IP_Address** – Static IP address for the receiver. Program the IP address of the central station receiver. If an IP receiver is not connected program 0.0.0.0 address. Default value: 000.000.000.000.

➤ **Local Port** and **Remote Port** – These values show the ports to communicate with receiver. The same receiver supplies these values. Default values:3060 (**Local Port**) and 3061 (**Remote Port**).

Backup

➤ **Receiver IP** – Static IP address for the second receiver. Program the IP address of the second receiver. Default value: 000.000.000.000.

Receiver will be used for backup only; not checked.

➤ **Local Port** and **Remote Port** – These values represent the ports to be used for communication with the backup receiver. Default values: 3065 (**Local Port**) and 3066 (**Remote Port**).

Third

➤ **Receiver IP** – This is the IP address assigned to the receiver of the domotics system with which you wish to interact. It is supplied by the receiver itself. Default value: 40000.

Local Port and **Remote Port** – These values represent the ports to be used when communicating

with the domotics system receiver. They are supplied by the receiver itself. Default value: 40001.

The receiver will be used for the domotics system only; not checked.

ADVANCED

LED Trouble mask / Output Trouble mask.

This section can be used to enable/disable signals from the OC output and the indicator light, for certain events recognised by the IP Module: **Network Absent**.

A tick indicates that the corresponding event will be signalled! The LAN not detected event indication is enabled by default.

Output polarity. This section is used to set the operating mode of the OC output on the IP Module.

➤ **Open on trouble** – The outlet is suspended when a breakdown occurs (default setting).

➤ **Close on trouble** – The output is connected to the earthing system when a breakdown occurs.

For the IP module, the procedure to “restore to the

factory defaults”, use the  icon in the **Advanced** section. In the same section, **Advanced**, can be found the

button to upgrade the firmware  and the

button  to reset the FC500IP board.

For an explanation of the further parameters and the programming, see the dedicated manual of the FC500IP module.

Events

In this section , for each event recognized by the Panel, it is possible to program: the telephone numbers to call, the Voice Message and the Events code to be sent. The Alarm, Prealarm, Warning, Fault and Walk Test events can be sent to up to 32 telephone numbers. The telephone numbers are set in the

ADDRESS BOOK section . It is also possible to set

the type of phone call: Voice  or Telemonitoring 

or for IP communicator .

There are these options to use the voice messages:

1)- record them directly on PC or import present messages on PC using the functionality of the buttons in the **Messages** section;

2)- first: importing them on PC from an external source,

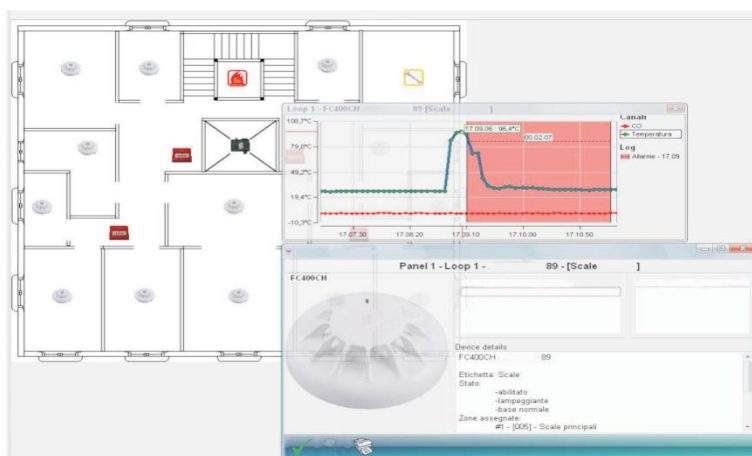



Figure 30 Example of the graphical maps

a USB stick, second: upload them, using the functionality of the buttons in the **Messages** section.

 *To load the voice messages in the Panel it is necessary to use the USB connector on the motherboard and to start the Programming procedure of the Panel by User Interface (see Programming from the Panel, 7 KEY -USB-.*

CLOCK

The Date/Time option from the CLOCK menu is for the control panel clock settings.

Enter the required Time and Date.

Schedule the automatic application of summer time if required. The button  will change the daylight saving to the default values.

LOG

This option allows to read the Log stores events.

Description of the icons in the LOG bar:



Up load from Board: click on this icon to upload the LOG of the connected control panel.



Export LOG to file: click on this icon to export the LOG in a (*.fcl) or (*.xml) or (*.xmc) file.



Import LOG from file: click on this icon to import the LOG from a (*.fcl) or (*.xml) or (*.xmc) file.



Apply filter: click on this icon to select the LOG filter (if necessary):

➤ Enabled/Disabled/Restore/Alarm/Prealarm/Warning /Fault/Generic/Walk test

If required set other filters for the Event Log:

➤ Filter by panel/Filter by Loop/Filter by device /Filter by zone.



Print a text file; in this case the control panel Event Log, or part of it.

The following data will be stored in the LOG: the Event's **Number**, the **Date**, the **Time**, the **Class** (Fault, Alarm, Warning, Generic and Walk test), the **Event's description**, the Control panel **number**, the **Loop**, the **Device type**, the **Status**, the **Threshold** and the **Zone**.



Clicking on this icon will delete the Event Log.

UTILITIES

In the **Utilities** page, it is possible:



shows the calculation of the batteries (see next dedicated paragraph);



enable a USB stick both to load the firmware, voice messages, panel programming, then  download the data of a customer;

 *Clicking on "Override" now it is possible to change the panel ID for export/import, and if also the option "Any Panel [XXXX]" is implemented it is possible to utilize this configuration in any Panel (e.g. to load same voice messages in several panels)*



Load the label of the first 8 zones, which should be printed and inserted in the transparent window in the User Interface (see Description of the parts);



clicking on this icon for printing a pdf file containing descriptions of the first 8 zones. The size of the front label is predetermined and can not be resized (see Figure 29).



Set in the Printer driver, into "Page resizing" the option "None"



Import the type of wiring (from a database) for use in various connections Loop and so these type of wires will be used in the **Loop wire calculation** (see same paragraph). (see Figure 24).



The database can be moved from one system to another. The Console searches for the wire database while starting, so, if the user cannot access a moved database, simply close the software, and start it again.

■ Battery Calculation

The Battery calculation window allows you to see (Figure 28):

➤ the FC501 Loads,
➤ the Loop1, Loop 2, Loop3 devices loads,
in the condition of **Normal Load** and **Alarm Loads** (percentage of devices in alarm status), when the Mains fails. Below this window, in the option "Others Load", if needed, the Loads on Auxiliary terminals will be inserted. Automatically the **Total Load**, the **Battery needed** and the **Battery Recharge Time** will be shown.

Set the **Stand-by hours**, **Alarm minutes** values and the calculation will be done.

Battery calculation Parameters:

➤ Stand-by hours (From 1 to 144 h)
➤ Alarm minutes (From 1 to 240 m)

Battery Type: this is the battery (Ah) arising from calculation.

Battery calculation constraints:

➤ Lock stand-by hours
➤ Lock battery type.

Lock stand-by hours: "Battery Type" value (Ah) will be calculated, fixed **Stand-by hours**, **Alarm minutes**;

Lock battery type: "Stand-by hours" value will be calculated, fixed **Battery Type** (Ah), **Alarm minutes**.



The software calculation is a rough calculation and cannot substitute the Installer and/or Qualified person calculation.



Print a text file; in this case the calculation used to determine the loop charge and establish the type of battery required.

User mode

If the option "**Installer Mode**" is enabled, with the use of the Installer password, is now possible to program/change the installation. If the option "**User Mode**" is enabled this feature shall allow the user to perform the real time monitoring of the panel zones and the loop devices associated to them. The loop device or zone is displayed in a way that immediately informs the user about its state with

a coloured background, an overlapped icon, etc. Selecting the loop device the user can also get real time information about the last measured value (that can be expressed in °C, ppm, %, V, etc., depending on the device type).

While the FC501 Console is running, the user can choose whether to work in **Normal mode** of communication (communication with the panel takes place only when required), or in **Real Time mode**.

The communication in Real Time mode is activated by

the button , and start a session of continuous communication with the control panel.

While the FC501 Console is in Real time mode, it constantly receives data from the panel, and provides the user with feedback on the changes of status of the control panel. The communication in Real Time mode provides the user with two additional controls: **Events in real time**, and **Remote control**.

The **Event log** in real time is similar to that found in the "Event Log" page, but it is updated constantly, and always shows the last 16 events generated by the control panel. The **remote control** panel is used to send commands to the Fire Panel as if a graphical interface were being used. This feature will allow the user to remotely press the functional buttons that are present on the panel user interface:

- Silence, Reset, Investigation, Lamp test, Silence Buzzer, Evacuate.

The sending of a remote command to the panel through this interface will require the SW User to insert the panel's User or Installer password for security reasons.

A control keypad will be shown to request the password when commands are sent to the fire panel. The remote control panel also shows the detailed status of the connected fire panel, and provides a ready visualization of status changes.

A second click on the button , ends the communication in real time mode and returns to normal mode.

The User mode provides the use of Graphics Maps. The activation procedure follows.

- 1) First, it is necessary to create the tree structure to

contain the Graphics map. Click on the icon  and define the first map/background, click on the icon

 to import it.

 *The system of **Graphic maps** allows the use of vector graphics file (WMF) as well as the more traditional bitmap formats (BMP, JPG, GIF, PNG).*

This is the map that will be shown in the condition of absence of events.

- 2) Do the same for more level of maps and insert in each node of the tree structure its plan (e.g. the picture of the building, the floor where the system is installed and the installation plan).

- 3) Use the icon  to delete any map/structure.

- 4) Insert the devices on the maps; after the map has been selected, click on the name of the installation, in the same window, under the tree. A list of all devices on the loop will be shown. At this point it is sufficient

to drag the selected device in the relevant position on the map in question.

- 5) The final map consists of a series of separate pages linked together and easily accessible with a few mouse clicks, or by accessing to the tree diagram.

 *The Graphic Map, in Real time, is shown in a dedicated window. It is possible to analyze more than one device at a time, but each new image requires additional system resources. Consequently, to analyze more than four devices simultaneously is inadvisable*

In Real-time mode, the Graphic map is normally shown in stand-by status (first map/Background).

- 6) When the fire panel detects and reports a changed status of detector or module, the FC501 console replaces the icon of the detector with the icon of the event (Fire Alarm, Fault, etc.).

- 7) The FC501 console activates the Graphic map where the detector/module has changed status. Through the connection between the activated map and the first map/background of higher level, the area associated will blink.

- 8) Use the icon  to realize the drawing of possible areas, that will blink when the contained devices will be activated. To close the area: a double click using the Dx button.

- 9) Use the icon  to delete any devices or areas, after they are selected.

For more info about the functioning and use of Graphic maps, follow the Help, accessible both by main menu and by the Graphic maps.

Disable

The Disable page (click-on this icon)  is available only when the FC501 Console communicates in Real Time. By the FC500IP module connected via network or serial port on a computer, it is possible to see the status of the FC501 panel in real time.

The items that can be disabled are: devices, the Panel outputs, zones, Devices in the network: Repeaters and FC500MFI modules.

Use the buttons located above every list to disable selected items in the list. Before sending a Disable command, the FC501console prompts to enter the User or Installer password.

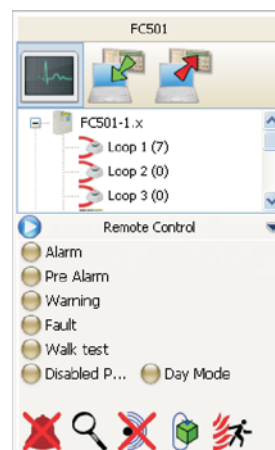

Figure 31 Remote Control display

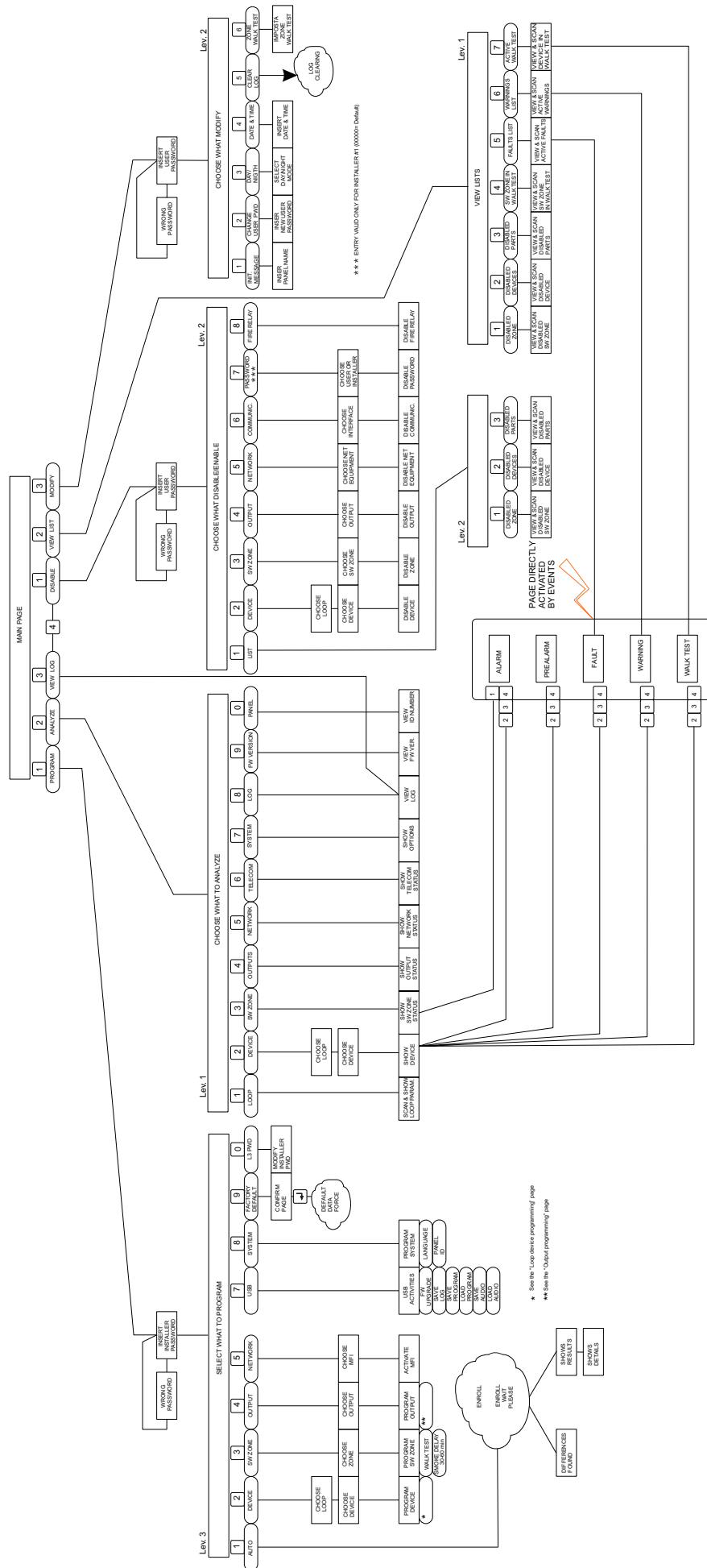

Figure 32 Diagram of all possible operations from the panel, L1, L2 and L3 Levels

PROGRAMMING FROM THE PANEL

Read through the following section carefully, in order to get an overall view of how to use the User interface Programming (Main panel) of control panel. For details regarding the parameters of each phase, refer to the respective paragraph in the "PROGRAMMING FROM A PC" chapter.

Using the system

The FC501 system can be managed from the User interface (main panel) and/or through the FireClass Console application. The User interface (main panel) allows access to different authorized Level .

There are three different access levels, as follows.

L1= First Level: this level allows the Reading of Parameters ONLY:

-**ANALYZE** button (see Figure 32) **views** the status of the: LOOP, DEVICE, SW ZONES, OUTPUT, NETWORK, TELECOM, OPTIONS, LOG and the FW Vers.;

-**View LOG**;

-**View Lists** button **views** the lists of: DIS. ZONES, DIS. DEVICES, DIS. PARTS, WALK TEST, FAULTS, WARNINGS and Dev. in TEST.

L2= Second Level or USER Level: access to this level requires entry of the USER PIN (Access Level 2).

This level allows all the operations of the First Level, but also allows you to **MODIFY**:

-**MODIFY** button for: Init MSG (MESSAGE), L2 USER PASSWORD, DAY/NIGHT, TIME and DATE, CLEAR LOG and ZONE WALK TEST ;

-**DISABLE** button for: DIS LISTS, DEVICE, SW ZONES, OUTPUT, NETWORK, COMMUNIC.

L3= Third Level or INSTALLER Level: access to this level requires entry of the INSTALLER PIN (Access Level 3).

This level allows all the operations of the First and Second Level, but also allows you to program the system; the Programming phase allows the installer to program the control panel and peripheral devices (detectors, modules, repeater), in detail:

AUTO, DEVICES, SW ZONES, OUTPUTS, NETWORK, MAP DEVICE, USB, SYSTEM, DEFAULT and PWD L3.

Operating the system from the Panel

To manage the system from the User interface (Main panel) the Alphanumeric keypad, the Cursor keys, the ESC Key & the ENTER key are used.

 *The use of the keypad, cursor keys, ESC key & Enter key is explained in detail in the following sections.*

■ Alphanumeric entry (Editing text)

Use the Alphanumeric keypad to create labels and enter data and codes.

The string must be 20 characters max.

Alphanumeric keypad Each time the alphanumeric key is pressed in the selected position, pointed by the cursor, the characters printed on the key will appear in sequence and cyclically.

1= ABC, 2= DEF, 3= GHI, 4= JKL, 5= MNO, 6= PQR, 7=STU, 8=VWX, 9=YZ.

 *0 key: is used to create a space and to clear the position of used string.*

Cursor keys Use the **UP** key for upper-case letters and the **DOWN** key for lower-case letters.

Use **LEFT** and **RIGHT** keys to scroll along the line, then press the alphanumeric key to insert in the selected position.

ENTER key Once the text has been completed, press the **ENTER** key to confirm and step forward, or in the main page signaling a local programming activity followed by a panel reset.

ESC Key The **ESC** key is used to cancel the operation and to step back to previous page.

 *For additional functionality about the keys use, see the User Manual, Chapter "User Interface".*

 *The following pages show all possible operations managed at **Level 3 (Installer Level)**.*

*The operation managed at **Level L1 and L2 (User Level)** are shown in the User Manual.*

Assistant text composition

To make the entry of text strings easier, an assisted procedure has been included, based on a pre-compiled 128 words (18 char max) vocabulary. When one of the numeric keys is pressed to enter a letter, the first word in the vocabulary beginning with that letter will be inserted. The upper and down arrow will load the next or the previous, respectively, word in the vocabulary. This "assisted entry procedure" is entered or leaved keep pressed the UP key for more than 3s, while pressing for more than 3s the DOWN key the "assisted entry procedure" is leaved and the normal single characters entry is active (see Figure 33). When the "assisted entry procedure" is active the string "Vocabulary ON" blinks on the upper right area of the LCD display. In the "Vocabu-

ENTER key: Accepts the programmed string and the User Interface moves to the next programming parameter page, if any, otherwise returns to the main page signalling a local programming activity followed by a panel reset.

To program each parameters or options inside the system will be used the same page that adapts itself to the most appropriate program mode for the parameter to program.

In the case of wrong value entered, the following message will be displayed for 5s (see Figure 33).

Main Page - Accessing the system

After the Control panel has been installed and powered by the Mains (230V 50/60 Hz), the first time will prompt to choose the language of the display, then the Main Page will be shown as per Figure 35. In this phase:

Alphanumeric keypad Key 1 brings the panel in the “Program” or “Analyze” mode;

Key 2 brings the panel in the “Disable” mode or “View List”;

Key 3 shows the events of the LOG or brings the panel in the “Modify” mode;

key 4 selects between groups of related functions of the keys 1,2, and 3.

Cursor keys The **UP** Key: increase the brightness of LCD display;

the **Down** Key: decrease the brightness of LCD display;

the **Right** Key: increase the contrast of LCD display;

the **Left** Key: decrease the contrast of LCD display.

ESC Key Exit from the main page, moves the User Interface to Front page or event driven page, if any. Pressing the key for more than 3s the panel will be forced to access level 1.

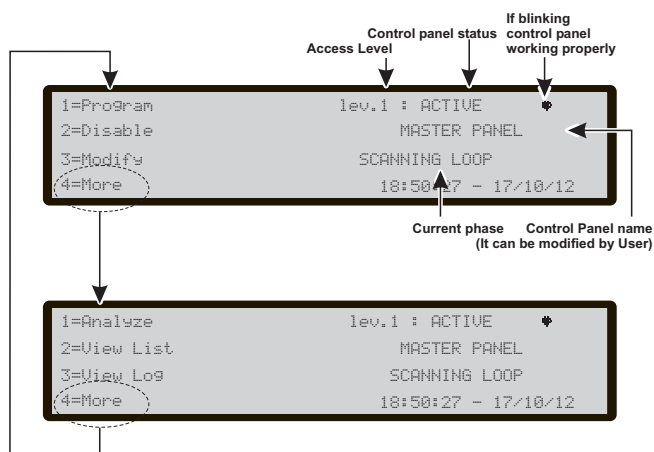

Figure 35 Main page window

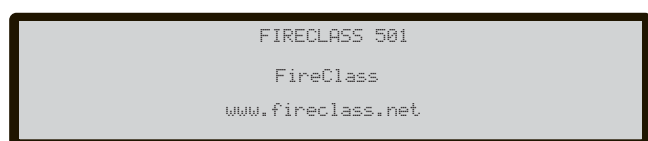

Figure 37 Front page window

ENTER Key No function is related to ENTER key.

When the panel starts its normal activity and no accesses to the User Interface are sensed for a period of 30s, the User Interface leaves the Main page and reaches the Front page. For more features see the description of the MAIN page in the User Manual.

Insert password

From the **MAIN** page by selecting 1 key “**PROGRAM**” the panel will prompt the Installer password to operate at Level 3;

the **default** installer code is **00000**: every digit will be hidden by *(star) symbol.

in this phase (see figure 36):

Alphanumeric keypad Use the Alphanumeric keypad to insert the **5-digit** password.

Cursor keys No function is related to **UP, Down, Right** and **Left** keys.

ESC Key If the entry field for the password is empty: abort the enter password procedure and move back to the User Interface to calling page, otherwise clear the entered digits (clears the entry field).

ENTER key Accepts the password and starts the password verification process. If a Password is wrong or missing, the screen shown in Figure 38 will appear.

To return to the previous screen, press the Esc key or wait for 5 seconds.

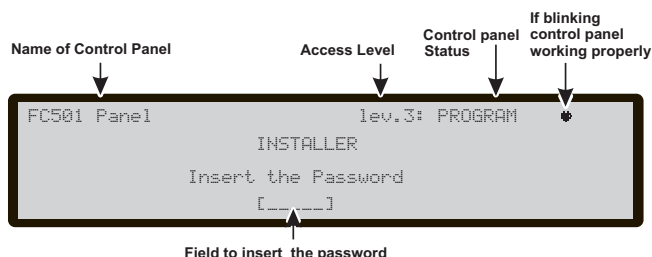

Figure 36 Insert password (Installer code).

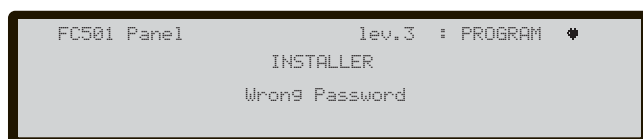

Figure 38 Display Wrong Password

Programming Page

From the MAIN page, use the **1** Key to select the Programming phase. Insert the password (installer code) and then the page, in Figure 39, is shown: in this phase:

Alphanumeric keypad Use the Alphanumeric keypad to select the different programming functions:

0= L3 PWD; start the page to insert the password of L3 level (Installer code) (see **Insert-Modify password** page);

1= Auto: start the auto-learning of the loop devices and the RS485 network devices (Repeater only);

2= FC Dev: start the selection and programming page of the loop devices;

3= SW Zones: start the programming page of the software zones;

4=Outputs: start the programming page of the Outputs;

5= Network: start the programming page of the RS485 network, FC500MFI modules;

7=USB: start the programming page for the management of the USB memory stick;

8=System: start the programming page of the system parameters;

9=Default: forces a default setting restore procedure;

Cursor keys No function is related to **UP, Down, Right** and **Left** key.

ESC Key Use **ESC** key to cancel the operation and to step back to MAIN page.

ENTER Key No function is related to **ENTER** key.

0 KEY - insert Modify password

Inside the PROGRAM page, press the **0** key for the display (see figure 40): in this phase: Installer Code at Default is 00000; every digit will be masked by * symbol.

See the *Installer and User features in relation to the password on page 8*

Alphanumeric keypad Use the Alphanumeric keypad to insert the password of **5** digit. The first digit must be **0** for the installer 1 (Main Installer) and **9** for the next one.

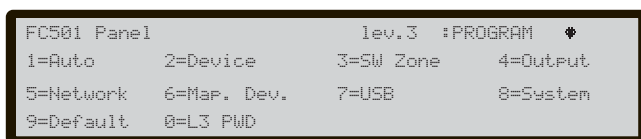

Figure 39 Program Page window

The panel will verify the correct entry of the identification digit, in the case of error a denial tone is generated

Cursor keys No function is related to **UP,Down,Right** and **Left** key.

ESC Key Short press: aborts the enter password procedure and moves back the User Interface to calling page; Long press: clears all the entered digits.

ENTER key Accepts the password and starts the password verification process.

If a wrong or not allowed password is entered, the Figure 40b will be displayed for 5s..

In order to avoid the entering of a duplicated password (two different users/installers with the same password) the users and installers are driven to use a specific digit as first digit of their password, in this way the most significant digit acts as user/installer identifier.

The first digit for USER #1 is: 1

The first digit for USER #2 is: 2

The first digit for USER #3 is: 3

The first digit for USER #4 is: 4

The first digit for USER #5 is: 5

The first digit for USER #6 is: 6

The first digit for USER #7 is: 7

The first digit for USER #8 is: 8

The first digit for INSTALLER #1 is: 0

The first digit for INSTALLER #2 is: 9.

1 KEY- Auto Enrolling (Autolearning)

The **Auto** option from the **PROGRAMMING** menu will allow you to enrol the loop devices and the RS485 network devices automatically (repeater FC500REP only) The **Auto** option consists of three main phases: 1-Auto enrolling, 2- Auto addressing, 3- Devices mapping (see notes on page 55, 56).

Auto enrolling (Autolearning) can be done during the installation phase and after changes of the loop and network configurations.

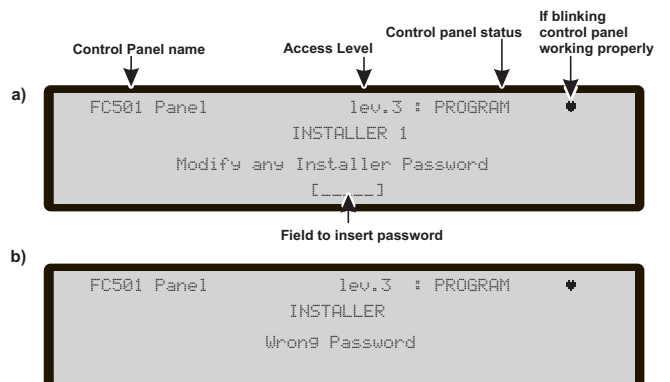

Figure 40 Insert/Modify Password window

Use the **1 Key** to select **Auto** option, the display will show the Figure 41: in this phase:

Alphanumeric keypad No function is related to Alphanumeric keypad.

Cursor Keys No function is related to **UP, Down, Right, Left** Key;

ESC Key Use **ESC** key to cancel the operation and to step back to MAIN page.

ENTER key No function is related to **ENTER** key.

■ Automatic zones assignment

After few seconds: the panel will prompt to choose the type of automatic zones assignment.

This feature allows to assign the zone to each enrolled detector, and define the first trigger zone for the activation of all outputs channels in the enrolled modules.

The possible schemes used to assigned the zones are proposed to the installer by the panel during the enroll process (see Figure 41d):

- 1 = on Loop basis
- 2 = on device address basis
- 3 = no assignment.

Three different schemes are possible:

Scheme 1) all the devices located on loop1 will be assigned to zone 1; all the devices located on loop 2 will be assigned to zone 2; all the devices located on loop 3 will be assigned to zone 3.

Scheme 2)

- From address 01 to address 16 assigned to zone 1
- From address 17 to address 32 assigned to zone 2
- From address 33 to address 48 assigned to zone 3
- From address 49 to address 64 assigned to zone 4
- From address 65 to address 80 assigned to zone 5
- From address 81 to address 96 assigned to zone 6
- From address 97 to address 112 assigned to zone 7
- From address 113 to address 128 assigned to zone 8.

Scheme 3)

All the devices found all over the loop are assigned to zone #0 (system zone).

The previous zone assignment schemes are applied also to the first "trigger zone" in the case of output only devices (sounder, beacon, SNM module) or output channel of Input/output devices.

After the Zones assignment is selected

For devices already addressed (1-128) the zone assignment procedure is that explained above (see Figure 42d). For not addressed devices, if you choose ESC at the end of Auto addressing, the panel assigns the zone based on the loop, but if you choose ENTER the panel assigns the zone based on its address (see table on page 57)

In this phase, the Alphanumeric Keypad only is active:

Alphanumeric keypad used to select the appropriate zone assignment scheme 1÷ 3.

■ Warning Enrolling (Autolearning)

When there are some differences between the present configuration and that of the Enrolling (Autolearning) results, the display will show the Figure 40b: in this phase:

Alphanumeric keypad 1 = delete the old configuration and accept the new one;

2 = To accept only the differences between the new and the previous configuration detected. The new devices will be added, while the devices that are no longer present will be removed. This applies both to the loop devices and 485 network devices;

3 = The current configuration, detected, will be discarded, the previous configuration will still be valid.

Cursor Keys No function is related to **UP, Down, Right, Left** Key;

ESC Key Use **ESC** key to cancel the operation and to step back to MAIN page.

ENTER Key The **ENTER** key activate the device details page. The fields "Loop1", "Loop2" and "Loop3" show if there are any devices connected. In both cases: **Autoscan OK** or **NO**, it is possible to view details on the Loop, Figure 41c). The "RS485net: Rep" show the number of repeaters found on the network RS485.

In this phase:

Cursor Keys The **UP** key: shows information relating to the next Loop;

The **Down** Key: shows the information relating to the previous Loop;

No function is related to **Right** and **Left** Keys.

ESC Key Use **ESC** key to cancel the operation and to step back to MAIN page.

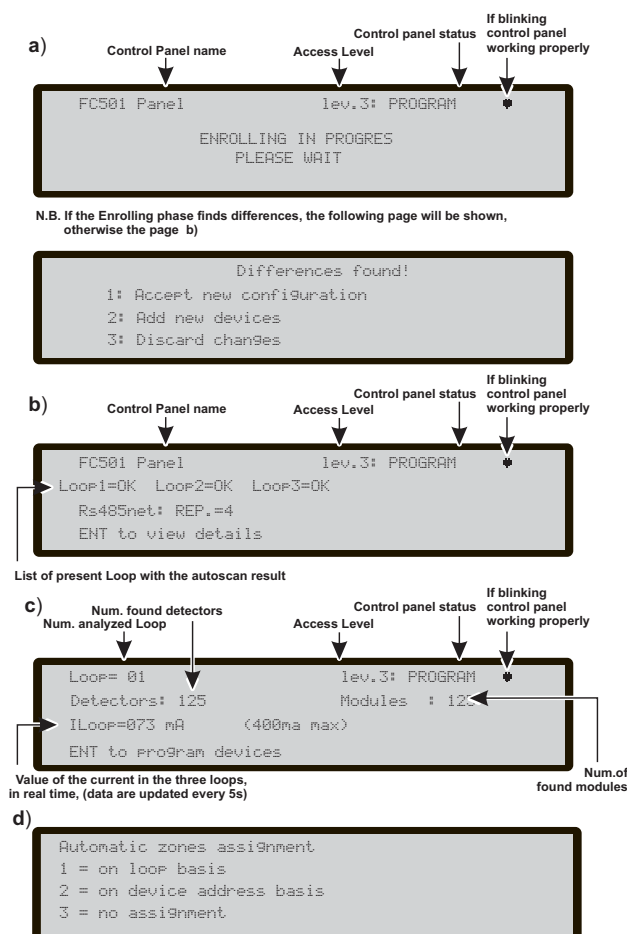

Figure 41 Autoscan results window

ENTER Key The ENTER key accept the device selection and activate the loop device programming.

Attention: when the Enrolling is done, the devices programming data (except their assigned names) will restore to the factory defaults; therefore a previous configuration will be lost (Selection 1).

Auto addressing procedure

For auto-addressing is intended a sequence of operation that allows to the installer to make all the devices accessible by the panel without executing any previous configuration action on the devices, during their installation phase (device acquire phase). This involves for the installer, no longer necessary the use of the FC490ST, the programming Tool of the Loop devices, and consequently is no longer needed the procedure for the manual assignment of the devices addresses. Furthermore the auto-addressing procedure have to be able to allow to the installer to know or set the geographical position of the devices in the site (device mapping phase).

The Auto addressing procedure is part of the loop devices enroll process in the FC501 panel. The loop devices

enroll process is initiated by the installer:
 - press the 1 key to enter in PROGRAMMING mode.
 Enter the Installer PIN (00000) at default, each digit will be masked by * (star).

- Select option 1: AUTO (see notes on page 55, 56).
 After all the devices are initialized in Loop: the panel will prompt to choose the type of automatic zones assignment :

- 1 = according to the Loop
- 2 = based on the addresses of the devices
- 3 = do not assign.

Made the choice, the panel get to the results phase:

- press the ENTER key to activate the AUTOADDRESSING phase;
- or press ESC to the FAULT page (not addressable devices)

By default, any addressable device has the address 255; the fire panel examines the serial number of each device and assigns each an address from 1 to 128.

If the control panel finds a device with a different address than default (255) it leaves the address set at that device.

The control panel is ready to work, at this time, (with the default basic programming)

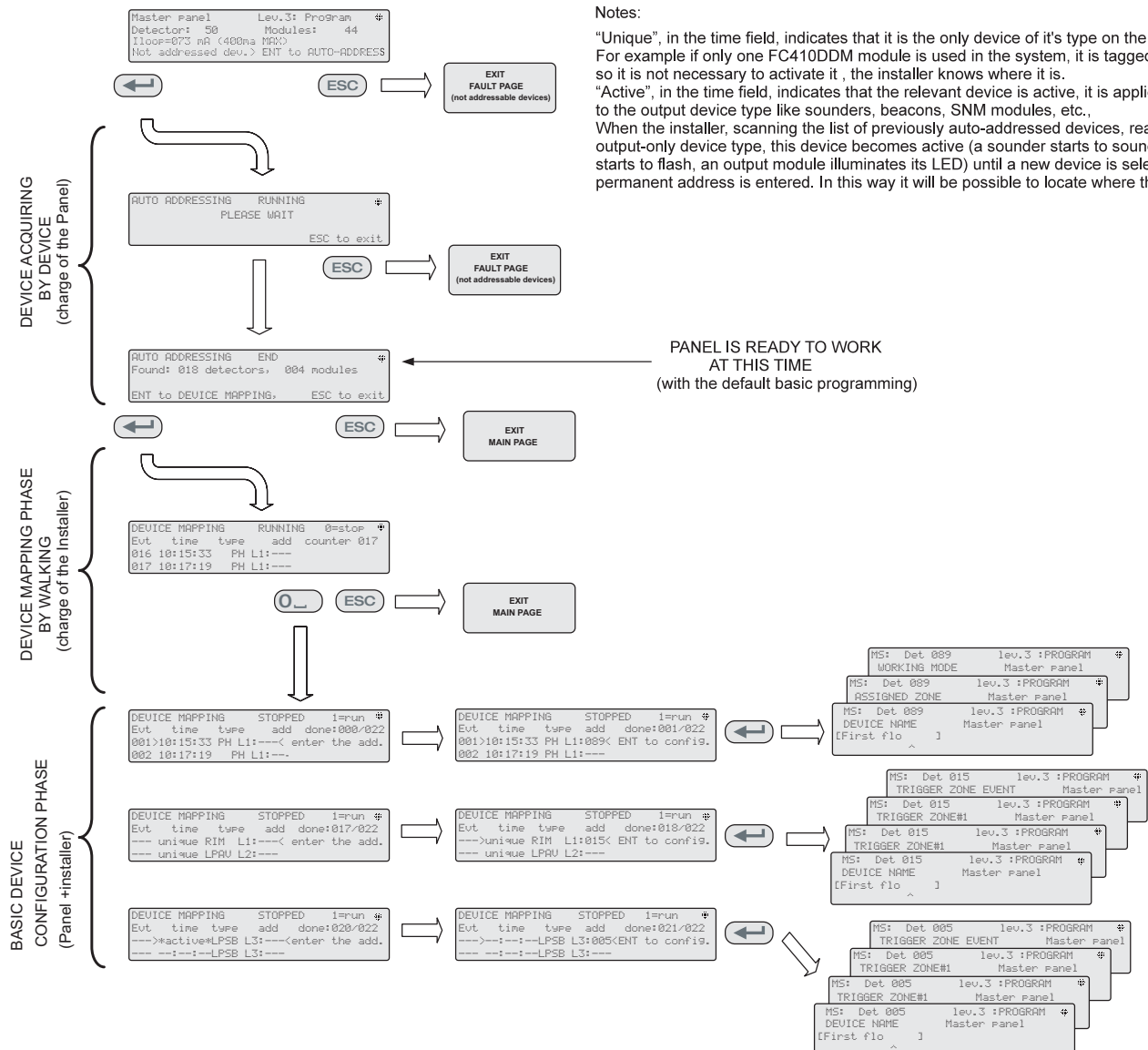

Figure 42 Autoaddressing scheme

If for requirements of the system, the installer wants to set the system:

example set the address 1 to detector 1, address 2 to detector 2, and so on:

- press the ENTER key, so the fire panel initiates the MAPPING DEVICES phase. First phase:
- In this phase, the installer must activate in sequence, moving in the plant, all input devices: detectors, input modules, Manual Call Point, and then return in front of the fire panel.
- Report the sequence of activation on the map of system.
The fire panel will store the activation sequence (even temporarily).
The installer using the User Interface UP and DOWN key will start to examine the first activated device.
- Select the device, the address will blink, so the installer can change the address.
Press ENTER to confirm. At this point the address will become fixed.

☞ If the ENTER key is pressed again, the installer can switch to programming phase of the device in question.

"Unique", indicates that it is the only device of its type on the loop. So it is not necessary to activate it, the installer knows where it is.

Second phase:

In this phase, the installer examines the sounders, the beacons and the output module.

- When the installer, scanning the list of previously auto-addressed devices, reaches an output-only device type, this device becomes active (a sounder starts to sound, a beacon starts to flash, an output module illuminates its LED) until a new device is selected or the permanent address is entered.

In this way it is possible to locate where the device is.

☞ The enroll process doesn't take place until all loop wiring trouble have been removed.

☞ The auto-addressing procedure have to be used when on the loop there are NG1 devices, otherwise it doesn't have effect.

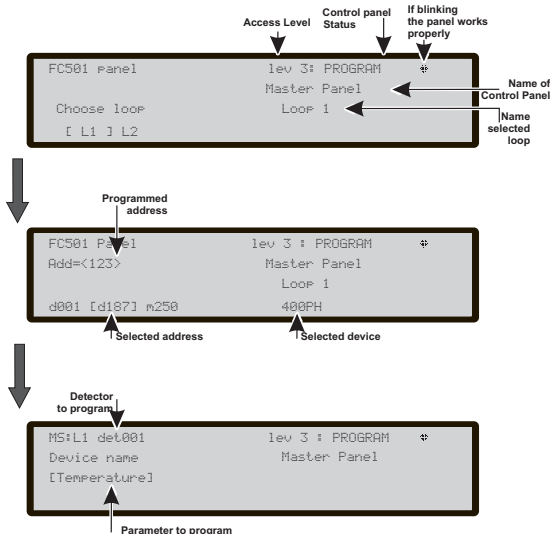

Figure 43 Pages of Selecting and programming Devices on Loop

☞ The device mapping process doesn't take place until all double address faults have been removed

2 KEY -Device

The **Device** option in the PROGRAMMING menu activates the screen used to select and program the devices on the loops (see figure 43);

■ **Choose the Loop** (see User Manual **View Devices**)
In this phase:

Alphanumeric keypad No function is related to the Alphanumeric keypad.

Cursor Keys No function is related to **UP** Key;
No function is related to **Down** Key;
The **Right** key selects the next available Loop;
The **Left** key selects the previous available Loop

Heat detector	Smoke detector	Smoke + Heat detector	Heat + CO detector	Heat+Smoke + CO detector
Remove device? No Yes	Remove device? No Yes	Remove device? No Yes	Remove device? No Yes	Remove device? No Yes
Working mode: DAY: <u>A2S</u> CR A1R		Working mode: DAY: <u>Temp= A2S</u> A1R DIS	Working mode: DAY: <u>CO=Default</u> Enhanced Disabled	Working mode: DAY: <u>Universal</u> High Immunity
Working mode: NIGHT: <u>A2S</u> CR A1R		Working mode: NIGHT: <u>Temp= A2S</u> A1R DIS Smoke= <u>Default</u> Enhanced Disable	Working mode: NIGHT: <u>CO=Default</u> Enhanced Disabled	Working mode: NIGHT: <u>Universal</u> High Immunity
		Working mode: DAY: Smoke= <u>Default</u> Enhanced Disable	Working mode: DAY: <u>Temp= A2S</u> A1R DIS	
		Working mode: NIGHT: Smoke= <u>Default</u> Enhanced Disable	Working mode: NIGHT: <u>Temp= A2S</u> A1R DIS	
Detector label	Detector label	Detector label	Detector label	Detector label
Assigned zone	Assigned zone	Assigned zone	Assigned zone	Assigned zone
Detector base <u>Standard</u> Isolator Relay Sounder Addressable	Detector base <u>Standard</u> Isolator Relay Sounder Addressable	Detector base <u>Standard</u> Isolator Relay Sounder Addressable	Detector base <u>Standard</u> Isolator Relay Sounder Addressable	
Callpoint	Generic Module	DDM Module		
Remove device? No Yes	Remove device? No Yes	Remove device? No Yes		
Callpoint label	Module label	Module label		
Assigned zone		Detector type <u>CNV conventional</u> <u>GSO 4-20 mA source</u> <u>GSI 4-20 mA sink</u>		
	Channel to program	Channel to program		
Generic digital input channel (loop devices)	Generic digital output channel (loop devices)	DDM input channel		
Working mode: <u>B NO</u> C NO C NC				
Input label	Output label	Input label		
Assigned Zone	Trigger Zone # 1	Assigned Zone		
	Trigger Zone # 2			
	Trigger Zone event <u>ALA Alarm</u> DLY Delay to alarm WAR warning FAU fault TST Test DK Double Knock Silenceable <u>On</u> Off			
	Trigger Zone # 3 Trigger Zone # 4 Trigger Point # 1 Trigger Point # 2 Trigger Point # 3			

Table 9 Values table of the programming devices
Note: The underlined options are the default options.

ESC key : ESC key deletes the procedure and returns to the previous page;

ENTER The ENTER key accepts the selection and activates the corresponding programming page. Regarding the figure 43, the “selected device” field shows the currently selected device. The “Add ” field is used to enter the address of the selected device. The scroll bar of available devices shows the addresses and the class of all devices configured in the selected loop. d087 address of the device (three digits); class of device: d = detector, m = module. The scroll can be viewed by using the cursor keys or entering a device address in the “Add ” field.

In case the address entered does not exist, the scroll bar moves to the next available address.

Choose the Device

In this phase:

Alphanumeric keypad Used to enter the address of the device that has to be selected; if the address doesn't exist the next device available will be selected.

If the device exists, square brackets will appear next to the address, but if the entered address does not exist or is different from the one selected in the bar below, arrows appear.

Cursor Keys No function is related to **UP** or **Down** Key. The **Right** key selects the next available Device. The **Left** key selects the previous available Device.

ESC Key The **Esc** key deletes the procedure and returns to the previous page.

ENTER Key The **ENTER** key accepts the selection and activates the corresponding programming page.

Loop devices programming page

After selecting the Loop and the device, (see the third part of Figure 43) it is possible to program various parameters relevant to the type of device, see Table 9.

3 KEY - SW zone

The **SW zone** option in the PROGRAMMING menu activates the screen used to select and program the Software zone (see figure 44).

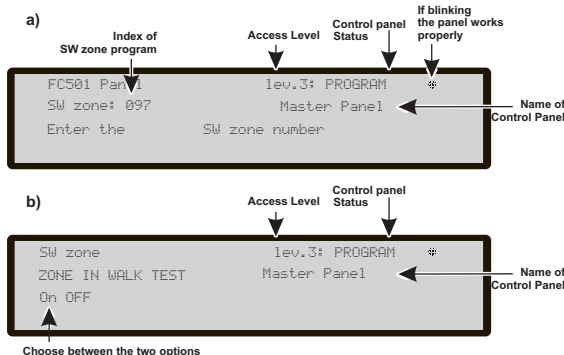

Figure 44 Pages of Selecting and programming of SW zones

The Alphanumeric keypad The Alphanumeric keypad is used to select the zones number (ID).

Cursor Keys No function is related to **UP** and **Down** Keys.

The **Right** key to selects the next available SW zone. The **Left** key to selects the previous available SW zone.

ESC key The **ESC** key deletes the procedure and returns to the previous page;

ENTER Key Accept the SW zone selection and activate the loop device programming page, if the SW zone exists, otherwise a warning page is displayed for 5s "WRONG VALUE! enter the parameter again". After 5s the User Interface moves back to the choose SW zone pages.

SW zone in WALK TEST

After selecting the SW Zone, you will be able to enable or disable the option Zone in WALK TEST (OFF) or not (off);

- if the option all (ALL) is selected , all the devices assigned to zones in WALK TEST mode, will NOT generate alarm in the case of their activation but they will reach the TEST status.
- If the option det (DET) is selected , only the detectors assigned to zones in WALK TEST mode, will NOT generate alarm in the case of their activation but will reach the TEST status.
- If the option cp (CP) is selected , only the call-points assigned to zones in WALK TEST mode, will NOT generate alarm in the case of their activation but will reach the TEST status.

The presence of a zone in WALK TEST mode is signalled by the TEST yellow LED on the User

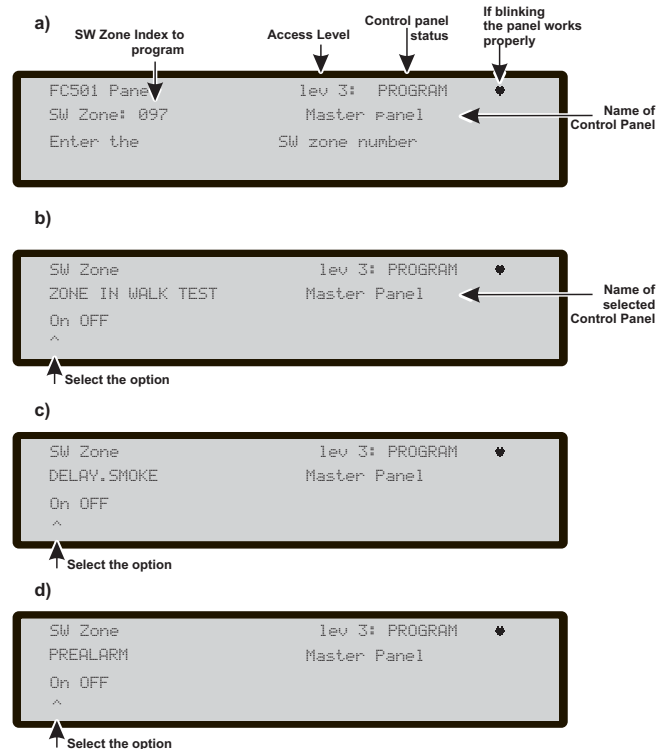

Figure 45 Page of programming option delay Detector alarm verification

Interface. More than one zone can be put in WALK TEST mode at the same time.

Cursor Key No function is related to **UP** and **Down** Keys. **Right** key: selects the following ON -OFF-ALL-det-cp. **Left** key: selects the previous ON-OFF-ALL-det-cp.

ESC Key **ESC** key deletes the procedure and returns to the programming page.

ENTER key The **ENTER** key accepts the selection and activates the corresponding programming page

Detector alarm verification (Smoke delay)

For each zone, it is possible to program the delayed activation of smoke detectors, according to the following schedule:

when the smoke level exceeds the alarm threshold, the panel does not signal anything at first;

- after 60 seconds if the smoke level is still above the threshold, the system goes into alarm condition, otherwise there are no signals;

- within 30 minutes, a new alarm or activation of another sensor in the same zone causes the alarm of fire panel.

To program the delay on the activation of smoke detectors, from Programming menu: **SW Zone (KEY 3)**.

- After selecting the SW Zone, on the subsequent display about the zone to test, select OFF and press Enter.

- on the subsequent display about the new option "Detector alarm verification", select ON (to enable) and press Enter. In this phase:

Cursor Keys No function is related to **Up** and **Down** keys.

Use the **Right** and **Left** keys to select: On-OFF.

ESC key Use the **ESC** key to delete the operation and to step back to previous page.

ENTER key Use the **ENTER** key to accept the selection and activate the programming page.

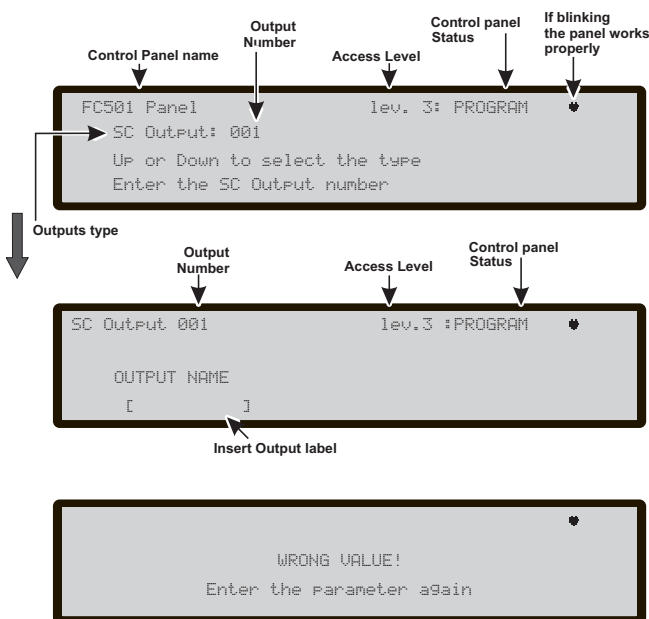

Figure 46 Pages for programming "SC active on disablements" option.

Prealarm

For each zone, it is possible to program the activation of a common pre-alarm delay (10 min.). The procedure is the same of the previous parameters and also the functionality of the Cursors, Esc and Enter key is the same (see Fig.45d).

4 KEY- OUTPUT

The Outputs option, **KEY 4** in the **PROGRAMMING** menu, activates the output programming screen. It is used to select the type of **Output**; followed by the programming procedure for that output.

Choose Output

In this phase:

Alphanumeric keypad The Alphanumeric keypad is used to enter the number of **SC** output.

Cursor Keys The **UP** Key: shows the next output category (**SC-OC**).

The **Down** Key shows the previous output category.

Right and **Left** keys: no functions is related to these keys.

ESC Key Use **ESC** key to cancel the operation and to step back to previous page.

ENTER Key Use the **ENTER** key to accept the selection and activate the output selection and activate the loop device programming page if the output exists, otherwise a warning page is displayed for 5s.

"WRONG VALUE! enter the parameter again"

After 5s the User Interface moves back to the page for selecting the outputs.

Once the Output has been programmed (type and identification number) and the **ENTER** key is pressed to accept the selection, enter the label for that output.

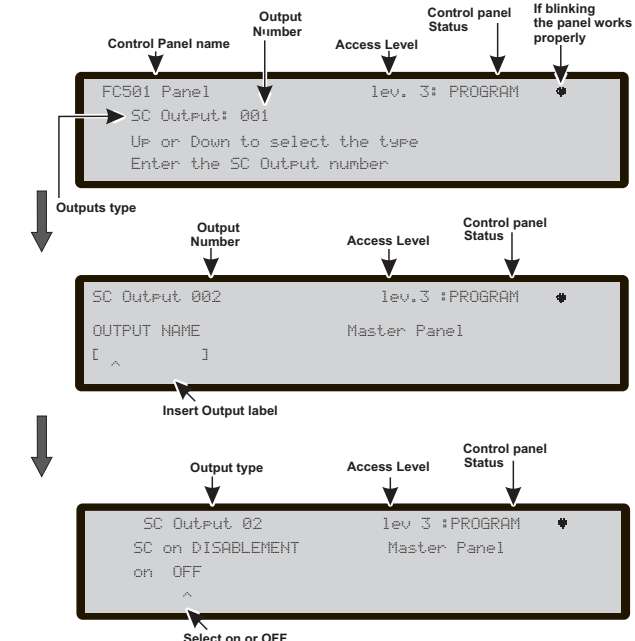

Figure 47 Pages of Selecting and programming SC active on disablement

■ SC on disablements

In reference only to SC2 programmable output, the SC Outputs can be programmed to activate on disablement of any part of the system.

From PROGRAMMING Menu select **Output** (KEY 4) and then work through the steps shown in Figure 47:

- select the SC2 to program the option "SC on disablements";
- in the subsequent display display insert the name of Output and then press ENTER;
- in the following display, press ON to enable the new option and then press ENTER. In this phase:

Cursor Keys No function is related to **Up** key;
 No function is related to **Down** key;
 Use the **Right key** to select: On-OFF;
 Use the **Left key** to select: On-OFF.

ESC key Use **ESC** key to cancel the operation and to step back to previous page.

ENTER key Use the **ENTER** key to accept the selection and activate the programming page.

 If the SC2 has this option programmed, it will be not silenceable.

The parameters that may be programmed via panel's User Interface for the loop devices are:

- Output label
- Trigger zone #1
- Trigger zone #2

Events trigger alarm zone, as shown below:

- ALA** alarm
- DLY** Delay to Alarm
- WAR** warning
- FAU** fault
- TST** test
- DK** Double knock.

-Silenceable Output or Not.

Programming procedures and functions of the keys are the same as for the SC on disablements.

5 Key- Network

The Network option of Programming menu activates the procedure to configure the modules FC500MFI.

When all the Control panels and the FC500MFI modules are connected in the Network,

- 1- use the **5** Key to select **Network**, from Programming

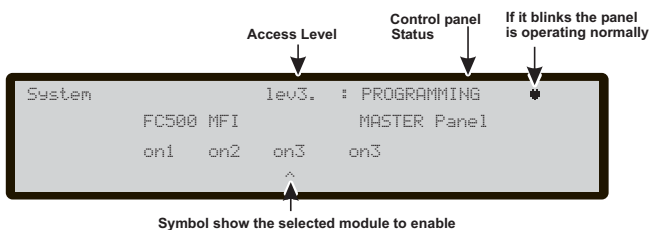



Figure 48 Display to enable the FC500MFI module

- page (Figure 39) in the User interface;
- 2- the Display of Figure 48 will be shown;
- 3- moving with the arrow keys to select the FC500MFI module to be configured ← or → (the symbol ^ under the name show the selected module), enable a FC500MFI module by the arrow ↑ or disable it by the arrow ↓:
 the module name will appear in uppercase if enabled. Press the Enter key to confirm.

In the ANALYZE status (L1 level): to display the related output status is used an acronym. The acronym are:

- " **OK!**", The net. device is sensed as connected and working;
- " **ko!**", The net. device is sensed as not connected
- " **FAU**", The net. device is faulty
- " **DIS**", The net. device is disabled
- " **--** ", The net. device is not configured in the network
- " **OLD**", The net. device has an obsolete FW version.

 For an explanation of the features and programming (addresses), see the dedicated manual of the FC500MFI module.

In this phase:

Alphanumeric keypad No function is related to the Alphanumeric keypad.

Cursor Keys The **Up** key enables the selected module (e.g. ON1-uppercase).
 The **Down** key disables the selected module (e.g. on1-lowercase).
 Use the **Right** key to select the module.
 Use the **Left** key to select the module.

ESC Key Use **ESC** key to abort the programming procedure.

ENTER key Use the **ENTER** key to confirm the programming procedure and to leave the page.

6 KEY - MAP DEVICE

This option activates the "On Demand device mapping" feature to modify the devices addressing scheme in a working system. In a system where the addressing scheme is well known because all devices are singularly addressed via Service Tool or via the "device mapping" feature embedded in the loop enroll process (1 KEY). This means that this new feature is not intended to acquire new devices on the loops (for this purpose

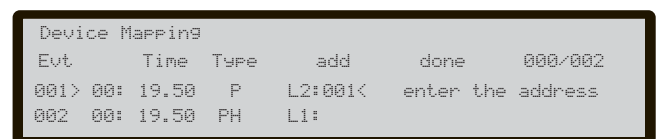

Figure 49 Display "on demand device mapping"

the Enroll feature have to be used). Differently from the "device mapping" feature embedded in the loop enroll process, the "On Demand" version will not automatically modify: devices labels and assigned zone.

All the devices, comprised also the "unique" types will put in the "activated list". The "only output" type devices are treated as in the standard device mapping procedure (they will be singularly activated when selected in the list).

In this phase:

Alphanumeric keypad The Alphanumeric keypad is used to enter the new address value: 0-9;

Cursor Keys the UP key, Short press: to scroll to the previous event in the list, Long press: to start the automatic scroll of the previous event in the list. the Down key, Short press: to scroll to the next event in the list, Long press: to start the automatic scroll of the next event in the list.

The RIGHT key: to program the selected device; The LEFT to continue the mapping procedure.

ESC key The ESC key: to end the mapping procedure and exit.

ENTER key the ENTER key: to confirm the entered address value.

To stop the automatic scroll, short press of the UP or Down key.

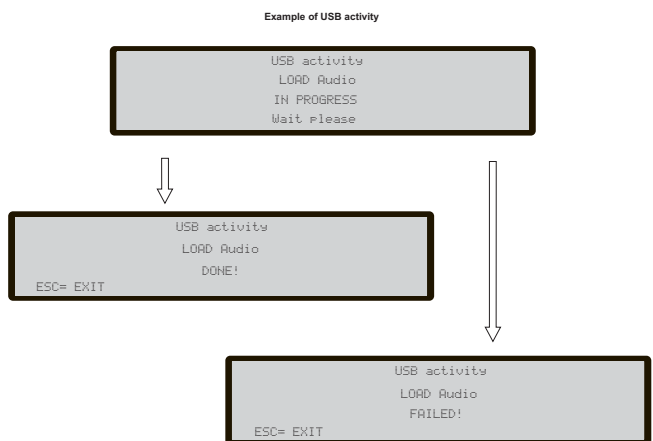

Figure 51 Example USB activities

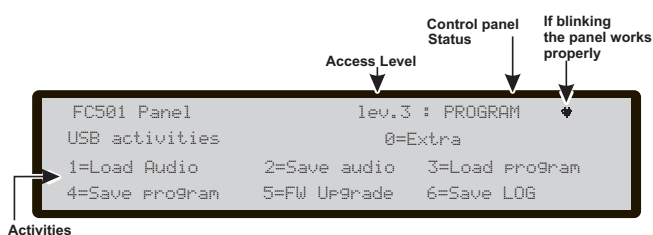

Figure 50 Page of USB activities

7 KEY -USB

The option **USB** in the **PROGRAMMING** menu activates the **USB** programming page. **7** Key is used to select USB programming page, Figure 50 shows:

- 1) Load Audio
- 2) Save Audio
- 3) Load programming
- 4) Save programming
- 5) FW Upgrade
- 6) Save LOG.

In this phase:

Alphanumeric keypad Allows the selection of USB activities.

- 1) To load, from USB pendrive to panel, the AUDIO file containing the voice messages.
- 2) To save, from the panel to USB pendrive, the current AUDIO messages.
- 3) To load, from USB pendrive to panel, the programming data (*).
- 4) To save, from panel to USB pendrive, the current panel programming data.
- 5) To upgrade the panel Firmware from USB pendrive (**)(***).
- 6) To save, from panel to USB pendrive, the current LOG data in the panel.

Cursor Keys No function is related to **UP**, **Down**, **Right** and **Left** Keys.

ESC Key The **ESC** key is used to exit from the USB activity result page.

ENTER Key No function is related to the **ENTER** Key.

() The loaded data will overwrite the current data in the panel.*

*(**) The file containing the expected FW version to upgrade the panel has to be present in the F_fw directory in the pendrive.*

*(***) To do the firmware upgrade of the FC500 Repeater and the MFI module is not possible using the USB pendrive.*

8 KEY -SYSTEM

The option **SYSTEM** in the programming menu activates: - the system language selection page (Display language) see Figure 52.

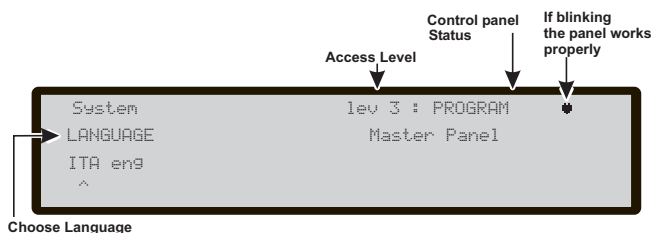

Figure 52 Page to select the language of the system

 Other languages can be loaded from software

After selecting the language, it is possible to program:
-PANEL ID
-PANEL TYPE (FC501-L/FC501-H)
-BATTERY TYPE (7Ah/12Ah/38Ah)
-DAY/NIGHT MODE or AUTO
-PREALARM TIME.
-COPY ON ZONE?

Alphanumeric keypad No function is related to the Alphanumeric keypad.

Cursor Keys No function is related to **UP** and **Down** Keys.

Use the **Right** key to select the next option.
Use the **Left** key to select the previous option.

ESC Key Use **ESC** key to cancel the operation and to step back to MAIN page.

ENTER Key **ENTER** Key accepts the selection.
In sequence:

■ Panel ID

Enter up to 4 digits to identify the configuration file system, so it is possible to distinguish it from other configuration files (for example on a USB stick, it is possible to load multiple systems without any configuration files overlap). In sequence:

-PANEL TYPE (FC501-L/FC501-H)
-BATTERY TYPE (7Ah/12Ah/38Ah)

■ Day / Night / Auto

The display for programming Day/Night/Auto mode will be shown. If Automatic mode is chosen, it is necessary to set the transition time from one mode to another.

 See the LED Day/Night mode LED change status.

In sequence:

■ Pre-alarm time

Enter the Prealarm time in minutes (max 9).
The amount of Prealarm Time+Investigation Time should not exceed 10 min.

■ Copy on Zone?

Moving on the **YES** option using the Cursor keys it is possible to copy the same Prealarm time in all the zones.



```
WARNING!  
All programming data will be lost.  
Do you want to continue?  
ESC=NO                               ENTER=YES
```

Figure 53 Restore default page

9 KEY- Restore Default

The Restore Default option from the PROGRAMMING menu will allow you to restore default setting.

Use the **9 Key** to select **Restore Default**, the display will show the Figure 53: in this phase:

Alphanumeric keypad No function is related to Alphanumeric keypad.

Cursor Keys No function is related to **UP**, **Down**, **Right** and **Left** Keys.

ESC Key The **ESC** Key cancels the procedure and returns to the previous page;

ENTER key The **ENTER** Key starts the default settings restore procedure.

 If the motherboard of the Panel is connected with a FC500IP module, the procedure to Restore factory Default (key 9) will have no effect on the FC500IP module. To restore the FC500IP module to factory default use the procedure of the FireClass Console software.

FC500REP Repeater Address from the Repeater panel ONLY

After the FC501 control panel has been connected, at the first start-up the FC500REP will verify the presence of the address and its conformity. If the address is correct, the Repeater will start to work; if the address is not correct the display will ask to insert a new address. The display on Figure 54 will be shown; in this phase:

Alphanumeric keypad Use the alphanumeric keypad to insert the address of 1 digit.

Cursor Keys No function is related to **UP**, **Down**, **Right** and **Left** Keys;

ESC Key Use **ESC** key to cancel the operation and to step back to previous page.

ENTER Key Use the **ENTER** Key to confirm the address.

 If for any reason the address of a repeater is changed by mistake, the system will show the message in the Figure 54, in this case the address of the repeater can be changed using the **ESC** key.



```
!!FAULT!!  
Serial link is down  
unable to communicate with the system  
press ESC to change repeater address
```

Figure 54 Display "the repeater link is down"

QUICK START-UP PROCEDURE

This procedure allows the quick start-up of the FC501 fire detection system.

When the loops are wired, electrically verified and all the devices have been installed in to the loop, it is possible to connect the loops terminals to the panel.

 *Before powering-on the Fire control panel, ensure that the Earth Line has been connected.*

PROCEDURE

1. At first panel power-on will start a FW procedure to verify/program if some vital information for the User Interface and for the panel, are programmed and are consistent. These information are:

- Selected language
- Panel Identification number
- The panel Type (FC501-L/FC501-H)
- Installed batteries capacity (7Ah/12Ah/38Ah)

2. After have verified/programmed the previous data, insert the date and time, see MODIFY Procedure (User Manual). This step is important to guarantee the Log file consistency.

At this point the panel will start the first system initialization verifying the loops integrity, warming up the smoke sensor circuitry, and the autoaddressing phase of the devices, with the consequent search for no addressable devices, and devices with the same address (see procedure 1 Key Autoenrolling and Note on Autoaddressing).

 *NOTE: The panel in this phase is configured to manage closed loops (4 wires loop), if it is connected to a spur (2 wires loop) it will generate broken loop faults.*

At the end of this first initialization phase the User Interface will be displayed at the main page with the capability to accept to the command and control functions.

3. Select the function Program pressing the key 1.
4. Insert the installer password (default=00000) every digit will be masked by * symbol.
5. Choose the option by pressing the key 1.

The panel will start the enrolling procedure.

This procedure is divided into three main phases:

- 1 Auto-learning
- 2 Auto- addressing
- 3 Device Mapping

It is possible to stop the "AUTO" option at the end of each phase; the results are different.

1 AUTO-LEARNING

In the first phase the panel looks for all the devices on the loop already addressed (with the service tool).

During this phase, the panel will ask what pattern of automatic assignment of zones shall be applied to found devices (see Figure 55, 1B).

In the case of panel already configured, it indicates any differences and asks how to proceed (see Figure 55, 1A), in which case the scheme of Automatic assignment of the zones will be applied only to new devices found.

If you stop the AUTO option at the end of this first phase, see Figure 56 (A) will happen :

- The control panel will take over all devices with an address between 1 and 128.
- The programming device at their default configuration.
- Automatic assignment of labels.
- Automatic assignment of the zones according to the scheme chosen during that phase.
- The output channels of the modules, sounders and beacons will be enabled to active on fire alarm of the assigned area (except in the case the zone auto-assignment phase will not be chosen, accordingly all the output channels of the modules, sounders and the beacons will be activated for panel alarm.
- The faults "NOT PROGRAMMING DEVICE" and "wrong addresses" will be generated in the case of not addressed devices or with address greater than 128, respectively.

 *If the enrolling result differs from the previously stored loop configuration a warning message will be displayed and it is possible to reject the present enrolling result, maintaining the previous configuration, or accept them.*

 *The enrolling function will not be activated if there are loop related faults present.*

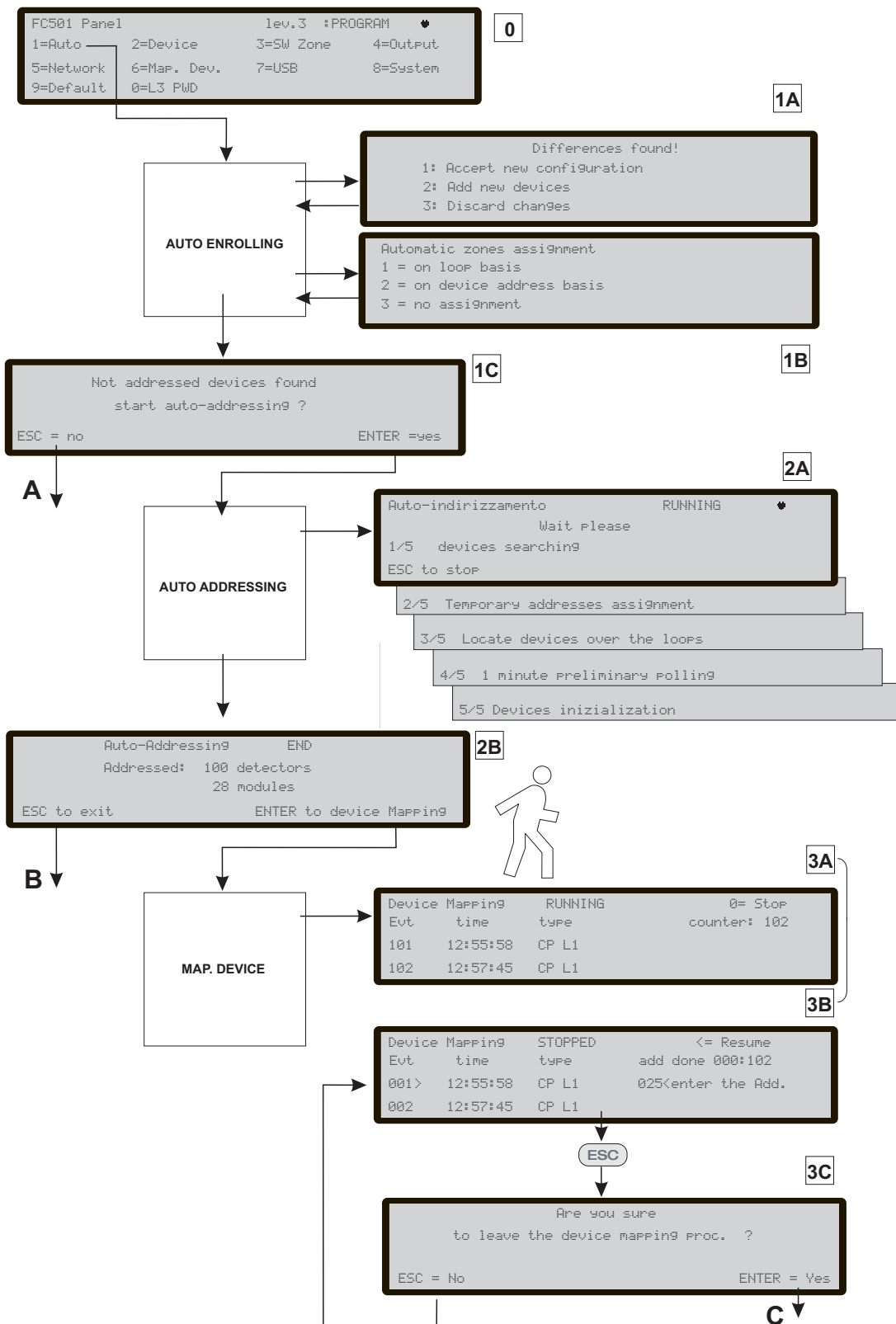

Figure 55 Programming option "AUTO"

2 AUTO-ADDRESSING

The second phase will be started, if during Auto-learning phase, not addressed devices have been identified or have an address greater than 128. During this phase all the not addressed devices will be detected. The panel assigns them a temporary address and configure them at default (see Figure 55, 2A).

If you stop the AUTO option at the end of this second phase, see Figure 55 (B) will happen:

- The auto assignment of the address to the not addressed devices
- The control panel will take over all devices
- The programming devices to their default configuration.
- Automatic assignment of labels.
- Automatic assignment of zones based on a loop of belonging.

LOOP	PANEL	MESSAGE			
		Differences found!	Automatic zones assignment	Not addressed devices found start autoaddressing ?	
1	All devices not addressed	DEFAULT			*
2	Some devices addressed + Some devices not addressed	DEFAULT		(Applicable only to the already addressed devices) *	*
3	All devices addressed	DEFAULT		*	
4	Fully addressed Same configuration	CONFIGURED			
5	Fully addressed Different configuration	CONFIGURED	*	New configuration	(Applicable only to all already addressed devices) *
			*	Add devices	(Applicable only to new already addressed devices) *
6	Same configuration + Not addressed devices	CONFIGURED			*
7	Different configuration (*) + Not addressed devices	CONFIGURED	*	New configuration	(Applicable only to all already addressed devices) *
			*	Add devices	(Applicable only to the new already addressed devices) *

Figure 56 The table shows the kind of messages, and relevant action required during the enroll process in function of the loop and panel configuration. Note (*) indicates that the message is displayed and relevant action is executed

- The output channels of the modules, sounders and beacons will be set to active on the alarm of the assigned zone.

3-DEVICE MAPPING

The third and last phase is activated on demand at the end of the Auto-addressing phase.

This phase allows:

- Locate the positioning in the system of all the devices through their activation (in the case of output modules only, sounders or beacons, they will be suitably activated by the panel (see Figure 55, 3A).
- Carry out a preliminary test of the system.
- Program the most important parameters of each located device.
- Automatically assign labels to all devices.
- Assign automatically the zones based on assigned address to each device.

- Automatically configure the output channels of the modules, sounders and beacons to activate on the alarm of the assigned zone.

The third phase represents a powerful and flexible tool that allows to "draw" the plant being in front of the panel and without the use of a PC and its SW configuration.

A series of controls have been designed to prevent the generation of incorrect or not manageable conditions.

For each device to locate occurs that:

- The address to be assigned does not belong to an older generation device (FC400 series).
- The address to be assigned is in the range from 1 to 128.
- The address to be assigned belongs to a new generation device and that device is present in the list of devices to locate.
- The address to be assigned is not among those assigned automatically.

In each case at the end of the device Mapping phase (see Figure 55, C) a check is performed to detect the presence of "doubles addresses"; in this case the involved addresses will be indicated and it will not be possible to abandon the procedure until the complete removal of the error condition.

The procedure for the devices mapping can also be launched outside the AUTO function, by activating the programming function called "localization. (Key 6, on the PROGRAM status) that allows to activate the procedure for devices mapping on demand, on a system already configured and without the need to proceed to their activation. It is meant to correct errors or change the system "on the run" and use all the features and capabilities described above.

System default

■ Zone assignment

To mimic a conventional panel the acquired device over the loops will be automatically assigned to a predefined zone. Two different scenarios are possible:

Exit at the end of the Auto Addressing phase without executing the Device Mapping process, in this case:

- all the devices located on loop #1 will be assigned to zone #1
- all the devices located on loop #2 will be assigned to zone #2
- all the devices located on loop #3 will be assigned to zone #3.

At the end of the Device Mapping process.

The device address to zone assignment scheme is the follow:

- From address 01 to address 16 assigned to zone #1
- From address 17 to address 32 assigned to zone #2
- From address 33 to address 48 assigned to zone #3
- From address 49 to address 64 assigned to zone #4
- From address 65 to address 80 assigned to zone #5
- From address 81 to address 96 assigned to zone #6
- From address 97 to address 112 assigned to zone #7
- From address 113 to address 128 assigned to zone #8

If an address is not manually assigned to a device (either via FC490ST or during the device mapping phase) no zone will be assigned to it.

The previous zone assignment schemes are applied also to the first "trigger zone" in the case of output only devices (sounder, beacon, SNM module,...) or output channel of Input/output devices.

Note that in the case of none zone assigned, the output channel trigger event is the panel alarm.

■ System default parameters

Temperature detector	default values
Label	See note (**)
Enablement	Enabled
Led blink	On
Assigned zone	(see: "Zone assignment)
Base type	Normal
Use zone setting	Yes
Day operating mode	A2S
Night operating mode	A2S

Smoke detector	default values
Label	See note (**)
Enablement	Enabled
Led blink	On
Assigned zone	(see: "Zone assignment)
Base type	Normal
Use zone setting	Yes
Day smoke sensitivity	Medium
Night smoke sensitivity	Medium

Smoke+Temperature detector	default values
Label	See note (**)
Enablement	Enabled
Led blink	On
Assigned zone	(see: "Zone assignment)
Base type	Normal
Use zone setting	Yes
Day temp. operating mode	A2S
Day smoke operating mode	normal
Day smoke sensitivity	Medium
Night temp. operating mode	A2S
Night smoke operating mode	normal
Night smoke sensitivity	Medium

CO + Temperature detector	default values
Label	See note (**)
Enablement	Enabled
Led blink	On
Assigned zone	(see: "Zone assignment)
Base type	Normal
Use zone setting	Yes
Day temp. operating mode	A2S
Day CO operating mode	normal
Day CO sensitivity	medium
Night temp. operating mode	A2S
Night CO mode	normal
Night CO sensitivity	medium

CO+Smoke+Temperature detector default values

Label	See note (**)
Enablement	Enabled
Led blink	On
Assigned zone	(see: "Zone assignment")
Base type	Normal
Use zone setting	Yes
Day algorithm	Universal
Night temp. operating mode	Universal

Modules default values

Label	See note (**)
Enablement	Yes
Led blink	On
Activation unit (where applicable)	Off
Act as SC1 (where applicable)	Off

Input Channels

Enablement	Yes
Channel Label	See note (**)
Assigned zone	Address related
(see: "Zone assignment")	
Operating mode	Style C, NO
Use zone setting	Yes

Output Channels

Enablement	Yes
Channel label	See note (**)
Trigger zone #1	Address related
(see: "Zone assignment")	
Trigger zone #2	None
Trigger zone #3 (where applicable)	None
Trigger zone #4 (where applicable)	None
Trigger point #1	None
Trigger point #2	None
Trigger point #3	None
Silenceable	Yes
Active on disablement (where applicable)	Off
Trigger on event	Zone Alarm
Delay from alarm	Off
Silenceable	Yes
Sounder pattern (where applicable)	7Hz fast sweep
Sounder volume (where applicable)	high
Beacon enablement (where applicable)	Yes
Beacon flash rate (where applicable)	0.5 Hz

DDM module default values

Label	See note (**)
Enablement	Enabled
Led blink	On
External power	On
Detector type	4/20 mA Source
Threshold set	Set #1

Input Channels

Enablement	Enabled
Channel Label	See note (**)
Assigned zone	Address related
(see: "Zone assignment")	
Use zone setting	Yes

TSM module default values

Label	See note (**)
Enablement	Enabled
Led blink	On
External power	On
Input function	Door monitoring
Loop monitoring	Off
Door monitoring event	Fault
Monitoring time	30s

Input Channel

Enablement	Enabled
Channel Label	See note (**)
Assigned zone	Address related
(see: "Zone assignment")	
Operating mode	Style C, NO

Output channel

Enablement	Yes
Channel label	See note (**)
Trigger zone #1	Address related
(see: "Zone assignment")	
Trigger zone #2	None
Trigger point #1	None
Trigger point #2	None
Trigger point #3	None
Silenceable	Yes
Trigger on event	Zone Alarm
Delay from alarm	Off

Zones default values

Label	Zone AAA(*)
Enablement	Enabled
Walk test	Off
Detector warning	Off
Delay to alarm	Off
Drift compensation	Off
Double knock	Off
Smoke verification	Off
Delay to alarm duration	0s

On board programmable outputs default values

Enablement	Yes
Channel label	tttt y(****)
Trigger zone #1	none
Trigger zone #2	None
Trigger zone #3	None
Trigger zone #4	None

Trigger point #1	None	SC outpts -> tttt="SC "
Trigger point #2	None	Programmabel outputs -> tttt="OC "
Trigger point #3	None	y = output number
Silenceable	Yes	(****) xx represent the telephone number ID (2 digits),
Active on disablement (where applicable)	Off	
Trigger on event	none	
Delay from alarm	Off	

General options	default values
Investigation delay	300s
Main fault delay	1m
Delay to alarm	60s
Silence duration	60s
Reset	2s
Loop 1 wires	4 wires
Loop 2 wires	4 wires
Loop 3 wires	4 wires
Day/Night mode	Day mode
SC1 disablement	Enabled
PSTN communicator enablement	Not operative
IP communicator enablement	Not present
NETWORK enablement	Disabled
Delay from alarm #1	0s
Delay from alarm #2	0s
Delay from alarm #3	0s
Delay from alarm #4	0s
Delay from alarm #5	0s

PSTN communicator	default values
Tone check	On
Start playing after	Selection
Call attempts	3
Iteration	3
Call all telemonitoring numbers	No
Call all voice message numbers	No
Telephone number label	TEL. NUMBER xx(****)
All Telephone numbers behavior	None
Trigger events	Panel alarm, Panel Fault
Message #1 to #7	Pre recorded

Notes:

(**) Automatically assigned Module label.
The label is composed by a brief description of the device followed by its address.

Automatically assigned Module channel label
The label is composed by a first part containing the module acronym and address followed by the brief description of the channel using the acronym printed on the module PCB.

xxx = module acronym
yyy= module address

For example "DDM098: Ingresso A" is the default label for the input #1 of the FC410DDM module at address 98.

(****) tttt represent the on board output type (4 chars),

The following is a list of accessories for FC501 control panel, with a description of the main features. For further information about these accessories, please refer to the instructions supplied with the accessories themselves or download them from the website: [web: http://www.fireclass.net](http://www.fireclass.net).

FC500IP - IP Module

The FC500IP is an IP Module which is used to connect the FC501 fire panel to a LAN.

The IP Module may be connected to a LAN using a private IP address or a DHCP address.

The same procedures may be performed using the FireClass console application, either through the serial port or the network. With a public IP address, it is also possible to manage and monitor the control panel from anywhere in the world, as long as you have access to the Internet.

4B - Universal Base

The 4B Universal base is for use with the FC460/FC400/600 series of detectors.

The base may be fixed directly to:

- British (fixing centres 50mm) or European (fixing centres 70mm) conduit box;
- 4B EM Euro Mounting Box;
- the suspended ceiling, through the CTA adapter;
- directly to the ceiling.

FC460H or FC400H-Addressable Heat Detector

The detector is intended to plug into the following:

- 4B 4" Universal Base
- 4B-I 4" Isolator Base
- FC430SB Low Power Sounder Base
- FC430LPSB Loop Powered Addressable Sounder Base.
- FC430LPASB Loop Powered Addressable Sounder/Beacon Base.

Software within the controller is used to interpret the returned heat values to raise an alarm or other appropriate response according to the type of detector configured in Fire Class Console.

The mode of detector may be:

- EN54-5 A1R, rate-of-rise normal ambient
- EN54-5 A2S, fixed 60 °C
- EN54-5 CR, rate-of-rise high ambient..

FC460P or FC400P - Addressable Optical Smoke

The FC460P/FC400P optical smoke detector forms part of the FC460/FC400 Series Addressable Fire detectors.

- 4BI 4" Isolator Base
- 4B 4" Universal Base
- FC430SB Low Power Sounder Base
- FC430LPSB Loop Powered Addressable Sounder Base.
- FC430LPASB Loop Powered Addressable Sounder/Beacon Base.

Software within the controller is used to interpret the returned optical and heat values to raise alarm or other appropriate response according to the type of detector configured in Fire Class Console.

FC460PH or FC400PH - Addressable Optical Smoke & Heat Detector

The detector is intended to plug into one of the following:

- 4B 4" Universal Base
- 4B-I 4" Isolator Base
- FC430SB Low Power Sounder Base
- FC430LPSB Loop Powered Addressable Sounder Base.
- FC430LPASB Loop Powered Addressable Sounder/Beacon Base.

Software within the controller is used to interpret the returned optical and heat values to raise alarm or other appropriate response according to the type of detector configured in Fire Class Console. The mode of detector may be:

- Mode 1 - Optical smoke only detector (sensitivity High, Normal or Low)
- Mode 2 - Optical (sensitivity High, Normal or Low) and heat fixed temperature 60 °C (A2S)
- Mode 3 - Heat only rate-of-rise (A1R) detector (no sensitivity selection)
- Mode 4 - Heat fixed temperature 60 °C (A2S) (no sensitivity selection)
- Mode 5 - Heat rate-of-rise (A1R) detector and optical smoke (sensitivity High, Normal or Low)
- Mode 6 - HPO (Advanced) smoke detector (sensitivity High, Normal or Low)
- Mode 7 - HPO (Advanced) and heat fixed temperature 60 °C (A2S)
- Mode 8 - HPO (Advanced) and heat rate-of-rise (A1R).

FC460PC Addressable Optical Smoke & Heat Detector & CO

Detector of high performance, of smoke, temperature and CO. The use of the three elements of the sensor, in synergy, allows to determine with accuracy the presence of all types of fires and at the same time having an exceptional immunity to false alarms.

The functionalities of the FC460PC detector are: self-monitoring, self-testing, status indicator, remote LED and threshold compensation. The detector FC460PC is compatible with the existing bases.

FC410LI - Line Isolator Module

The FC410LI Line Isolator Module is designed to be used on the FC addressable controller loop circuits. It monitors the line condition and when detecting a short circuit will isolate the affected section whilst allowing the rest of the addressing circuit to function normally.

The purpose of the FC410LI Line Isolator Module is to ensure that, on a looped addressable system, no short circuit fault can disable more detection devices than would be lost on a conventional non-addressable fire circuit.

FC410MIM - Mini Input Module

The FC410MIM Mini Input module is designed to monitor fire contacts, such as extinguishing system control, ventilation control, fire door control etc. The module provides one identifiable detection spur which is capable of monitoring multiple normally open contacts or a single normally closed contact. The FC410MIM may be mounted in any electrical enclosure with sufficient depth to accommodate FC410MIM and the contacts monitored by the IN+ and IN- terminals, ie, no field wiring. The remote LED (if required, not supplied) must be located within the same electrical enclosure.

FC410MIO - Small Addressable Multi I/O Module

The FC410MIO Multi I/O Module has three class B inputs and two outputs from latching relays. The class B inputs can monitor fire contacts such as extinguishing system control, ventilation control, fire door control etc. The two relays outputs are dry form C that provide volt-free relay changeover contacts. A maximum of two HVR800 High Voltage Relay Modules can be individually driven and controlled by an FC410MIO if all HVR800s are powered by 24V dc or 24V ac. In this application, the HVR800s are controlled by the two latching relays on the FC410MIO. A maximum of four HVR800 High Voltage Relay Modules can be individually driven and controlled by an FC410MIO if all HVR800s are powered by 120V ac or 240V ac. In this application, the HVR800s are controlled by the four control outputs (O1+/O1- to O4+/O4-) on the FC410MIO.

FC410SIO - Single Input/Output Module

The FC410SIO Single Input/Output Module is designed to provide a monitored open collector input and a volt free relay changeover output.

FC410SIO can switch up to 2 A @ 24 Vdc.

FC420CP - Addressable Break Glass Callpoint (indoor)

FC420CP Addressable Break Glass Callpoint is designed to monitor and signal the condition of a switch contact that is operated by activating the break glass element. The type of alarm generated by the callpoint is configured in FireClass Console. The FC420CP call point meets the requirements of EN54 Pt.11. The FC420CP is fitted to a standard surface mount plastic backbox, standard single gang metal plaster box (35 mm for flush mounting) or standard single gang metal plaster box (25 mm) with backbox.

FC421CP - Addressable Break Glass Callpoint (outdoor)

FC421CP Weatherproof Addressable Break Glass Callpoint is designed to monitor and signal the condition of a switch contact that is operated by activating the break glass element. The type of alarm generated by the callpoint is configured in FireClass Console. The FC421CP callpoint meets the requirements of EN54 Pt.11. The FC421CP is fitted into a standard weatherproof break glass callpoint housing.

FC430SAB/SAM - Sounder Base Address Modules

The Sounder Base Address Modules (FC430SAM/FC430SAB) are designed to control a loop powered sounder base for use with the FC system, one variant (FC430SAB) has an integral beacon. They may also be used to drive a relay base. The units are used to supply the address decoding in place of a detector, thus providing a loop powered sounder when used in conjunction with an FC430SB. The modules are colour matched to the sounder bases. The FC430SAM/FC430SAB is locked into the base using the locking device integral to the sounder base.

FC430SB - Loop Low Power Sounder Base

The FC430SB Loop Low Power Sounder Base provides an additional sounder function on the FC addressable loop circuit. The FC430SB Loop Low Sounder Base requires an associated detector in order to operate, as it uses the address of the detector that is fitted to it. Removal of the detector or loss of power to the loop will cause the sounder to cease operating. A maximum of 45 Sounder Bases at full volume may be connected to the loop.

FC450IB - Isolator Base

The FC400 Series Detectors, as supplied, use a common FC450IB Isolator Base assembly.

The base may be fixed directly to:

- British (fixing centres 50mm) or European (fixing centres 70mm) conduit box;
- FC450EMB Euro Mounting Box;
- Directly to the ceiling.

FC490ST - Loop Service Tool

The FC490ST Loop Service Tool is used to program the loop address into FC addressable devices. The FC490ST displays information and performs tests on devices. It has a 32 character backlit LCD alphanumeric display, arranged in 2 rows of 16 characters and four 'softkeys', F1, F2, F3 and F4. Power for the FC490ST is derived from 4 AA size nickel metal hydride rechargeable batteries. It may be run from an unregulated +12V dc input ie, car cigarette lighter connection or 110/230V ac mains adaptor, both of which will recharge the batteries as well.

FC410BDM - Beam Detector Module

The FC410BDM Beam Detector Interface Module is designed to interface FIRERAY 50 Beam Detectors to the FC Digital Addressable Loop (it must not be used with other types of beam detector). The FC410BDM monitors the Fire and Fault contacts and also monitors for open and short circuits on the connections between the interface and the beam detector. For remote siting of the FIRERAY 50 an optional BTM800 Terminal Module can be used with 4 core cable.

The FIRERAY 50 transmitter and receiver units are mounted in the same housing.

The FC410BDM Loop Powered Beam Detector Interface Module is contained on a double sided printed circuit board (PCB) which is fitted into a custom built fascia plate with a protective cover being fitted over the PCB, leaving only the connection terminals exposed. The fascia plate is then fitted onto a standard dual-gang back box with BESA fittings.

FC410CIM - Contact Input Module

The FC410CIM FC Addressable Contact Input Module is designed to monitor fire contacts such as extinguishing system control, ventilation control, fire door control etc. The FC410CIM can be configured as:

- Two spur circuits (Class B) monitoring multiple normally open contacts, with short circuit giving a fault output.
- Two spur circuits (Class B) monitoring single normally closed contacts, with short circuit giving a fault output.
- Two spur circuits (Class B) monitoring multiple normally open contacts, with short circuit giving an alarm.

FC410DIM - Detector Input Module

The Addressable FC410DIM provides the ability to connect and interface one or two zones of 24V dc 2-wire conventional detectors (non-addressable) to the Fire Alarm Controller.

The FC410DIM monitors the status of detectors and wiring to detectors and signals detector and wiring status back to the Controller.

FC410RIM - Relay Interface Module

The FC410RIM Relay Interface Module provides one volt-free relay changeover contact on a latching relay.

The relay is controlled by a command sent from the FC fire controller via the addressable loop. The relay state (activated, deactivated or stuck) is returned to the controller.

FC400CH - Addressable Carbon Monoxide + Heat Detector

The FC400CH carbon monoxide plus heat detector forms part of the FC400 Series Addressable Fire detectors.

The detector is intended to plug into the following:

- 5B 5" Universal Base.
- FC450IB 5" Isolator Base.
- FC430SB Low Power Sounder Base.
- FC430LPSB Loop Powered Addressable Sounder Base.
- FC430LPASB Loop Powered Addressable Sounder/Beacon Base.

The detector is designed to transmit, to a remote Fire Class controller, digital signals which represent status of the carbon monoxide and heat elements of the detector. Software within the controller is used to interpret the returned carbon monoxide and heat values to raise alarm or other appropriate response according to the type of detector configured in Fire Class Console.

801RIL - Remote LED Indicator

The 801RIL Remote Indicator is used where a detector LED is not visible ie, when the detector is mounted in a roof void, lift shaft etc. The 801RIL is mounted to a single gang electrical box and is supplied with 2 x M3.5 screws.

801HL - Remote LED Indicator

The 801HL Remote Indicator is used where a detector LED is not visible ie, when the detector is mounted in a roof void, lift shaft etc.

The 801HL provides a larger indicator for use in place of the 801RIL when longer distances are involved or in VdS influenced markets.

The 801HL can be mounted to any suitable flat surface and has fixing centres at 60 and 80mm.

HVR800-High Voltage Relay

The HVR800 High Voltage Relay Interface is a non-addressable multi-voltage relay module (operating from 24V dc, 24V ac, 120V ac and 240V ac).

The encapsulated HVR800 provides a 10 amp volt-free contact that can be used to extend the contact ratings of FC410RIM Addressable Relay Module applications.

A maximum of four HVR800s can be individually driven and controlled by an FC410MIO Small Addressable Multi-Input/Output module if all HVR800s are powered by 120V ac or 240V ac. For ac operation, no external dc power supply unit is required to operate the relay.

When used to switch 24V dc, the HVR800 must be provided with an external 24V dc supply which should be switched through the clean relay contacts of an FC410MIO or FC410RIM.

MP69-Duct Probe Unit

The MP69 Duct Probe units are designed to be installed in air conditioning supply and exhaust ducts for the purpose of monitoring the airflow for smoke and combustion products.

The Duct Probe Units are designed to accept and will operate satisfactorily with the 600 and FC400 Series detectors. The Duct Probe units are factory fitted with the FireClass Universal Base 5B.

FIRERAY 50/100-Optical Beam Smoke Detector

The Detector comprises a Transmitter and Receiver contained within one enclosure.

The Transmitter emits an infrared light beam that is reflected via a prism mounted directly opposite and with a clear line of sight. The reflected infrared light is detected by the Receiver and analysed.

The Detector has a maximum lateral detection defined by the local National Standard. As a guide a common lateral distance of 7.5m will be used in this guide. Use the latest beam detector standards EN54 part 12, VdS2095 or BS5839 part 1 for further guidance.

The optimal beam distance from the ceiling will be between 500mm and 600mm, again the Local National Standard will give guidance.

range: Fireray100 = 50-100 meter

Fireray50 = 5-50 meter

Coverage area: Fireray100 = up to 1500 sqm.

Fireray50 = up to 750 sqm.

FC410LPSY and FC410LPAV loop powered sounders and sounder-beacons

The FC410LP Series of Loop Powered Addressable Sounder/ Sounder-Beacons are designed to be driven from an FireClass control panel via the addressable loop. The FC410LP Series of sounders/sounder beacons consist:

FC410LPSYR: Sounder (indoor use) - red housing

FC410LPSYW: Sounder (indoor use) - white housing

FC410LPSY: Sounder IP65 (outdoor use) - red housing

FC410LPAVR: Sounder-Beacon (indoor use) - red housing

FC410LPAVW: Sounder-Beacon (indoor use) - white housing

FC410LPAV: Sounder-Beacon IP65 (outdoor use) - red housing

The sounder has two volume settings 'High' (103 dB \pm 3) or 'Low' (90 dB \pm 3).

The beacon has two flash rates 'Slow Flash' (1/2 Hz) or 'Fast Flash' (1 Hz).

The FC410LP devices are synchronised, but not synchronous with other FireClass sounders (FC410SNM) and beacons (FC430SAB).

The first flash of the beacon is synchronised with the start of the tone.

The FC410LP devices have a built in two port isolator.

FC430LPSB and FC430LPASB Loop Powered Addressable Sounder/Beacon Base

The FC430LP Series of Loop Powered Addressable Sounder/Sounder- Beacons are designed to be driven from an FC501 control panel via the addressable loop.

Tone, volume and flash rates are set in FireClass Console.

The sounder has four volume settings 'High' (90dB \pm 3), 'Mid High' (80 \pm 3dB), 'Mid Low' (70 \pm 3dB) or 'Low' (60dB \pm 3). The beacon has two flash rates 'Slow Flash' (1/2Hz) or 'Fast Flash' (1Hz). The FC430LP Series have a built-in line isolator.

FC410SNM Sounder Notification Module

The FC410SNM Sounder Notification Module is designed to provide an output, in response to a command signalled from a controller, to activate a number of polarised and suppressed sounders. The sounders are powered from an independent power supply and the module is capable of passing up to a maximum of 2A (eg, 24V dc 50mA company sounders or a mixture of different current rated sounders not exceeding a maximum current of 2A).

 *The possibility of the configuration of extinction, although present in the FC410SNM module, is not available for FC501 control panel.*

FC410TSM – door control module

The FC410TSM Door Control Module is designed to close a fire door in case of alarm or fault. The door is normally kept open by electromagnets. The door control module disconnects the electromagnets from power supply in order to allow the door to close. The FC410TSM has a relay changeover output and a monitored input. The FC410TSM contains an integrated line isolator and self-monitoring circuits (monitoring of communication with a panel, loop power monitoring), which enables the fire door to be closed when communication with a panel is lost for longer than 45s (\pm 5s) or the loop power drops below U_{min} =19V for more than 15s (\pm 5s). In addition, the FC410TSM monitors the external 24V supply.

FC410DDM – Universal fire and gas detector module

The FC410DDM provides the ability to connect and interface 2 zones of 20 V DC 2-wire conventional fire detectors, or two 4-20 mA signalling sensors, to the FireClass fire alarm controller. The FC410DDM monitors the status of the detectors and the wiring to the detectors and signals detector and wiring status back to the controller. The conventional detector circuits can be configured in one way: To monitor 1 or 2 Class B spur circuits The 4-20 mA signalling sensors may be one of two types:

- Current sinking
- Current sourcing.

FC410QIO Quad input output module

The module provides four monitored digital inputs and four potential free relay changeover outputs.

The outputs are monitored with parallel contacts of the relays. The outputs can be connected to an Auxiliary Voltage source and its voltage can be monitored. Additionally, all the outputs can be connected to the HVR800, for switching high power galvanic isolated loads. For more details refer to the HVR800 documentation. The module has an integral loop isolator. If this activates a yellow LED illuminates. The activation remains in place until the short is removed. The digital input monitoring and isolator functions are both configurable.

Maximum relay current: 2A.

Maximum relay voltage: 30V.

FC410QRM Quad relay module

The module provides four voltage free relay changeover outputs. The outputs are monitored, with parallel contacts of the relays. The outputs can be connected to an Auxiliary Voltage source and its voltage can be monitored. Additionally, all the outputs are configurable to the HVR (High Voltage Relay) mode, which allows you to connect up to four HVR800 modules for switching; for example 240V loads galvanically isolated.

The module has an integral loop isolator. If this activates a yellow LED illuminates. The activation remains in place until the short is removed.

Maximum relay current: 2A.

Maximum relay voltage: 30V.

FC410QMO Quad Monitored Output Module

The module comprises of four relays with selectable wiring supervision.

The output wiring is monitored for any short or open circuit. Spur and Loop configurations are supported.

The module has an integral loop isolator. If this activates a yellow LED illuminates. The activation remains in place until the short is removed.

SPECIFICATIONS

This specifications is for installers with knowledge of the control panels, and fire control panels in general. This chapter holds all the necessary installation details.

Technical features

Some of the technical features, regarding the terminals on the Main, are described in the following paragraph.

Control Panel	FC501-L/FC501-H
Main voltage	230 V \sim 50/60 Hz -15/+10%
Aux. Outputs Nominal Voltage	27.6V
Aux. Outputs Min. and Max. Voltage	19.0 ÷ 27.6V
Minimum output voltage	19.0Vdc \pm 5 %
Max current drawn	0.5A (FC501-L) 0.9A (FC501-H)
Ripple	1 %
Maximum internal resistance of the battery and associated circuitry	1 Ω
Temperature range	-5 to +40°C
Storage Temperature	-40 to +80°C
Operating Humidity	Up to 95% non-condensing
Dimensions (W*H*D)	335*369*115 mm
Weight	3 Kg (without batteries)

Table 10 FC501 Technical features

The following table shows the technical features of the Repeater FC500REP.

REPEATER	FC500REP
Operating voltage	27.6Vdc
Maximum current	80mA
Temperature range	-5 to +40°
Storage Temperature	-40 to +80 °C
Operating Humidity	Up to 95% non-condensing
Dimensions (W*H*D)	390x215x50 mm
Weight	2.05 Kg

Description of the terminals

The terminals of the Main board and Switching power supply, are described briefly in the Table 11: the standby (normal) status is the first, followed by the alarm status. Moreover, the Voltage present during the different operating conditions is indicated for each terminal, as well as the maximum current (in amps) that can circulate.

 Notes (1) and (2) are valid for the table 10.
Notes (3) and (4) are valid for the table:
" MAX WITHDRAWABLE CURRENT"

- 1)** For the power supply of the external devices. (see table 11).
- 2)** Connect a 3900 ohm resistor between the [+] and [-] terminals of the SC1, SC2 Outputs, if not used (see table 11).
- 3)** The sum of the currents of SC1 and SC2 must not exceed 500 mA.
- 4)** The sum of the currents of 24A and 24R must not exceed 500 mA.

Table of distribution of currents

FC501-L CONTROL PANEL	
SWITCHING POWER SUPPLY BAQ35T24 (Imax=1500mA)	
7 Ah BATTERY	$I_{load\ 80\% \text{ in } 24h} = (7 \times 0.8) / 24 = 233mA \rightarrow \mathbf{250mA}$
	$I_{for\ panel} = 1500 - 250 = \mathbf{1250mA}$
	Panel load distribution
	$I_{electronic} = 175mA$
	$I_{total\ LOOPS\ @40V^{(*)}} = 200mA \rightarrow 313mA\ @Vbattery$
	$I_{total\ OUTPUTS^{(*)}} = 550mA$
	$I_{FC500IP} = 100mA^{(**)}$
12Ah BATTERY	$I_{load\ 80\% \text{ in } 24h} = (12 \times 0.8) / 24 = 400mA \rightarrow \mathbf{400mA}$
	$I_{for\ panel} = 1500 - 400 = \mathbf{1100mA}$
	Panel load distribution
	$I_{electronic} = 175mA$
	$I_{total\ LOOPS\ @40V^{(*)}} = 200mA \rightarrow 313mA\ @Vbattery$
	$I_{total\ OUTPUTS^{(*)}} = 450mA$
	$I_{FC500IP} = 100mA^{(**)}$
$I_{residual} = 63mA$	

FC501-H CONTROL PANEL	
SWITCHING POWER SUPPLY BAQ60T24 (Imax=2500mA)	
12 Ah BATTERY	$I_{load\ 80\% \text{ in } 24h} = (12 \times 0.8) / 24 = 400mA \rightarrow \mathbf{400mA}$
	$I_{for\ panel} = 2500 - 400 = \mathbf{2100mA}$
	Panel load distribution
	$I_{electronic} = 175mA$
	$I_{total\ LOOPS\ @40V^{(*)}} = 400mA \rightarrow 625mA\ @Vbattery$
	$I_{total\ OUTPUTS^{(*)}} = 1150mA$
	$I_{FC500IP} = 100mA^{(**)}$
38Ah BATTERY	$I_{load\ 80\% \text{ in } 24h} = (38 \times 0.8) / 24 = 1267mA \rightarrow \mathbf{1300mA}$
	$I_{for\ panel} = 2500 - 1300 = \mathbf{1200mA}$
	Panel load distribution
	$I_{electronic} = 175mA$
	$I_{total\ LOOPS\ @40V^{(*)}} = 200mA \rightarrow 313mA\ @Vbattery$
	$I_{total\ OUTPUTS^{(*)}} = 450mA$
	$I_{FC500IP} = 100mA^{(**)}$
$I_{residual} = 163mA$	

NOTE: (*) $I_{total\ LOOPS}$ is the sum of the currents absorbed on the three loops;

$I_{total\ OUTPUTS}$ is the sum of the currents drawn by the terminals SC1, SC2, 24A, 24R, 24V-RS485.

If the FC500IP module will not be used, the relative amount of current (100mA) can be taken from the SC1, SC2, 24A, 24R, 24V-RS485 terminals.

 The notes and the table "Max withdrawable current" apply to the two models of control Panels.

MAX WITHDRAWABLE CURRENT	
TERMINALS	max Current
SC1	500mA
SC2	500mA
24A	500mA
24R	500mA
24V-RS485	500mA

TERM.	DESCRIPTION	v(V)	i(A)
MAIN BOARDS			
+L1-LEFT	(+)Loop 1-Positive signal, left side. (-)Loop 1-Negative signal (return), left side	—	—
+L1-RIGHT	(+)Loop 1-Positive signal, right side. (-)Loop 1-Negative signal (return), right side	—	—
+L2-LEFT	(+)Loop 2-Positive signal, left side. (-)Loop 2-Negative signal (return), left side.	—	—
+L2-RIGHT	(+)Loop 2-Positive signal, right side. (-)Loop 2-Negative signal (return), right side.	—	—
+L3-LEFT	(+)Loop 3-Positive signal, left side. (-)Loop 3-Negative signal (return), left side.		
+L3-RIGHT	(+)Loop 3-Positive signal, right side. (-)Loop 3-Negative signal (return), right side.		
SH	Terminal for connection of the shield of cables		
+RS485-	SERIAL BUS. Terminals to connect the FC500REP and FC500MFI modules	—	—
[+] [24R]	24 V RESET ABLE AUXILIARY POWER SUPPLY: negative present on terminal [+]; positive present on terminal [24R].	27.6 0	0.5(1) —
[+] [24A]	24 V AUXILIARY POWER SUPPLY: negative present on terminal [+]; positive present on terminal [24A].	27.6 0	0.5(1) —
[LE] [LI] [⊥]	Terminal for connection of the external telephone line Terminal for connection of the internal telephone line Terminal for connection of the Earth cable		
[NC] [NO] [C] FIRE	FIRE ALARM OUTPUT - Non-Supervised: standby → [C] connected to [NC] with [NO] open; in the event of ALARM → [C] connected to [NO] with [NC] open	—	—
[NC] [NO] [C] FAULT	FAULT ALARM OUTPUT - Non-Supervised: standby → [C] connected to [NC] with [NO] open in the event of fault → [C] connected to [NO] with [NC] open	—	—
+BAT-	BATTERY CONTROL PANEL POWER SUPPLY	27.6	
[OC1]... [OC2]	Programmable Outputs(Open collector)- Silenceable-Bypassable (Disabled)-Supervised (The polarity is not programmable)	27.6	
[MIK] [SPK] [BLK] [RED]	FUTURE USE		
[SC1] [SC2]	(Programmable, SC2 only),Supervised, Silenceable, Bypassable (Disabled) ALARM Outputs: Panel in Standby → negative on [+] terminal; positive 27.6V on [-] terminal Panel in Alarm → positive 27.6V on [+] terminal; negative 0 V on [-] terminal	—	(2)

Table 11 Terminals description



© FireClass

via Gabbiano 22, Z. Ind. S. Scolastica
64013 Corropoli (TE), Italy

Hillcrest Business Park Cinderbank Dudley West Midlands
DY2 9AP United Kingdom

www.fireclass.net

ISTISFKEFC501 1.0 030413 V10