

CDT-180 COLOR DECT

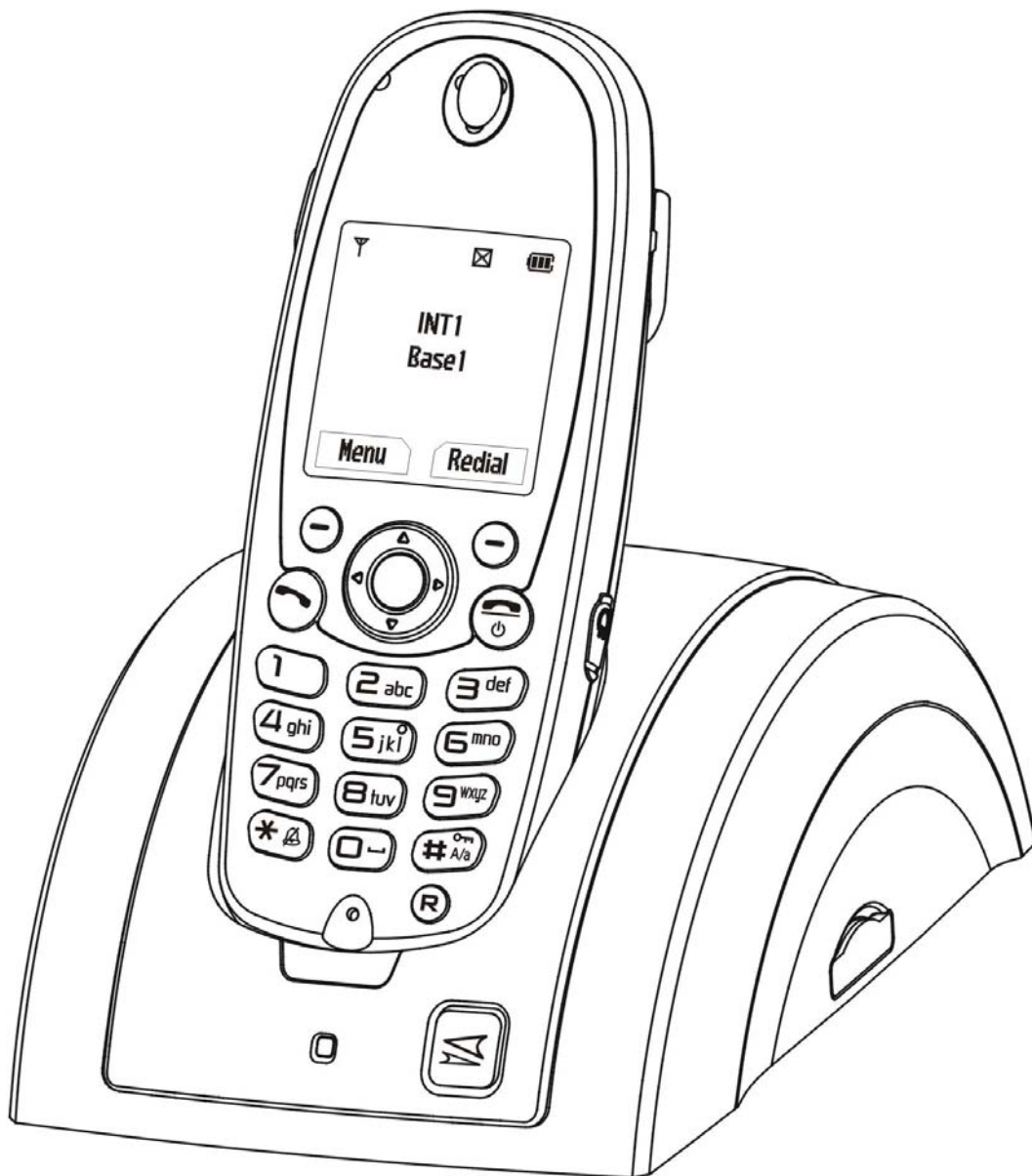

User Guide

Preliminary

Quick guide

- **Switch Handset On / Off** Press **END** key
- **Keypad Lock** Press **#** key
- **Unlock the Keypad** Press **1** and then **9** key
- **Making an External Call** Enter the number, then press **TALK** key
- **Answering a Call** Press any key except **END** key
- **Muting the ringing during an Incoming Call** Press **Mute** key
- **Redialing a Number** Press **Redial** key and then find the redial number using **UP / DOWN** key and then press **TALK** key
- **Dialing using Phonebook** Press **DOWN** key, and select entry with number key (if necessary, use **UP / DOWN** key), and then press **TALK** key
- **Adjusting the Earpiece Volume / Speaker Volume** Use **UP / DOWN** key during a call

Safety Precautions

- For the Handset charging, use only approved rechargeable batteries (Battery 1.2V 600mAh Ni-MH AAA size). Never use other batteries or conventional alkaline batteries. They could lead a short circuit or destroy the battery casing.
- Replace only with the same or equivalent type recommended by the manufacturer.
- Rechargeable batteries became warm during loading (charging the handset); this is a normal process and harmless.
- Do not try to use any power supply except the one provided.
- Do not use in the rain, near a bath or with wet hands.
- Do not allow the charging contacts to come into contact with conductive materials.
- It is recommended that you disconnect the base unit from the mains power and telephone line socket during a thunderstorm.
- This is a rechargeable product and it is normal that a certain amount of heat will be generated in its day to day operation. While this is safe, it is recommended that this product is not placed on antique, veneered or wooden surfaces.
- To clean the product, use a damp (not wet) cloth or antistatic wipe. Never use a dry cloth as this may cause a static shock. Never spray cleaning fluid directly onto the handset and base unit.
- Note for emergency calls:
Telephone calls are impossible if the main power fails.

Contents

Quick guide	2
Safety Precautions	3
Getting Started	6
Outline	6
Display symbols for handset	8
Preparing for use	9
Switching the handset on and off	10
Switching keypad protection on and off	10
Using the menus	10
Using headset	10
General functions	11
Making and answering an external call	11
Speaker on and handsfree	12
Receiver and speaker volume	12
Notebook	13
Out of range warning	13
Paging	13
Redialing	14
Dialing a number from the redialing list	14
Pre-dialing using the redial list	14
Copying a number to the phone book	14
Deleting a number from the redialing list	15
Deleting the redialing list	15
Phone book	16
Storing an entry	16
Dialing a number from the phone book	17
Displaying a number from the phone book	17
Editing an entry	17
Deleting an entry	18
Deleting the phone book	18
Displaying the memory status	18
Copy from SIM card (Option)	18
Registering handsets	32
Registering handsets	32
Operating several handsets	33
Making and answering an internal call	33
Answering a waiting call	33
Transferring a call	34
Call brokering	34
Conference call	34
Handset settings	35
Ringer volume	35
Ringer melody	35
Key click	35
Alarm clock	35

Contrast	36
Wall Paper	36
Automatic answering	37
Selecting another Charger	37
Entering the handset name	37
Language	37
Changing the handset PIN	38
Factory settings for the handset	38
Reference	44
Troubleshooting	44
Technical specifications	45
Menu Table	46

Getting Started

Outline

Handset

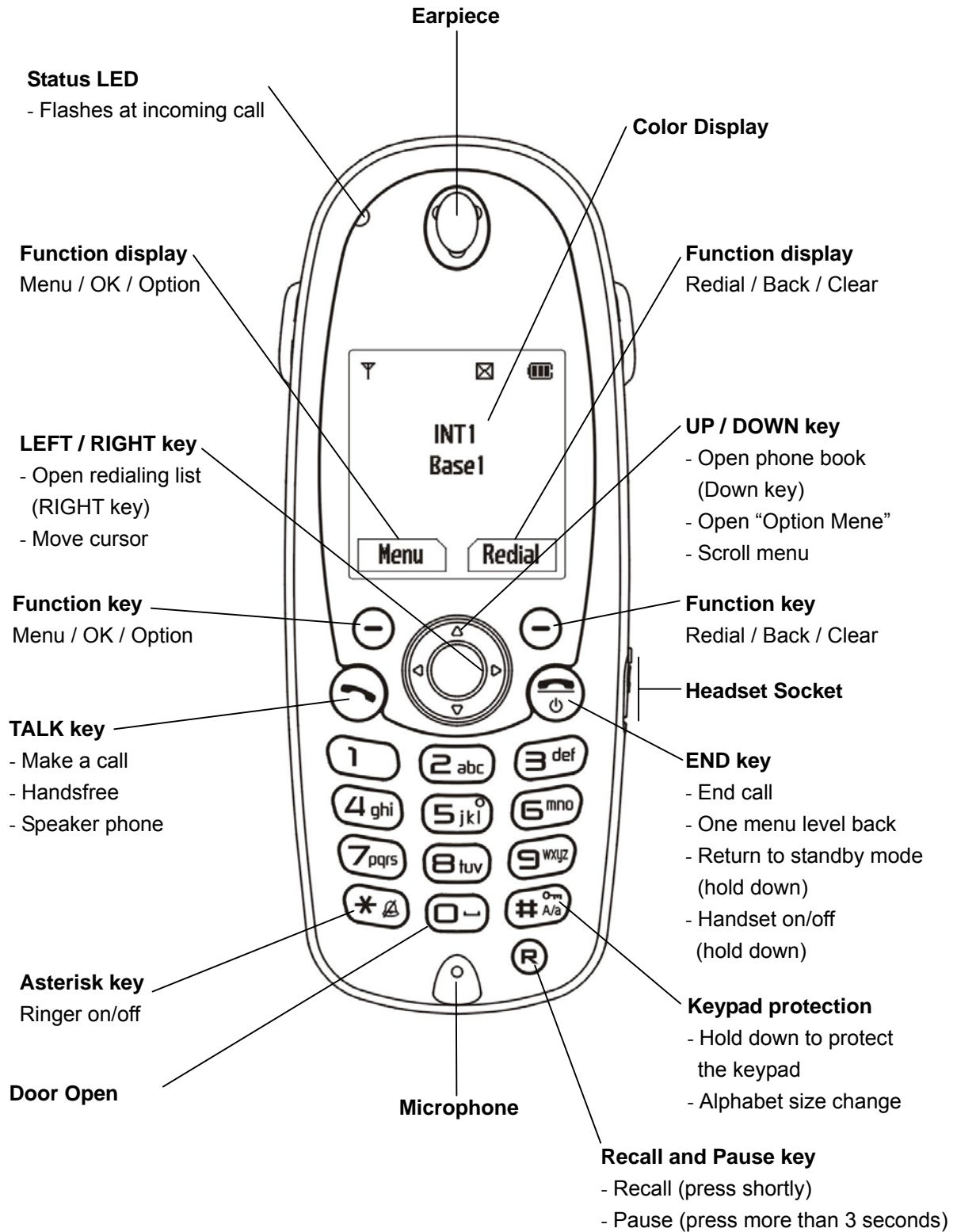

Charger

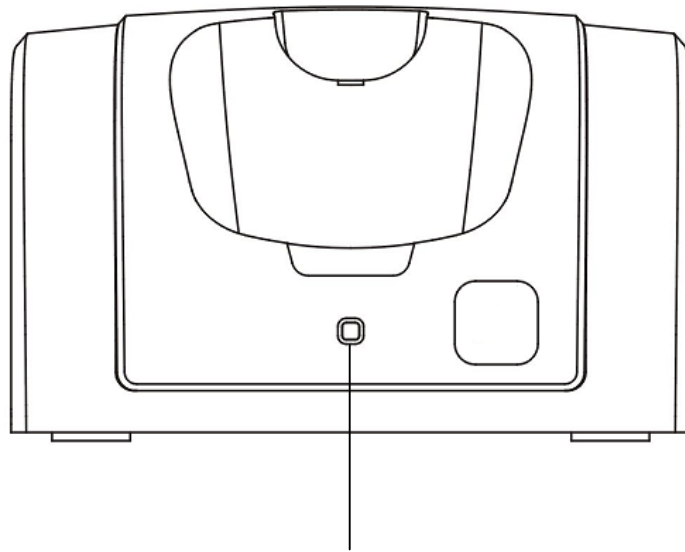





LED :
ON : Full Charged
Flashing : Charging

Belt Clip

Please insert and fix the belt Clip(packed with the product) into the small groove to be at the both side above handset display.
After fixing the belt clip into Handset , you can use Handset with comfortable way.

Display symbols for the handset

Symbols	On	Flashing
Communication symbol 	Connected to a Charger	Finding a Charger
Internal call symbol INT	Internal call is made	Internal call is held
Speaker symbol 	Speaker phone is activated	
External call symbol 	External call is made	External call is held
Bell off symbol 	Bell off of incoming call	
Battery symbol 	Batteries status	

Preparing for use

Installing the Charger

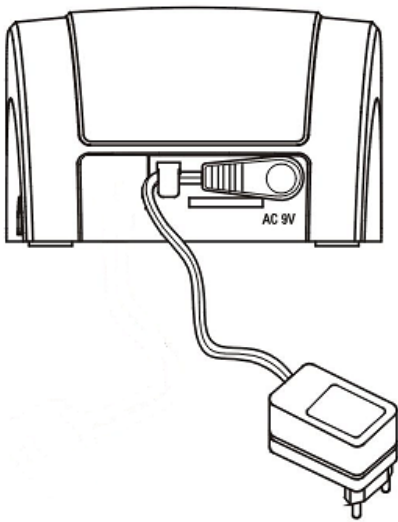

Range

Depending on the ambient conditions, the outdoor range is approx. 300 m. The indoor range is approx. 50 m depending on the construction of the building.

Connecting

1. Insert the small plug on power supply unit and the small plug on telephone cable into the appropriate sockets on the bottom of the Charger
2. Place cables in each cable duct

Installing the handset

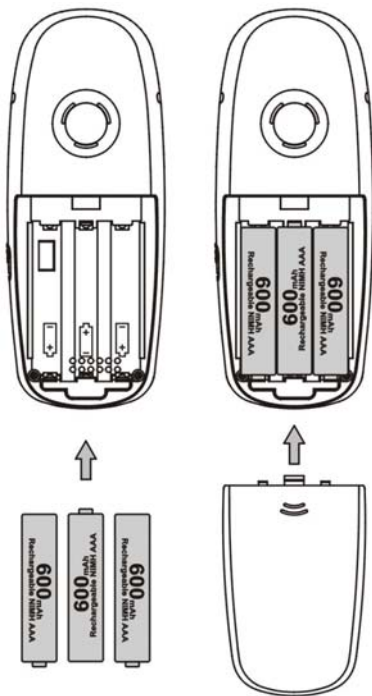

Inserting the batteries

1. Open battery compartment and insert included batteries. Make sure poles are correct.
2. To close, slide the cover onto the battery compartment until it closes tight.





Charging the batteries

The included batteries are not charged. To charge, place the handset in the Charger. You will hear a signal tone of the handset to confirm that the batteries are being charged.

The charging status symbol on the handset indicates the charging status of the batteries:

NOTE : Please charge the batteries 8hours at list just after you buy.

The time of full charging is 8 hours at list.

-  Batteries empty
-  Batteries 1/3 charged
-  Batteries 2/3 charged
-  Batteries full

Switching the handset on and off

The handset is activated as soon as the batteries have been installed.

To switch on/off, press the end key - you will hear the beep sound.

The handset also is switched on automatically when it is placed in the Charger. If the handset is switched on by placing in the Charger the charging status symbol is displayed.

Switching keypad protection on and off

You can protect the handset keypad if you are going to carry the handset in your pocket or bag. This prevents numbers being dialed by accident.

If there is an incoming call, the keypad is automatically unlocked and locked after the call has ended.

To lock, press **#** key - you will hear the confirmation beep.

To unlock, press 1 and then 9 keys.

Using the menus

Your telephone can be operated via menu. The menu offers access to all setting procedures and many of the telephone functions. Some menu items open a sub-menu after the selection of menu item.

Keys	Executed function
MENU	Call the menu or sub-menu.
OK	Confirm menu item function and select menu item.
Option	Call the option menu
Back	Back to the previous menu or state..
Clear	Delete the digit (use the edit state)
END	Cancel. Press shortly: Back to the previous menu or state. Hold down: Back to the standby state.
UP / DOWN	Scroll.

Using headset

With the headset, you can talk without using your hands. When you connect the headset to the headset jack on the right side of the handset, the headset operates in same way as the handset's earpiece and microphone. The button on the headset allows you to answer or end a call on the headset.

General functions

Making and answering an external call

Making an external call

Dialing with pre-dialing

When you make a call, you can enter the number and then press **TALK** key. This is called pre-dialing.

1. **Clear**: delete the digit one by one.
END: The phone number entry is aborted.
LEFT: move left the cursor.
RIGHT: move right the cursor.
2. Press **END** to end the call.
number entry.

- **Insert Pause**

Attach **Pause(P)** to number by press **R** key more than 2 seconds.

- **Insert Pause**

Attach **Flash(R)** to number by press **R** key shortly.

- **Using the phone book list**

1. Press **MENU**
2. Select the menu item **Phonebook List**.
3. Press **OK** to confirm.
4. If not empty, you can see entries to be entered in the phone book
5. Press **OK**, the number of the selected entry is attached with manually entered number.
6. Press **TALK**. The number is dialed.
7. Press **END** to end the call.

Dialing without pre-dialing

1. Press **TALK** and wait for the dial tone.
2. Dial the number.
3. Press **END** to finish the call.

Answering an external call

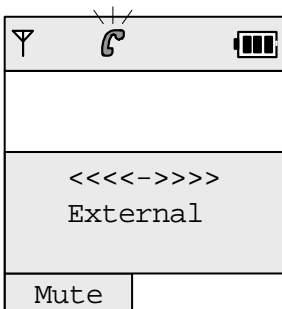

Your handset rings.

1. To answer the call, press any key except **Silent** soft key or remove the handset from the Charger (Automatic answering function).
2. Press **END** to end the call.

If you do not want to answer the call, you can switch off the ringing of the handset by pressing **Silent** soft key. You can press **TALK** if you still want to answer the call.

Displaying the call time

During an external call, the handset displays the call time.

Speaker on and handsfree

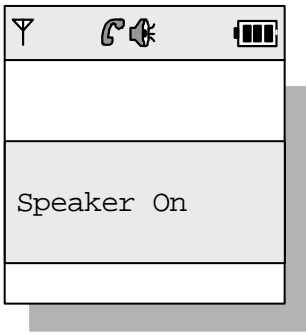

On the speaker on mode, other persons in the room can listen, in handsfree mode you put down the handset and have your hands free to make notes for example.

By repeatedly pressing **TALK** you switch to speaker on mode (once) and handsfree (twice) and back during the call. Switching from normal to speaker on and handsfree mode is shown briefly on the display. The speaker symbol is also visible in both operation modes.

Speaker on and handsfree mode are possible during an external call and internal call also.

Notes: You can only switch to speaker on and handsfree operation when the battery symbol has at least one segment.

Receiver and speaker volume

Receiver and speaker volume (in handsfree or speaker on mode) can be adjusted. Three volume levels for the receiver and six volume levels for speaker are possible.

Adjusting the receiver volume

With **UP** / **DOWN** you can adjust the receiver volume during the call. The selected receiver volume is stored.

Adjusting the speaker volume

With **UP** / **DOWN** you can adjust the speaker volume during the call in handsfree or speaker on mode. The selected speaker volume is stored. The volume is stored separately in speaker on and handsfree mode.

Notebook

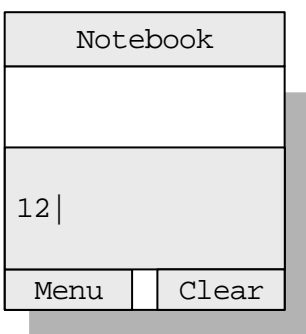

You can note with number in the redial memory during the call.

1. Press **MENU**.
2. Select the menu item **Notebook**.
3. Press **OK** to confirm. The input field is opened with the selected number.
4. Enter the number. Correct the number if necessary.
 - Clear:** delete the digit.
 - LEFT:** move left the cursor.
 - RIGHT:** move right the cursor.
5. Press **Option**.
6. Select **Save** and press **OK** to store.

Notes: You can see the entered number of using Notebook by using redial function.

Out of range warning

If the handset is out of range from the Charger during the call, the handset warns you with short beeping sounds.

Redialing

The handset automatically saves the last ten phone numbers dialed.

Dialing a number from the redialing list

Redial	
9P123456	
1234567890 01697330516	
Option	Back

1. Press **Redial** or **RIGHT** to open the redialing list. If not empty, last number is displayed.
2. Select the desired phone number using **UP / DOWN** key.
3. Press **TALK** to dial the selected number.

You can also open the redialing list during an external call by pressing **RIGHT**.

Pre-dialing using the redial list

The selected number is displayed with pre-dialing mode.

1. Press **Redial** or **RIGHT** to open the redialing list in standby mode. If not empty, last number is displayed.
2. Select the desired phone number.
3. Press **Option** to open sub-menu.
4. Select **Display Number**.
5. Press **TALK** key to display the selected number with pre-dialing mode.

Copying a number to the phone book

Redial	
Display Number	
Copy to PB	
Delete Entry Delete List	
OK	Back

1. Press **Redial** or **RIGHT** to open the redialing list. If not empty, last number is displayed.
2. Select the desired phone number.
3. Press **Option** to open sub-menu.
4. Select **Copy To PB**.
5. Press **OK** to confirm. The input field is opened in which you can enter a name.
6. Enter the name.
 - Clear**: delete the digit.
 - LEFT**: move left the cursor.
 - RIGHT**: move right the cursor.
7. Correct the number if necessary.
 - Clear**: delete the digit.
 - LEFT**: move left the cursor.

RIGHT: move right the cursor.

8. Press **Option**
9. Select **Save** and Press **OK** to Store.

Deleting a number from the redialing list

Redial	
Display Number Copy to PB	
Delete Entry	
Delete List	
OK	Back

1. Press **Redial** or **RIGHT** to open the redialing list. If not empty, last number is displayed.
2. Select the desired phone number.
3. Press **Option** to open sub-menu.
4. Select **Delete Entry**.
5. Press **OK** to delete.

Deleting the redialing list

Redial	
Display Number Copy to PB Delete Entry	
Delete List	
OK	Back

1. Press **Redial** or **RIGHT** to open the redialing list. If not empty, last number is displayed.
2. Select the desired phone number.
3. Press **Option** to open sub-menu.
4. Select **Delete List** and press **OK**.
5. Displayed "**Delete All Entries ?**"
6. Press **OK** to delete all entries.

Phone book

Phonebook List	
hykim	
abc Eidicom	
Option	Back

You can store up to 100 telephone numbers. One entry in the phone book consists of the name of 15 characters and the number of 30 digits.

The entries are sorted in the following sequence:

1. Space:
2. Digits: 0 – 9
3. Letters (alphabetical)
4. Other characters

Entering names

Use the numeric keys to enter names

To insert lower letters, press the **#** key. To revert to upper case letters, press the **#** key again.

Press the corresponding key repeatedly:

	1x	2x	3x	4x	5x	6x	7x	8x	9x	10x	11x	12x	13x
0	SP	0	?	!	¿	¡	.	,	“	’	:	;	
1	1	@	€	£	\$	¥	¤	&	§	µ	°	÷	
2	A	B	C	2	À	Á	à	Â	Æ	Ä	Ç		
	a	b	c	2	à	á	à	â	æ	ä	ç		
3	D	E	F	3	Ď	É	È	Ê	Ë				
	d	e	f	3	ď	é	è	ê	ë				
4	G	H	I	4	Ĝ	Í	Ì	Î	Ï				
	g	h	i	4	ĝ	í	ì	î	ï				
5	J	K	L	5	Ł								
	j	k	l	5	ł								
6	M	N	O	6	Ń	Ñ	Ó	Ö	Ò	Ô	Ø		
	m	n	o	6	ń	ñ	ó	ö	ò	ô	ø		
7	P	Q	R	S	7	Ś	Ş	ß					
	p	q	r	S	7	ś	ş	ß					
8	T	U	V	8	Ü	Ú	Ù	Û					
	t	u	v	8	ü	ú	ù	û					
9	W	X	Y	Z	9	Ý	Ž	Ž					
	w	x	y	z	9	ý	ž	ž					
*	*	#	+	-	/	%	=	()	<	>	\	_	

Storing an entry

1. Press **MENU**.
2. Select **Phonebook** and press **OK**.
3. Press **Option** to open sub menu.
4. Select **Add Entry** and press **OK**.

Add Entry	
Name	
Number	
Option	A Back

- Input name up to 15 letters and then press down key to input telephone number.
Clear: delete the digit.
LEFT: move left the cursor.
RIGHT: move right the cursor.
- Press **Option**.
- Select **Save** and press **OK** to store.

Dialing a number from the phone book

- Press **DOWN** in standby mode, the phone book is opened directly.
- Select entry.
- Press **TALK**. The number is dialed.

Displaying a number from the phone book

The number of the entry is displayed with pre-dialing mode.

- Press **MENU** in standby mode
(If you press **DOWN** in standby mode, the phone book is opened directly.)
- Select **Phonebook** and press **OK**.
- Select entry.
- Press **Option** to open sub menu.
- Select **Display Number**.
- Press **OK** to display the number with pre-dialing mode.

Editing an entry

Edit Entry	
Hykim	
1234567	
Option	a Clear

- Press **MENU**.
(If you press **DOWN** in standby mode, the phone book is opened directly.)
- Select entry.
- Press **Option** to open sub menu.
- Select **Edit Entry** and press **OK**.
- Edit the name and press **Down**.
LEFT: move left the cursor.
RIGHT: move right the cursor.
- Edit the number.
Clear: delete the digit.
LEFT: move left the cursor.
RIGHT: move right the cursor.
- Press **Option**.
- Select **Save** and Press **OK** to store.

Deleting an entry

1. Press **MENU**.
(If you press **DOWN** in standby mode, the phone book is opened directly.)
2. Select **Phonebook** and press **OK**.
3. Select entry.
4. Press **Option** to open sub menu.
5. Select **Delete Entry**.
6. Press **OK** to delete.

Deleting the phone book

Phonebook	
Display Number	
Add Entry	
Edit Entry	
Delete Entry	
Delete List	
OK	Back

1. Press **MENU**.
(If you press **DOWN** in standby mode, the phone book is opened directly.)
2. Select **Phonebook** and press **OK**.
3. Press **Option** to open sub menu.
4. Select **Delete List** and press **OK**.
5. Display "**Delete All Entries ?**"
6. Press **OK** to delete all entries.

Displaying the memory status

Memory Status	
000/100	
OK	Back

1. Press **MENU**.
(If you press **DOWN** in standby mode, the phone book is opened directly.)
2. Select **Phonebook** and press **OK**.
3. Press **Option** to open sub menu.
4. Select **Memory Status**.
5. Press **OK**. The number of phone book entries is displayed.

Registering handsets

Registering handsets

Register	
Base 1	
OK	Back

In order to connect a handset to a Charger, the handset must be registered to that Charger. Press **MENU**.

1. Select **Handset** and press **OK**.
2. Select **Register** and press **OK**.
3. Press **OK**.
4. Enter the Charger PIN and press **OK**. (Factory setting for PIN: 0000).
5. Press **MENU** button on Wall PAD.
6. Search **RF Register Mode** and then press **OK** on Wall PAD.
7. Wait until the free handset numbers are displayed.

- Select the handset number with the appropriate numeric keys.
Now, the handset is registered to Wall PAD.

Operating several handsets

You can operate up to 4 handsets on your Charger.

In addition to an internal call between 2 handsets an external call can be held simultaneously with a third handset.

Making and answering an internal call

Making an internal call

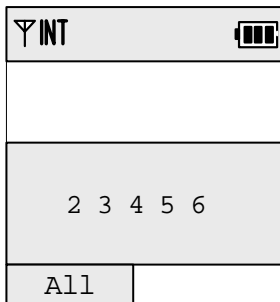

- Press **MENU**.
- Select **INT Call** and press **OK**.
- Enter the handset number.
If you want to call all handset, press **All**.

Answering an internal call

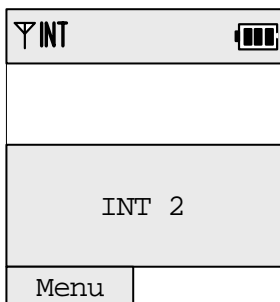

Your handset rings.

- To answer the call, press any key except **END** or remove the handset from the Charger (Auto Talk function).
- Press **END** to end the call.

Answering a waiting call

If an external call is received during an internal call, the call waiting tone is heard in both handsets.

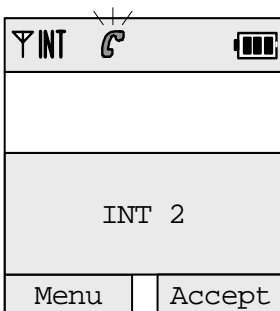

To answer the call, press **Accept**. The internal call is put on hold. Your handset is connected to the external caller.

You can make conference call during this state. Please see **Conference call** section.

Transferring a call

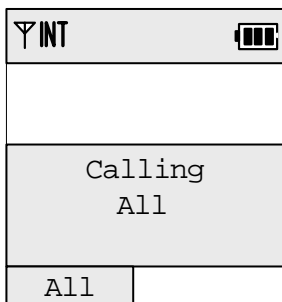

You can transfer an external call to another handset.

1. Press **MENU**.
2. Select **INT Call** and press **OK**.
3. Enter the handset number.
If you want to call all handset, press the **All** key
4. When the called party answers, press **END** to transfer the call

Note: Instead of announcing the call, you can immediately press **END**. If the called party does not answer the call goes automatically back to you.

Conference call

A conference call is possible between one external and two internal parties.

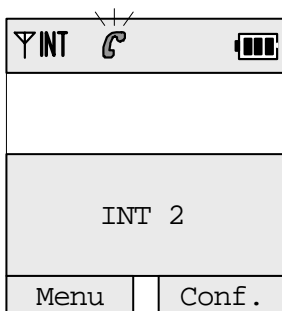

Making a conference call

You must make an external call first.

1. Press **MENU**.
2. Select **INT Call** and press **OK**.
3. Enter the handset number.
If you want to call all handset, press **All**.
4. Press the **Conf.** to make a conference call.

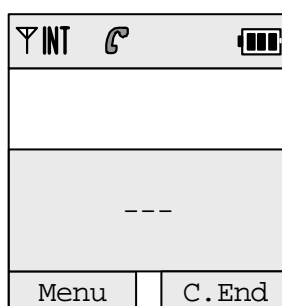

Ending a conference call

If you press **C.End** to end the conference call, the connection to the external party is maintained and the internal call is placed on hold.

If you press **END** to end the conference call, your handset returns to the standby mode and the connection to the external party is maintained with the other internal party.

Handset settings

Ringer volume

Five ringer volumes are possible for the handset. Ringer off also is available.

1. Press **MENU**.
2. Select **Handset Set** and press **OK**.
3. Select **Ringer Set** and press **OK**.
4. Select **Ringer Volume** and press **OK**.
5. Select the desired volume (Off, 1~5).
6. Press **OK** to save.

Ringer melody

1. Press **MENU**.
2. Select **Handset Set** and press **OK**.
3. Select **Ringer Set** and press **OK**.
4. Select **Ringer Melody** and press **OK**.
5. Select the desired melody (From 1~17).
6. Press **OK** to save.

Key click

Key Click	
On	√
Off	
OK	Back

Key click is the sound you hear each time you press a key. This feature can be enabled or disabled.

1. Press **MENU**.
2. Select **Handset Set** and press **OK**.
3. Select **Ringer Set** and press **OK**.
4. Select **Key Beep** and press **OK**.
5. Select **On** or **Off**.
6. Press **OK** to confirm.

Contrast

Adjustment LCD contrast.

1. Press **MENU**.
2. Select **Handset Set** and press **OK**.
3. Select **Contrast** and press **OK**.
4. Scroll with **UP / DOWN**.
5. Press **OK** to save.

Notes: The illumination of the handset can be only lighted up when the battery symbol has at least one segment.

Wall Paper

You can select the wall paper.

1. Press **MENU**.
2. Select **Handset Set** and press **OK**.

3. Select **Contrast** and press **OK**.
4. Scroll with **UP / DOWN**.

Automatic answering

Auto Answer	
On	√
Off	
OK	Back

When this function is activated you can remove the handset from the Charger to receive a call.

1. Press **MENU**.
2. Select **Handset Set** and press **OK**.
3. Select **Auto Answer** and press **OK**.
4. Select **On** or **Off**.
5. Press **OK** to save.

Entering the handset name

Handset Name	
Hy	
OK	Clear

You can assign a name of 8 characters for the handset. If the name is entered, the name is displayed on standby mode.

1. Press **MENU**.
2. Select **Handset Set** and press **OK**.
3. Select **Handset Name** and press **OK**.
4. Enter the name.
 - Clear**: delete the digit.
 - LEFT**: move left the cursor.
 - RIGHT**: move right the cursor.
 - #**: Select capital letter or small letter
5. Press **OK** to store.

Language

1. Press **MENU**.
2. Select **Handset Set** and press **OK**.
3. Select **Language** and press **OK**.
4. Select the desired language and press **OK** to confirm.

Note: Depending on the country version of this unit.
The display languages are different.

Changing the handset PIN

Enter PIN	

Clear	

To protect the handset settings from unauthorized access you should change the handset PIN (factory setting: 0000) to a PIN that only you know.

1. Press **MENU**.

2. Select **Handset Set** and press **OK**.
3. Select **Handset PIN** and press **OK**.
4. Enter the current handset PIN (factory setting: 0000).
5. Enter the new handset PIN (4 digits).
6. Reenter the new handset PIN to verify. If match the new handset PIN is saved.

Factory settings for the handset

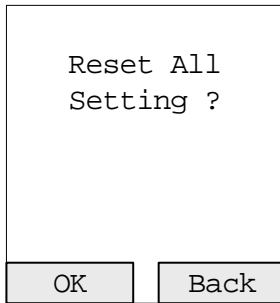

The phone book and the handset name are not deleted when you reset the handset.

1. Press **MENU**.
2. Select **Handset Set** and press **OK**.
3. Select **Default Set** and press **OK**.
4. Enter the handset PIN (factory setting: 0000).
5. Press **OK** to confirm.

Function	Factory Setting
Receiver volume	2
Group listening volume	4
Handsfree volume	4
Ringer volume	4
Ringer melody	12
Key click	On
Back light	On
Automatic answering	On
Language	Local
Handset PIN	0000

Special Function with Wall PAD

This DECT Phone work with Home Automation Device especially some of Commax products. Therefore some functions are different with normal DECT phone.

On line with Door phone

1. When visitor call with Door Phone, your handset rings.
2. To answer the call, press any key except **Silent** soft key or remove the handset from the Charger (Automatic answering function).
3. Press **END** to end the call.

NOTE : The time of talk is for 1minute. After 1 minute, you can hear the beep of end the call.

Open the Door

1. During the on line with Door Phone, press '0" button.
2. "Open Relay" on Door works, and then the Door is opened.

Answering an Inter-phone

1. When someone call with at the other room, your handset rings.
2. To answer the call, press any key except **Silent** soft key or remove the handset from the Charger (Automatic answering function).

NOTE : The time of talk is for 3minute. After 3 minute, you can hear the beep of end the call. It's not available to call other room units whit handset.

On line with Door Phone & Inter-phone

1. During on line with Door phone & Inter-phone, you can hear beep sound
2. If you want to answer the external call, press END key to end of on line with Door phone & Inter-phone, and untill wait to hear beep sound and then press TALK button.

NOTE : DECT need the time to detecting a ring signal, so reaction is little late than Wall PAD.

Reference

Trouble shooting

Symptom	Cause	Remedy
No display.	<ul style="list-style-type: none"> ✓ Handset not switched on. ✓ Battery empty. 	<ul style="list-style-type: none"> ✓ Handset switches on. ✓ Put handset on the base unit for charging batteries.
No allocation of the switched line.	<ul style="list-style-type: none"> ✓ The telephone connection cable is not correctly put. ✓ The power connection cable is not correctly put. ✓ The switched line is occupied by another handset. 	<ul style="list-style-type: none"> ✓ Plug in the telephone line cable into the base unit and also check the wall socket connection. ✓ Plug in the power ADAPTOR into the base unit. ✓ Wait until the switched line is free.
No radio communication to the base unit or handset is not ringing the bell.	<ul style="list-style-type: none"> ✓ Handset not registered at Base-station. ✓ The power connection cable is not correctly put into base. 	<ul style="list-style-type: none"> ✓ Handset Have to be registered at base unit. ✓ Plug in the power ADAPTOR into the base unit.
Handset is not ringing the bell.	<ul style="list-style-type: none"> ✓ Ringing volume is too low. 	<ul style="list-style-type: none"> ✓ Set the ringing volume high on the handset.
When dialing, the switched line disconnected.	<ul style="list-style-type: none"> ✓ Lock mode enable 	<ul style="list-style-type: none"> ✓ Check lock mode, and set lock mode disable.

Technical specifications

Wall PAD and handset

Standard	DECT/GAP
Number of channels	120 duplex channels
Channel spacing	1.728 MHz
Bit rate	1152 kbit/ sec
Duplex procedure	TDMA (time division multiple access procedure)
Voice coding	ADPCM (32kbit/s)
Modulation	GFSK
Radio frequency range	1.880 GHz to 1.900 GHz
Average transmission power	Approx. 10 mW (per channel)
Range	Up to 300 m outdoors Up to 50 m indoors

Power supply

Charger	Input: 100/110/120/220/230/240V, 50/60Hz Output: AC 9V, 300mA
Handset	Rechargeable Ni-MH 1.2V, 600mAh, AAA(x 3)
Handset operating time with full battery	Talk time: up to 10 hours Standby time: up to 100 hours
Permissible ambient temperature	0°C to 40°C
Permissible storage temperature	-20°C to 60°C

Dimensions (length x width x height)

Handset	(D) 28.0 x (W) 46.5 x (H) 115.0 mm
Charger	(D) 133.0 x (W) 81.5 x (H) 52.5 mm

Weight

Handset	111 g (Battery included)
Charger	148 g
Dialling procedure	DTMF and Pulse
Recall key function	Flash
Line cord	7 Feet Tel-line cord

Menu table

Standby mode

Phonebook	Display Number
	Add Entry
	Edit Entry
	Delete Entry
	Delete List
	Memory Status
Handset Set	Ringer Set
	Contrast
	Wall Paper
	Auto Answer
	Handset Name
	Language
	Register
	Handset PIN
	Default Set
INT Call	

On-line Menu

Insert Pause
Phonebook
INT Call
Tone
Notebook