IMPORTANT

This manual contains information on limitations regarding product use and function and information on the limitations as to liability of the manufacturer. The entire manual should be carefully read.

Now classified in accordance with ANSI/SIA CP-01-2000 (SIA-FAR)

Installation Manual

DSC[®]
Power 864[™]

S E C U R I T Y S Y S T E M

PC5020/PC502OCF Version 3.2
DLS-3 v1.3 and higher

WARNING Please Read Carefully

Note to Installers

This warning contains vital information. As the only individual in contact with system users, it is your responsibility to bring each item in this warning to the attention of the users of this system.

System Failures

This system has been carefully designed to be as effective as possible. There are circumstances, however, involving fire, burglary, or other types of emergencies where it may not provide protection. Any alarm system of any type may be compromised deliberately or may fail to operate as expected for a variety of reasons. Some but not all of these reasons may be:

■ Inadequate Installation

A security system must be installed properly in order to provide adequate protection. Every installation should be evaluated by a security professional to ensure that all access points and areas are covered. Locks and latches on windows and doors must be secure and operate as intended. Windows, doors, walls, ceilings and other building materials must be of sufficient strength and construction to provide the level of protection expected. A reevaluation must be done during and after any construction activity. An evaluation by the fire and/or police department is highly recommended if this service is available.

■ Criminal Knowledge

This system contains security features which were known to be effective at the time of manufacture. It is possible for persons with criminal intent to develop techniques which reduce the effectiveness of these features. It is important that a security system be reviewed periodically to ensure that its features remain effective and that it be updated or replaced if it is found that it does not provide the protection expected.

■ Access by Intruders

Intruders may enter through an unprotected access point, circumvent a sensing device, evade detection by moving through an area of insufficient coverage, disconnect a warning device, or interfere with or prevent the proper operation of the system.

■ Power Failure

Control units, intrusion detectors, smoke detectors and many other security devices require an adequate power supply for proper operation. If a device operates from batteries, it is possible for the batteries to fail. Even if the batteries have not failed, they must be charged, in good condition and installed correctly. If a device operates only by AC power, any interruption, however brief, will render that device inoperative while it does not have power. Power interruptions of any length are often accompanied by voltage fluctuations which may damage electronic equipment such as a security system. After a power interruption has occurred, immediately conduct a complete system test to ensure that the system operates as intended.

■ Failure of Replaceable Batteries

This system's wireless transmitters have been designed to provide several years of battery life under normal conditions. The expected battery life is a function of the device environment, usage and type. Ambient conditions such as high humidity, high or low temperatures, or large temperature fluctuations may reduce the expected battery life. While each transmitting device has a low battery monitor which identifies when the batteries need to be replaced, this monitor may fail to operate as expected. Regular testing and maintenance will keep the system in good operating condition.

■ Compromise of Radio Frequency (Wireless) Devices

Signals may not reach the receiver under all circumstances which could include metal objects placed on or near the radio path or deliberate jamming or other inadvertent radio signal interference.

■ System Users

A user may not be able to operate a panic or emergency switch possibly due to permanent or temporary physical disability, inability to reach the device in time, or unfamiliarity with the correct operation. It is important that all system users be trained in the correct operation of the alarm system and that they know how to respond when the system indicates an alarm.

■ Smoke Detectors

Smoke detectors that are a part of this system may not properly alert occupants of a fire for a number of reasons, some of which follow. The smoke detectors may have been improperly installed or positioned. Smoke may not be able to reach the smoke detectors, such as when the fire is in a chimney, walls or roofs, or on the other side of closed doors. Smoke detectors may not detect smoke from fires on another level of the residence or building.

Every fire is different in the amount of smoke produced and the rate of burning. Smoke detectors cannot sense all types of fires equally well. Smoke detectors may not provide timely warning of fires caused by carelessness or safety hazards such as smoking in bed, violent explosions, escaping gas, improper storage of flammable materials, overloaded electrical circuits, children playing with matches or arson.

Even if the smoke detector operates as intended, there may be circumstances when there is insufficient warning to allow all occupants to escape in time to avoid injury or death.

■ Motion Detectors

Motion detectors can only detect motion within the designated areas as shown in their respective installation instructions. They cannot discriminate between intruders and intended occupants. Motion detectors do not provide volumetric area protection. They have multiple beams of detection and motion can only be detected in unobstructed areas covered by these beams. They cannot detect motion which occurs behind walls, ceilings, floor, closed doors, glass partitions, glass doors or windows. Any type of tampering whether intentional or unintentional such as masking, painting, or spraying of any material on the lenses, mirrors, windows or any other part of the detection system will impair its proper operation.

Passive infrared motion detectors operate by sensing changes in temperature. However their effectiveness can be reduced when the ambient temperature rises near or above body temperature or if there are intentional or unintentional sources of heat in or near the detection area. Some of these heat sources could be heaters, radiators, stoves, barbecues, fireplaces, sunlight, steam vents, lighting and so on.

■ Warning Devices

Warning devices such as sirens, bells, horns, or strobes may not warn people or waken someone sleeping if there is an intervening wall or door. If warning devices are located on a different level of the residence or premise, then it is less likely that the occupants will be alerted or awakened. Audible warning devices may be interfered with by other noise sources such as stereos, radios, televisions, air conditioners or other appliances, or passing traffic. Audible warning devices, however loud, may not be heard by a hearing-impaired person.

■ Telephone Lines

If telephone lines are used to transmit alarms, they may be out of service or busy for certain periods of time. Also an intruder may cut the telephone line or defeat its operation by more sophisticated means which may be difficult to detect.

■ Insufficient Time

There may be circumstances when the system will operate as intended, yet the occupants will not be protected from the emergency due to their inability to respond to the warnings in a timely manner. If the system is monitored, the response may not occur in time to protect the occupants or their belongings.

■ Component Failure

Although every effort has been made to make this system as reliable as possible, the system may fail to function as intended due to the failure of a component.

■ Inadequate Testing

Most problems that would prevent an alarm system from operating as intended can be found by regular testing and maintenance. The complete system should be tested weekly and immediately after a break-in, an attempted break-in, a fire, a storm, an earthquake, an accident, or any kind of construction activity inside or outside the premises. The testing should include all sensing devices, keypads, consoles, alarm indicating devices and any other operational devices that are part of the system.

■ Security and Insurance

Regardless of its capabilities, an alarm system is not a substitute for property or life insurance. An alarm system also is not a substitute for property owners, renters, or other occupants to act prudently to prevent or minimize the harmful effects of an emergency situation.

Limited Warranty

Digital Security Controls Ltd. warrants the original purchaser that for a period of twelve months from the date of purchase, the product shall be free of defects in materials and workmanship under normal use. During the warranty period, Digital Security Controls Ltd. shall, at its option, repair or replace any defective product upon return of the product to its factory, at no charge for labour and materials. Any replacement and/or repaired parts are warranted for the remainder of the original warranty or ninety (90) days, whichever is longer. The original purchaser must promptly notify Digital Security Controls Ltd. in writing that there is defect in material or workmanship, such written notice to be received in all events prior to expiration of the warranty period. There is absolutely no warranty on software and all software products are sold as a user license under the terms of the software license agreement included with the product. The Customer assumes all responsibility for the proper selection, installation, operation and maintenance of any products purchased from DSC. Custom products are only warranted to the extent that they do not function upon delivery. In such cases, DSC can replace or credit at its option.

The warranty for international customers is the same as for any customer within Canada and the United States, with the exception that Digital Security Controls Ltd. shall not be responsible for any customs fees, taxes, or VAT that may be due.

To obtain service under this warranty, please return the item(s) in question to the point of purchase. All authorized distributors and dealers have a warranty program. Anyone returning goods to Digital Security Controls Ltd. must first obtain an authorization number. Digital Security Controls Ltd. will not accept any shipment whatsoever for which prior authorization has not been obtained.

Conditions to Void Warranty

This warranty applies only to defects in parts and workmanship relating to normal use. It does not cover:

- damage incurred in shipping or handling;
- damage caused by disaster such as fire, flood, wind, earthquake or lightning;
- damage due to causes beyond the control of Digital Security Controls Ltd. such as excessive voltage, mechanical shock or water damage;
- damage caused by unauthorized attachment, alterations, modifications or foreign objects;
- damage caused by peripherals (unless such peripherals were supplied by Digital Security Controls Ltd.);
- defects caused by failure to provide a suitable installation environment for the products;
- damage caused by use of the products for purposes other than those for which it was designed;
- damage from improper maintenance;
- damage arising out of any other abuse, mishandling or improper application of the products.

Items Not Covered by Warranty

In addition to the items which void the Warranty, the following items shall not be covered by Warranty: (i) freight cost to the repair centre; (ii) products which are not identified with DSC's product label and lot number or serial number; (iii) products disassembled or repaired in such a manner as to adversely affect performance or prevent adequate inspection or testing to verify any warranty claim. Access cards or tags returned for replacement under warranty will be credited or replaced at DSC's option. Products not covered by this warranty, or otherwise out of warranty due to age, misuse, or damage shall be evaluated, and a repair estimate shall be provided. No repair work will be performed until a valid purchase order is received from the Customer and a Return Merchandise Authorisation number (RMA) is issued by DSC's Customer Service.

Digital Security Controls Ltd.'s liability for failure to repair the product under this warranty after a reasonable number of attempts will be limited to a replacement of the product, as the exclusive remedy for breach of warranty. Under no circumstances shall Digital Security Controls Ltd. be liable for any special, incidental, or consequential damages based upon breach of warranty, breach of contract, negligence, strict liability, or any other legal theory. Such damages include, but are not limited to, loss of profits, loss of the product or any associated equipment, cost of capital, cost of substitute or replacement equipment, facilities or services, down time, purchaser's time, the claims of third parties, including customers, and injury to property. The laws of some jurisdictions limit or do not allow the disclaimer of consequential damages. If the laws of such a jurisdiction apply to any claim by or against DSC, the limitations and disclaimers contained here shall be to the greatest extent permitted by law. Some states do not allow the exclusion or limitation of incidental or consequential damages, so that the above may not apply to you.

Disclaimer of Warranties

This warranty contains the entire warranty and shall be in lieu of any and all other warranties, whether expressed or implied (including all implied warranties of merchantability or fitness for a particular purpose) and of all other obligations or liabilities on the part of Digital Security Controls Ltd. Digital Security Controls Ltd. neither assumes responsibility for, nor authorizes any other person purporting to act on its behalf to modify or to change this warranty, nor to assume for it any other warranty or liability concerning this product. This disclaimer of warranties and limited warranty are governed by the laws of the province of Ontario, Canada.

WARNING: Digital Security Controls Ltd. recommends that the entire system be completely tested on a regular basis. However, despite frequent testing, and due to, but not limited to, criminal tampering or electrical disruption, it is possible for this product to fail to perform as expected.

Out of Warranty Repairs

Digital Security Controls Ltd. will at its option repair or replace out-of-warranty products which are returned to its factory according to the following conditions. Anyone returning goods to Digital Security Controls Ltd. must first obtain an authorization number. Digital Security Controls Ltd. will not accept any shipment whatsoever for which prior authorization has not been obtained.

Products which Digital Security Controls Ltd. determines to be repairable will be repaired and returned. A set fee which Digital Security Controls Ltd. has predetermined and which may be revised from time to time, will be charged for each unit repaired.

Products which Digital Security Controls Ltd. determines not to be repairable will be replaced by the nearest equivalent product available at that time. The current market price of the replacement product will be charged for each replacement unit.

New Features

PC5200 Support	The PC5020 v3.1 and higher supports the new PC5200 Power Supply module. See PC5200 Power Supply Output Module, Pg 2.
PC5936 Support	The PC5020 v3.1 and higher supports the PC5936 15-station audio matrix module. See PC5936 Audio Interface Module, Pg 3.
SIA FAR	SIA False Alarm Reduction has been incorporated in this version. See the Quick Reference Chart SIA-FAR on the following page.
No Activity Arming (by Partition)	This feature enables the system (or partition) to arm if there is no zone activity for a programmed time period. See sections [191]-[198] - No-Activity Timer (Partition 1-8), Pg 30.
Programmable Auto-arm Pre-Alert Timer	The Auto- arm Pre-alert Time is now programmable. The default value for this timer has been extended to 5 minutes. See Section [199] - Auto-arming Pre-Alert Time, Pg 30.
Periodic Test Transmission Exception	With this feature enabled, the panel will not send a test transmission if there has been any transmission received by the receiver within the programmed time. See Section [018] - Sixth System Option Codes, Option 1, Pg 27.
Cross Zoning	This feature requires two or more trips on a zone(s) specified as “cross zones” within a specified time before starting an alarm sequence. The Cross Zone option is programmable by zone via Attribute 9. See Section [018], Sixth System Option Codes, Option 6, Pg 28.
True Automatic Contact ID	When selecting Automatic Contact ID for reporting, the reporting code will represent how a zone is defined according to the SIA specification for Contact ID. If Automatic Contact ID is enabled, see Appendix A for reporting codes that will be used for each zone type.
Keypad Buzzer	When enabled and the system or Partition is in alarm, all assigned keypad buzzers will follow the bell output. When disabled, the keypad buzzers will only sound for buzzer type alarms. This option is off at default. See Section [018] - Sixth System Option Codes, Option 5, Pg 28.
New Zone Types	See Sections [001]-[004] - Zone Definitions, Pg 21. Zone Type 27 - Delayed 24 Hour Waterflow Zone Zone Type 28 - Instant 24 Hour Waterflow Zone Zone Type 29 - Auto Verified Fire Zone Zone Type 30 - Fire Supervisory Zone Zone Type 31 - Day Zone
Waterflow Silence Inhibit Option	This option affects the Instant Waterflow Zone and the Delay Waterflow Zone. This option does NOT allow the user to silence alarms, manually, automatically, or by a system reset until all waterflow zones are returned to their restored state. See Section [018] - Sixth System Option Codes, Option 4, Pg 28.
Verbal Door Chime and Verbal Alarm Support	This feature enables the Door Chime to verbally announce the Zone that has been violated instead of a series of beeps. See Section [018] - Sixth System Option Codes, Option 2&3, Pg 33. This feature is only available when using the ESCORT5580 v3.0 , and the PC5936 v1.0 . Refer to the Escort5580 v3.0 and PC5936 v1.0 Installation Manuals for further information.
Loop Response	The PC5020 v3.1 and higher can configure any or all onboard zones for 36 ms Loop Response (see Section [030] - Fast Loop Response, Pg 29).
T-Link	The PC5020 v3.2 supports the T-Link TCP/IP Network Communicator.

PC5020 Installer Programming Quick Reference Chart SIA False Alarm Reduction

Minimum requirement system for SIA-FAR Installations :

- **1 PC5020 Control panel**
- **2 Local annunciation devices**

The local annunciation devices may be any combination of the following keypads.

- **LCD5500Z**
- **PKP-LCD**
- **LCD5501Z**
- **PKP-ICN**

The following optional subassembly modules also bear the SIA FAR classification and may be used if desired:

PC5108 Zone Expander Module

Compatible initiating devices: Bravo200 series, 300 series, 400 series, 500 series, 600 series, AC-100, Encore300 series, Force200 series, 210 series, MN240.

PC5208 Low Current PGM Output Module

The following optional accessory modules also bear the SIA FAR classification and may be used if desired.

PC5204 Auxiliary Power Supply with PGM output ports

Escort5580/Escort5580TC

PC5400 Printer Module

Section Number	Installation Manual Section	Description
005	5.3	System Times: Access to Entry Delays and Exit Delay for each partition and Bell Time Out for the system.
009 – 011	5.3	Programmable Outputs: Access to PGM Output programming for the main board, PC5208 and PC5204 modules. Output Attributes in Section in Sections 501 – 514. Partition Assignments in Section 551 – 564.
014, Option 6	5.3	Audible Exit Beeps: Enables beeps from the keypad for the duration of Exit Delay.
018, Option 6	5.3	Cross Zoning: This option enables Cross Zoning for the entire system. Individual zones can be enabled for Cross zoning via Zone Attributes in Sections 101 – 164. Default = OFF
018, Option 7	5.3	Exit Delay Restart: Enables the Exit Delay Restart feature.
101 – 164	5.4	Zone Attributes: Access to zone attributes, such as, Audible Bell, Swinger Shutdown, Transmission Delay, and Cross Zone.
176	5.4	Cross Zone Timer: Access to the programmable Cross Zone timer.
304	5.6	Call Waiting Cancel Dialing String: Access to the Dialing sequence used to disable Call Waiting.
328, 6 th Entry	5.6	Cross Zone Reporting Code: Access to the reporting code for Cross Zone Alarm.
328, 7 th Entry	5.6	Burglary not Verified Reporting Code: Access to the reporting code for Burglary Not Verified.
328, 8 th Entry	5.6	Alarm Cancelled Reporting Code: Access to the reporting code for Alarm Cancelled.
348, 1 st and 2 nd Entries	5.6	Walk Test End and Begin Reporting Codes: Access to the reporting codes for Walk Test Begin and Walk Test End.
377, 1 st Entry	5.6	Swinger Shutdown for Alarms: Access to the Swinger Shutdown limit for zone alarms.
377, 4 th Entry	5.6	Communications Delay: Access to the programmable delay before communicating alarms.
377, 11 th Entry	5.6	Communications Cancel Window: Access to the programmable Communications Cancel window.
382, Option 2	5.6	Alarm Comms. During Walk Test: Enables Communication of zone alarms while installer Walk Test is active.
382, Option 3	5.6	Communications Cancelled Message: Enables the “Communications Cancelled” message display on all keypads.
382, Option 4	5.6	Call Waiting Cancel: Enables the use of the Call Waiting Cancel string in programmed in Section 304.
901	5.11	Installer Walk Test Mode: Enable/Disable Installer Walk Test mode. This mode can be used to test each zone on the system for proper functionality.
[*][5] Master Code 33rd and 34th Entries	4.1	Duress Code: Do not derive code from an existing Master/User code (eg., Master Code is 1234, the duress code should not be 1233 or 1235).
[*][6] Master Code Option 4	4.3	System Test: The system activates all keypad sounders, bells or sirens for 2 seconds and all keypad lights turn on. Refer to the <i>User Manual (part no. 29005909)</i> .

Caution

- For SIA FAR installations, only use modules / devices that are listed on this page.
- Fire Alarm Verification feature (Auto Verified Fire zone) is not supported on 2-wire smoke detectors zones. This feature may be enabled for 4-wire smoke detectors only.
- Call Waiting Cancel (Section 382 Option 4) feature on a non-Call Waiting line will prevent successful communication to the central station.
- All smoke detectors on the system must be tested annually by conducting the Installer Walk Test. Prior to exiting the walk test mode, a sensor reset must be conducted on the system, [*][7][2] to reset all latching 4-wire smoke detectors. Please refer to the smoke detector installation instructions on how to correctly test the detectors.

Notes

- Programming at installation may be subordinate to other UL requirements for the intended application.
- Cross zones have the ability to individually protect the intended area (e.g., motion detectors, which overlap).
- Cross zoning is not recommended for line security Installations nor is it to be implemented on exit / entry zones.
- There is a communication delay of 30 seconds in this control panel. It can be removed, or it can be increased up to 45 seconds at the option of the end user by consulting with the Installer.
- Do not duplicate any reporting codes. This applies for all communication formats other than SIA sending automatic programmed reporting codes.
- The control unit must be installed with a local sounding device and an off-premise transmission for SIA communication format.

Table of Contents

Commercial Burglary, Residential Fire and Burglary Applications

Commercial Fire Applications

Section 1: Introduction	1
1.1 About the PC5020 System	1
1.2 About the PC5020 Manual Set	1
1.3 Main Panel Specifications	1
1.4 Additional Devices	2
Section 2: Installation and Wiring	5
2.1 Installation Steps	5
2.2 Terminal Descriptions	5
2.3 Wire Routing for Power & Non-Power Limited	6
2.4 Keybus Operation and Wiring	6
2.5 Current Ratings - Modules & Accessories	6
2.6 Assigning Zones to Zone Expanders	7
2.7 Keypad Assignment	7
2.8 Confirming Module Supervision	8
2.9 Removing Modules	8
2.10 Zone Wiring	8
2.11 Keypad Zones	10
Section 3: How to Program	11
3.1 How to Enter Installer Programming	11
3.2 Programming Decimal Data	11
3.3 Programming Hexadecimal Data	11
3.4 Programming Toggle Options	11
3.5 Viewing Programming	12
Section 4: Keypad Commands	13
4.1 Arming and Disarming	13
4.2 [*] Commands	14
4.3 Function Keys	17
4.4 Global and Partition Keypad Operation	18
4.5 Features Available for the LCD5500Z	18
Section 5: Programming Sections	19
5.1 For the Record PWS Sect 1	20
5.2 Keypad Programming PWS Sect 2	20
5.3 Basic Programming PWS Sect 3	20
5.4 Advanced Programming PWS Sect 4	29

5.5 Partition & Zone Programming	30
5.6 Communicator Programming PWS Sect6	31
5.7 Downloading Options PWS Sect 7	41
5.8 Programmable Output Programming PWS Sect 8	42
5.9 International Programming PWS Sect 9	43
5.10 Module Programming PWS Sect 10	44
5.11 Special Installer Instructions PWS Sect 11	45

Section 6: Central & Remote Station Fire Installation Instructions	47
6.1 Introduction	47
6.2 Hardware Description and Specifications	47
6.3 Compatible Devices	47

Section 7: Fire Monitoring Zone Types	49
7.1 Partitions and Fire System Configuration	49
7.2 Fire Zones	49
7.3 Auto Verify Fire	49
7.4 Waterflow Zone	49
7.5 PC5700 Zones	50
7.6 Four-Wire Smoke Detector Zones	50
7.7 Two-Wire Smoke Detector Zones	50
7.8 Fire Supervisory Zone	50

Section 8: Fire System Operation	51
8.1 Manual Signal Silence	51
8.2 Automatic Signal Silence (Bell Time-out)	51
8.3 Manual Sensor Reset ([*][7][2])	51
8.4 Subsequent Alarm Operation	51
8.5 Auto-Scroll LCD Keypad Display	51
8.6 Fire Trouble Conditions	51
8.7 AC Delays	52
8.8 Fire Reporting Codes	52

Section 9: Listing Requirements	54
9.1 UL Listed Commercial and Residential Installations	54
9.2 Commercial Fire Monitoring Installations	54
9.3 ULC Listing Requirements	54

Appendix A: Reporting Codes	55
------------------------------------	-----------

Appendix B: Wiring Diagrams	58
------------------------------------	-----------

PC5020 UL Wiring Diagram

Household Fire / Burglary / Home Health Care / Commercial Burglary

- SIA-FAR Minimum System Requirements:**
- 1 PC5020 Control Panel
 - 2 Local announcement devices
- Local announcement devices may be any combination of these keypads:
- LCD5500Z • PKP-LCD
 - LCD5501Z • PKP-ICON

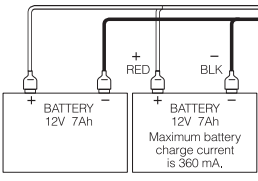

Battery capacity for standby is at least 24 hours. Recommended battery: DSC model BD7-12.

**Min./Max operating voltage for devices/sensors/modules is 10.2VDC -14VDC

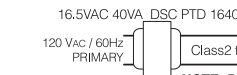

NOTE: A ux+ (420mA) is shared between Aux+, Keybus and all PGM outputs.



WARNING Incorrect connections may result in PTC failure or improper operation. Inspect wiring and ensure connections are correct before applying power.

WARNING High voltage. Disconnect AC power & telephone lines prior to servicing.

PC-Link Connection

All circuits are classified for UL installations as power limited/Class II power limited, except for the battery leads which are not power limited. Do not route any wiring over circuit boards. Maintain at least 1" (25.4mm) separation. Please see Section 2. A minimum 1/4" (6.4mm) separation must be maintained at all points between power limited wiring and all other non-power limited wiring.



- APPLICABLE UL STANDARDS**
- UL FILE NO. #4019**
- UL1610 Central-Station Burglar Alarm Units
 - UL1609 Local Burglar Alarm Units and Systems
 - UL365 Police Station Connected Burglar Alarm Units & Systems
 - UL985 Household Fire Warning System Units
 - UL1023 Household Burglar Alarm System Units
 - UL1635 Digital Alarm Communicator System Units
 - UL1637 Home Health Care Signaling Equipment ANSISIA CP-01-2000

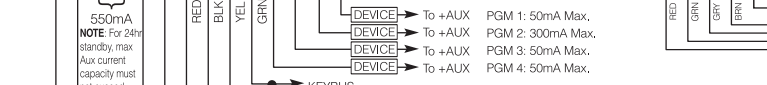
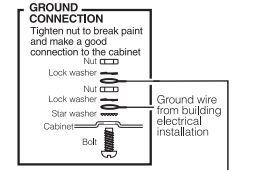

2-WIRE SMOKE DETECTORS

Compatibility Identifier: PC5-2
 Maximum Operating Voltage: 13.9 Vdc
 Maximum Circuit Resistance: 100Ω (total)
Do not mix different models on the same circuit as correct operation may be impaired.

Name	Model	Compatibility ID	Max #	Base
DSC	MN220, -R, -T, -RT	PS-220	30	None
System Sensor	2100TR or 2100AT	A	30	None
Sentrol	429AT or 521B/BXT 400 series, 429C, 429CT 429CST, 429CRT, 429CSST 521CRKT 521B, 521BXT 711U/UT, 712U, 721U/UD/UT 713-SU, 713-6U, 722U 731U, 731UD, 732U	S09A S10A S11A S11A S10A S10A S10A S10A S11A	30 30 30 30 30 30 30 30 30	None None None None None None None None None

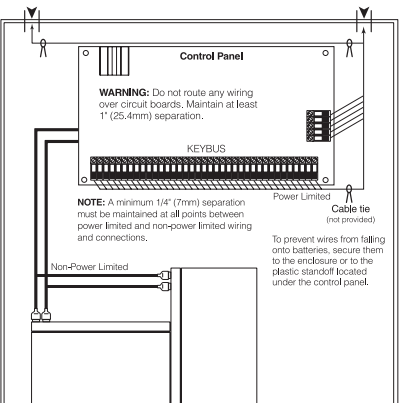

PGM CONNECTIONS

TYPICAL ZONE CIRCUITS

RESISTOR IDENTIFICATIONS

- 2-WIRE SMOKE**: 2200Ω 5% (RED, RED, RED, GOLD)
- BELL CIRCUIT**: 1000Ω 5% (BRN, BLK, RED, GOLD)
- SINGLE ZONE EOL**: 5600Ω 5% (GRN, BLUE, RED, GOLD)

4-WIRE SMOKE DETECTORS

Smoke detector must be latching type (such as DSC MN240 Series). To reset smoke detectors, enter [*] [7] [2].

INSTALL BATTERY AND AC WIRING AS SHOWN
IMPORTANT: A minimum of 1/4" (6.4mm) separation must be maintained at all points between power limited wiring and connections. Wire entry for power limited wiring must be separate from non-power limited wiring.

WARNING: Not to be removed by anyone except occupant. This equipment should be installed in accordance with the National Fire Code ANSI/NFPA 72 (National Fire Protection Association, Batterymarch Park, Quincy MA, 02269). Printed information describing proper installation, operation, testing, maintenance, evacuation planning, and repair service is to be provided with this equipment. For compliance with UL-985, at least one hardwired smoke detector is required.

This device complies with Parts 15 and 68 of the FCC rules. Operation is subject to the following two conditions: (1) this device may not cause harmful interference, and (2) this device must accept any interference received, including interference that may cause undesired operation.
 FCC Reg. No.: F53CAN-34330-AL-E REN = 0.1B Plug Type: RJ-31X MADE IN CANADA

(a) The delay (power-up) (start-up) time marked on the installation wiring diagram of the smoke detector or on the installed smoke detector(s) is to be used.

Temperature Range: 0°C-49°C (32°F-120°F)
 Maximum Humidity: 85% RH
 Refer to the *Installation Manual* #29005907 & *Instruction Manual* #29005909 for complete operating instructions. The PC5020 is UL Listed for limited energy installations per NEC Article 760. Recognized limited energy cable should be used. Observe NEC wiring requirements and local codes defined by the authority having jurisdiction. Security detection devices that require power from the control panel must be UL Listed for the intended application and operate over the range of 11.6-12.6 VDC (residential), 12.0 VDC (commercial). The DSC Bravo Series are recommended UL Listed motion detectors. Compatible system keypads: PC5502Z, PC5508Z/KP5508Z, PC5516Z/KP5516Z, PC5532Z/KP5532Z, LCD5500Z/KPL5500Z, LCD5501Z/KPL5501Z, LCD5501Z32-900/PICON-900, LKP-LCD, LKP-ICON, LCD5501Z32-433.

Circuit (zone)	Control Unit Delay - Sec.	Smoke Detector	
		Model	Delay - Sec. (a)

- Control panel is suitable for the following UL installations:
- Grade AA Central Station and Grade AA Police Connect with high line security (using T-Link to communicate to Sur-Gard MLR-IP receiver)
 - Household Fire and Grade A Household Burglary and Home Health Care Signaling Equipment
 - Grade A Local I Grade B Central Station and Police Connect with basic line security
 - Grade C Central Station
 - Refer to Installation Manuals

NOTE: For ULC installations please refer to the ULC Wiring Diagram part #18006238 and the ULC Installation Information Sheet part #29002157.

Section 1: Introduction

1.1 About the PC5020 System

The PC5020 is a high end security system. It supports up to 64 zones, 8 separate partitions, and 32 users.

The user interface is simple and easy to use. The LCD5500Z keypad guides users through their available options with easy-to-understand prompts.

The status of the PC5020 system can be monitored over telephone lines, or using an alternative communicating device, including LINKS1000, LINKS2X50, LINKS3000, Skyroute™ and DVACS*.

The PC5020 main board comes with 4 programmable outputs, and you can add up to 12 more using PC5204 and PC5208 modules. You can program the outputs to control things such as doorstrikes and lights, using 25 different output options. See 'Programmable Outputs' in Section 5. You can program the PC5020 using any system keypad, or using DLS-3 downloading software and a computer. See 'How to Program' on page 10.

Review the complete PC5020 manual set before installing the PC5020 security system

1.2 About the PC5020 Manual Set Installer Manuals

Read the entire manual carefully before beginning your installation.

This manual describes:

- An overview of the system (Section 1: 'Introduction')
- How to install and wire the system and its modules (Section 2: 'Installation and Wiring')
- How to program the system (Section 3: 'How to Program')
- An introduction to the user interface and keypad operation (Section 4: 'Keypad Commands')
- An overview of the main system programming sections (Section 5: 'Programming Sections').

Be sure to record all your system programming in the **Programming Worksheets**.

If you will be adding modules to your PC5020 system, read the **Installation Instructions** that come with each module.

User's Guide

One User's Guide comes with the PC5020 system. The **User's Guide** provides easy to follow instructions for end-users. Installers should also review this manual, in order to properly instruct the end-users once the installation is complete.

Commercial Fire Application

Please refer to the *Central and Remote Station Fire Installation Guide* for information concerning Commercial Fire applications.

1.3 Main Panel Specifications

Flexible Zone Configuration:

- 8 fully programmable zones
- 39 access codes: 32 user, 1 system master, 2 supervisor codes, 2 duress, 1 maintenance and 1 installer code
- Expandable to 64 zones
- Keypads with zone inputs available (PC5508Z, PC5516Z, PC5532Z, LCD5500Z, and LCD5501Z)
- Hardwired expansion available using the PC5108 8-zone expansion module, the PC5100 addressable 32 zone expansion module and the PC5700/5720 fire module

- Wireless expansion available using the PC5132 wireless 32 zone expansion module (433 or 900MHz, fully supervised)
- Normally closed, Single EOL, or Double EOL zone supervision
- 34 zone types, 8 programmable zone options
- Up to 8 partitions

Audible Alarm Output:

- 700mA supervised bell output (current limit 3 Amps), 12 VDC
- Steady or pulsed output

EEPROM Memory:

- Will not lose programming or system status on complete AC and battery failure

Programmable Outputs:

- Up to 14 programmable outputs, 21 programmable options
- Three low current (50 mA) PGM outputs on main panel (PGM1, PGM3, PGM4)
- One high current (300 mA) PGM output with 2-wire smoke detector capability on main panel (PGM 2)
- Eight additional low current (50 mA) PGM outputs available using the PC5208 module
- Four high current (1 Amp) PGM outputs available using the PC5204 module (1 PC5204 output, fully supervised for siren output)

Powerful 1.5 Amp Regulated Power Supply:

- 550 mA auxiliary supply, 12 VDC
- Positive temperature coefficient (PTC) components replace fuses
- Supervision for loss of AC power, low battery
- Internal clock locked to AC power frequency

NOTE: For 24-hr standby, maximum Aux capacity is 420mA.

Power Requirements:

- Transformer = 16.0 VAC, 40VA (min) permanently connected
- Battery = (2) 12 volt 7Ah (min.) rechargeable sealed lead acid or (1) 12 volt 4Ah battery (for Burglary applications only)
- PC5020 current draw: 65mA

Remote Keypad Specifications:

- Various keypads are available:
 - PC5508Z 8 Zone LED keypad
 - PC5516Z 16 Zone LED keypad
 - PC5532Z 32 Zone LED keypad
 - LCD5500Z Liquid Crystal Display keypad
 - LCD5501Z LCD-style keypad
 - LCD5501Z32-900/LCD5501Z32-433 keypad/receiver
- 'Z' version keypads have one zone input
- Each keypad has 5 fully programmable function keys
- Connect up to 8 keypads
- Four wire (Quad) connection to Keybus
- Built in piezoelectric buzzer

Digital Communicator Specifications:

- Supports all major formats including SIA, Contact ID, and Residential Dial
- Split reporting of selected transmissions to each telephone number
- 3 programmable telephone numbers

- 1 system account number, plus 8 partition account numbers
- Supports LINKS1000, GSM1000 cellular communication, Links 2X50 long range alarm transmitter and Skyroute™ Cellemetry communication transceiver
- DTMF and pulse dialing
- DPDT line seizure
- Anti-jam detection
- Event-initiated personal paging
- T-Link communications via PC-Link (see T-Link Installation Manual part no. 29001007)

System Supervision Features

The PC5020 continuously monitors a number of possible Trouble conditions including:

- AC power failure
- Trouble by zone
- Fire trouble
- Telephone line trouble
- Low battery condition
- Bell output trouble
- Loss of internal clock
- AUX power supply fault
- Tamper by zone
- Failure to communicate
- Module Fault (Supervisory or Tamper)
- Camera Troubles via DLM-4L

False Alarm Prevention Features

- Audible Exit Delay
- Audible Exit Fault
- Urgency on Entry Delay
- Quick Exit
- Swinger Shutdown
- Recent Closing Transmission
- Cross Zone Alarm
- Burglary-verified timer
- Double Hit Timer
- Communication Delay
- Rotating Keypress Buffer

Additional Features

- Automatic arming by partition at a specified time, each day of the week
- Keypad-activated alarm output and communicator test
- Keypad lockout
- Audio capability using the PC5936 audio interface module; allows local intercom and central station 2-way listen-in
- All modules connect to the system via a four wire Keypbus, up to 1000' / 305m from the main panel
- Event buffer can be printed using PC5400 RS-232 serial interface module
- Supports the Escort5580(TC) Voice Prompt Module, with automation and lighting control
- 256-event buffer, time and date stamped
- Uploading/downloading capability
- Daylight Savings Time option
- Downlook support (DLM-4L v1.0 and PC5108L)

1.4 Additional Devices

In addition to the information below, see the back cover for a DSC Module Compatibility table.

Keypads

A maximum of 8 keypads can be connected to the control panel. You can connect any combination of the following listed. Different keypads (with function keys) can be used for different size systems: 8 zone, 16 zone, 32 zone, & 64 zone.

- PC5508Z: 8 zone LED keypad, with one zone input
- PC5516Z: 16 zone LED keypad, with one zone input
- PC5532Z: 32 zone LED keypad, with one zone input
- LCD5500Z: LCD keypad, with one zone input
- LCD5501Z: LCD-style keypad, with one zone input
- LCD5501Z32-433: keypad/receiver

NOTE: The following keypad versions can only be used on the first two partitions (partition 1 and partition 2), and the first 8, 16, or 32 zones: PC5508(Z), PC5516(Z), PC5532(Z) v2.00 and lower, LCD5500(Z) versions 2.x and lower, LCD5501Z versions 1.x and lower

PC5100 2-Wire Addressable Device Interface Module

The PC5100 module is used to connect 2-wire addressable devices to the system. Up to 32 2-wire addressable devices can be added to the system.

NOTE: PC5100 v1.0 and lower modules can only support the first 32 zones on the PC5020 system.

PC5108 Eight Zone Expander Module

Eight zone expander module can be used to increase the number of zones on the system. Up to 7 modules can be connected to increase the system zones to a maximum of 64 (see the PC5108 Installation Instructions Sheet).

NOTE: PC5108 v1.0 and lower modules can only support the first 32 zones on the PC5020 system. PC5108 v1.0 and lower modules enroll as two modules and use up two supervisory slots.

NOTE: Do not mix PC5108 v1.x and lower modules with PC5108 v2.0 and higher modules on the same system.

PC5132 Wireless Receiver Module

The PC5132 wireless receiver module can be used to connect up to 32 fully supervised wireless devices (see the PC5132 Installation Manual for details.)

NOTE: Only the first 32 zones on the PC5020 system can be used as wireless zones.

PC5200 Power Supply Output Module

The PC5200 can provide up to 1 Amp of additional power for modules or devices connected to the control panel. Up to 4 modules can be connected to the system. Each module requires a 16.5 volt AC 40 VA transformer and 4Ah battery (see PC5200 Installation Instructions for details).

PC5204 Power Supply Output Module

The PC5204 can provide up to 1 Amp of additional power for modules or devices connected to the control panel. The module requires a 16.5 volt AC 40 VA transformer and 4 Ah battery. In addition, the module provides 4 programmable high current voltage outputs. (See PC5204 Installation Instructions for details).

PC5208 Eight Low Current Output Module

Adds 8 programmable low current outputs (50mA) to the control (see the PC5208 Installation Instructions for details).

NOTE: If you use the main panel and the PC5208 outputs, PGM 3 will work the same as the first PC5208 output, and PGM 4 will work the same as the second PC5208 output.

Escort5580(TC) Module

This Escort5580(TC) module will turn any tone telephone into a fully functional keypad. The module also includes a built-in interface to control up to 32 line carrier type devices for lighting and temperature control (see the Escort5580(TC) Installation Manual for details.)

NOTE: Users will not be able to access partitions 3 to 8, and zones 33 to 64 through Escort5580(TC) versions 2.x and lower. Only partitions 1 and 2, and zones 1 to 32 are supported on these versions.

PC5936 Audio Interface Module

The PC5936 audio interface module provides paging, intercom, baby listen-in and door answer to the PC5020 control panel. The module has built-in two-way voice capability for central station (see the *PC5936 Installation Manual for details*).

Three additional devices are available:

- PC5921 PKP-ICM Intercom Audio Station can be used in conjunction with the PC5936 Audio Interface Module.
- PC5921 EXT Door Box Audio Station can be used in conjunction with the PC5936 Audio Interface Module.
- PC5921 EXT/R Door Box Audio Station can be used in conjunction with the PC5936 Audio Interface Module. The Door Box contains a relay so the normal door bell can be used instead of the internal one generated by the PC5936 Audio Interface Modules.

PC5400 Printer Module

This PC5400 printer module will allow the panel to print out all events that occur on the system to any serial printer. All events will be printed with the partition, time, date and the event that occurred (see *PC5400 Installation Manual for details*).

NOTE: The PC5400 v2.x and lower only supports events on partitions 1 and 2, and zones 1-32.

LINKS1000 Cellular Communicator

The LINKS1000 Cellular Communicator provides an efficient, cost-effective method for adding cellular back-up. The unit comes in its own cabinet with antenna and requires a separate battery and transformer (see *Links1000 Cellular Communicator in Section 5*).

T-Link Local Area Network Communicator

The T-Link Local Area Network Communicator provides an efficient method of communicating via a Local Area Network (LAN). See the T-Link *Installation Manual* for more details.

Alternate Communicators

Refer to the associated *Installation Manual* for LINKS2X50, LINKS3000, & Skyroute™ programming details.

Downlook Support: PC5108L and DLM-4 v1.0L

The PC5108L will expand the control panel's zone capability by adding eight fully programmable zone inputs. The module will also act as an interface between the DLM-4L v1.0 video transmission module and the PC5020 control panel. The PC5108L is also an 8-camera video switcher.

For more information on either module, see their respective *Installation Manuals*.

NOTE: The PC5108L module can only be assigned zones from 9 to 32. The PC5108L will not support zones 33 to 64. Camera scripts can only be run for zones 1 to 32. The PC5108L enrolls as two expander modules and use up two supervisory slots.

NOTE: Do not mix PC5108L v1.x and lower modules with PC5108 v2.0 and higher modules on the same system.

PC5700 Fire Module

This is a zone expansion module with four general purpose zone inputs, two Class A supervisory waterflow zone inputs, ground fault detection and dual-supervised telephone line inputs.

PC5720 Fire Module

This is a zone expansion fire module that can be used for ULC Listed non-residential fire applications. The PC5720 can also be used as an interface between the control panel and either a serial printer or a DVACS communications network.

NOTE: The PC5700 v1.x and PC5720 v1.x enroll as two expander modules and use two supervisory slots.

NOTE: Do not mix PC5700 v1.x and PC5720 v1.x and lower modules with PC5108 v2.0 and higher modules on the same system.

Cabinets

Several different cabinets are available for the PC5020 modules. They are as follows:

- **PC4050C** - alternate main control cabinet (Household Fire & Burglary) for the PC5020 main panel. Dimensions 305mm x 376mm x 125mm / 12.0" x 14.8" x 4.9" approximately.
- **PC4050CR** - alternate main control cabinet (Commercial Fire) for the PC5020 main panel. Dimensions 305mm x 376mm x 125mm / 12.0" x 14.8" x 4.9" approximately.
- **PC4050CAR** - alternate main control cabinet (Commercial Burglary) for the PC5020 main panel. Dimensions 305mm x 376mm x 125mm / 12.0" x 14.8" x 4.9" approximately.
- **PC4050CRAR** - alternate main control cabinet (Commercial Fire and Commercial Burglary) for the PC5020 main panel. Dimensions 305mm x 376mm x 125mm / 12.0" x 14.8" x 4.9" approximately.
- **PC500C** - alternate main control cabinet (Household Burglary). Dimensions 213mm x 235mm x 78mm / 8.4" x 9.25" x 3" approximately.
- **PC5002C** - cabinet to house the PC5204 power supply output module. Dimensions 213mm x 235mm x 78mm / 8.4" x 9.25" x 3" approximately.
- **PC5003C** - main control cabinet for the PC5020 main panel. Dimensions 222mm x 298mm x 78mm / 11.3" x 11.7" x 3.0" approximately (Household Fire & Burglary).
- **PC5004C** - cabinet to house the Escort5580(TC) module and PC5400 Printer Module. Dimensions 229mm x 178mm x 65mm / 9" x 7" x 2.6" approximately.
- **PC5001C** - cabinet to house the PC5108 zone expander module and the PC5208 8 low current output module. Dimensions 153mm x 122mm x 38mm / 6" x 4.8" x 1.5" approximately.
- **PC5001CP** - plastic cabinet to house the PC5108 zone expander module and the PC5208 8 low current output module. Dimensions 146mm x 105mm x 25.5mm / 5.75" x 4.2" x 1" approximately.
- **CMC-1** - alternate main control cabinet (Commercial Burglary) Dimensions 222mm x 298mm x 78mm / 11.3" x 11.7" x 3.0" approximately.
- **Multi-3** - cabinet to house the PC5936/PC5937 modules. Dimensions 287mm x 298mm x 78mm / 11.3" x 11.7" x 3.0" approximately.
- **HS-CAB100** - structured wiring cabinet for PC5020 main panel. Dimensions 362mm x 229mm x 102mm / 14.25" x 9" x 4" with a wire raceway positioned on the right side of the cabinet. The cover is 389mm x 254mm / 15.3" x 10".
- **HS-CAB200** - structured wiring cabinet for PC5020 main panel. Dimensions are 362mm x 362mm x 102mm / 14.25" x 14.25" x 4" with a wire raceway in the center of the cabinet. The cover is 389mm x 389mm / 15.3" x 15.3".
- **HS-CAB2800** - structured wiring cabinet for PC5020 main panel. Dimensions 724mm x 362mm x 102mm / 28.5" x 14.25" x 4" with a wire raceway in the center of the cabinet. The cover is 752mm x 387mm / 29.6" x 15.3".
- **HS-CAB4200** - structured wiring cabinet for PC5020 main panel. Dimensions 1086mm x 362mm x 102mm / 42.75" x 14.25" x 4.0" with a wire raceway in the center of the cabinet.

Backplates

There are two different backplates available for keypads to mount an audio station next to a keypad:

PC55BP1 Backplate

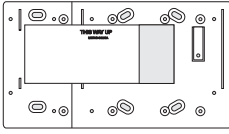

Use this backplate when mounting an audio station next to a keypad. Dimensions 208mm x 115mm x 18mm / 8.2" x 4.5" x 0.25" approximately.

PC55BP2 Backplate

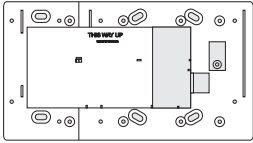

Use this backplate when mounting an audio station next to a keypad. In addition the backplate will allow you to mount a PC5108 zone expander module or the PC5208 8 low current output module. Dimensions 208mm x 115mm x 18mm / 8.2" x 4.5" x 0.7" approximately.

Section 2: Installation and Wiring

The following sections provide a complete description of how to wire and configure devices and zones.

2.1 Installation Steps

The following steps are provided to assist with the installation of the panel. It is suggested that you read over this section briefly to get an overall understanding of the order of installation. Once this is done carefully work through each step. Working from this plan will help reduce problems and reduce the overall installation time required.

Step 1 Create a Layout

Draw a rough sketch of the building and include all alarm detection devices, zone expanders, keypads and all other modules that are required.

Step 2 Mounting the Panel

Locate the panel in a dry area, preferably located near an unswitched AC power source and the incoming telephone line. Before attaching the cabinet to the wall be sure to press the five circuit board mounting studs into the cabinet from the back.

NOTE: Complete all wiring before applying AC or connecting the battery.

Step 3 Wiring the Keybus (Section 2.4)

Wire the Keybus to each of the modules following the guidelines provided.

Step 4 Assigning Zones to Zone Expanders (Section 2.6)

If zone expander modules are being used the modules must be configured so the panel knows which zones are assigned to each expander. Follow the guideline provided to assign zones to expanders.

Step 5 Zone Wiring (Section 2.10)

Power down the control panel and complete all zone wiring. Follow the guidelines provided in section 2.10 to connect zones using normally closed loops, single EOL resistor, double EOL resistors, Fire zones and Keyswitch Arming zones.

Step 6 Completing Wiring

Complete all other wiring including bells or sirens, telephone line connections, ground connections or any other wiring necessary. Follow the guidelines provided in section 2.2 'Terminal Descriptions'.

Step 7 Power up the Control Panel

Once all zone wiring and Keybus wiring is complete, power up the control panel.

NOTE: The panel will not power up if only the battery is connected.

Step 8 Keypad Assignment (Section 2.7)

Keypads must be assigned to different slots to be properly supervised. Follow the guideline provided in section 2.7 to assign keypads.

Step 9 Confirming Module Supervision (Section 2.8)

By default, all modules are supervised upon installation. Supervision is enabled at all times so that the panel can indicate a Trouble if a module is removed from the system.

To confirm that each module is properly supervised, follow the guidelines provided in section 2.8.

Step 10 Programming the System (Sections 4 & 5)

Section 4.0 provides a complete description of how to program the panel. Section 5.0 contains complete descriptions of the various programmable features, what options are available and how the options function. The *Programming Worksheets* should be filled out completely before attempting to program the system.

Step 11 Testing the System

Test the panel completely to ensure that all features and functions are operating as programmed.

2.2 Terminal Descriptions

AC Terminals

The panel requires a 16.5 volt, 40 VA transformer. Connect the transformer to an unswitched AC source and connect the transformer to these terminals.

NOTE: Do not connect the transformer until all other wiring is complete.

Battery Connection

The battery is used to provide backup power in the event of an AC power failure and to provide additional current when the panel demands exceed the power output of the transformer, such as when the panel is in alarm.

NOTE: Do not connect the battery until all other wiring is complete.

Connect the RED battery lead to the positive of the battery, the BLACK battery lead to the negative.

Auxiliary Power Terminals - AUX+ and GND

These terminals provide up to 550mA of current at 12 VDC (rated 11.6-12.6 Vdc for UL residential applications) for devices requiring power. Connect the positive side of any device requiring power to the AUX+ terminal, the negative side to GND. The AUX output is protected; if too much current is drawn from these terminals (wiring short) the panel will temporarily shut off the output, until the problem is corrected. **NOTE:** The maximum AUX capacity for 24-hr standby is 420mA.

Bell Output Terminals - BELL+ and BELL-

These terminals provide up to 3 Amps of current at 12 VDC (with standby battery; 700 mA continuous) for powering bells, sirens, strobes or other warning type equipment. Connect the positive side of any alarm warning device to BELL+, the negative side to BELL-. The BELL output is protected; if too much current is drawn from these terminals (wiring short) the BELL PTC will open.

The bell output is supervised. If no alarm warning device is being used connect a 1K Ω resistor across BELL+ and BELL- to prevent the panel from displaying a Trouble condition (see section '[*][2] Trouble Display').

Keybus Terminals - RED, BLK, YEL, GRN

The Keybus is used by the panel to communicate with modules and by modules to communicate with the panel. Each module has four Keybus terminals that must be connected to the four Keybus terminals on the panel. For more information, see section 'Keybus Operation and Wiring'.

Programmable Outputs PGM1, PGM2, PGM3, PGM4

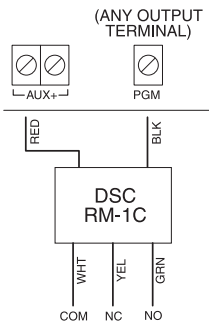

Each PGM output is designed so that when activated by the panel, the terminal will switch to ground. PGM1, PGM3, and PGM4 can each sink up to 50 mA of current. These PGMs can be used to activate LEDs or a small buzzer. Connect the positive side of the LED or buzzer to AUX+, the negative side to the PGM.

PGM2 is a high current output (300mA) and operates similarly to PGM1. If more than 300 mA of current is required, a relay must be used.

PGM2 can be used for 2-wire smoke detectors with Jumper CON1 removed, otherwise, CON1 must remain on at all times (see section 2.10 'Zone Wiring').

Zone Input Terminals - Z1 to Z8

Each detection device must be connected to a zone on the control panel. It is suggested that each zone have one detection device however it is possible to wire multiple detection devices to the same zone.

For zone wiring specifics, see section 'Zone Wiring'.

Telephone Connection Terminals - TIP, RING, T-1, R-1

If a telephone line is required for central station communication or downloading, connect an RJ-31X jack in the following manner:

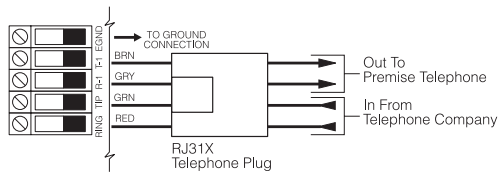

Connect the PC5020 and modules that use the telephone line(s) in the following order:

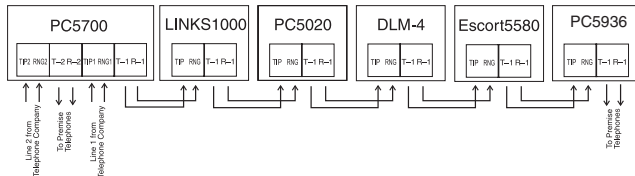

For example, if you are installing a PC5020 with a LINKS1000/GSM1000 and a PC5936 intercom module, connect the incoming line to the LINKS1000, then from the LINKS1000 to the PC5020, then from the PC5020 to the PC5936 audio module and then from the PC5936 module to the house telephones.

NOTE: Ensure that all plugs and jacks meet the dimension, tolerance and metallic plating requirements of 47 C.F.R. Part 68, SubPart F. For proper operation there must be no other telephone equipment connected between the control panel and the telephone company facilities.

NOTE: Do not connect the alarm panel communicator to telephone lines intended for use with a FAX machine. These lines may incorporate a voice filter which disconnects the line if anything other than FAX signals are detected, resulting in incomplete transmissions.

2.3 Wire Routing for Power & Non-Power Limited

All wiring entry points are designated by the arrows. All circuits are classified UL installation power limited except for the battery leads which are not power limited.

A minimum 1/4" (6.4mm) separation must be maintained at all points between power limited and non-power limited wiring and connections.

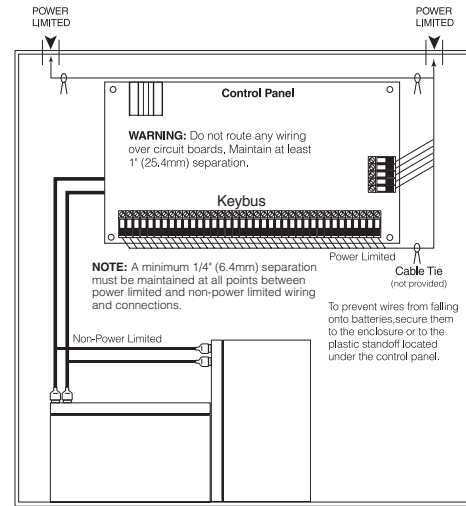

NOTE: Wire entry for power limited wiring must be separated by a different entry access from non-power limited wiring.

2.4 Keybus Operation and Wiring

The Keybus is used by the panel to communicate with all modules connected and by the modules to talk to the panel. The RED and BLK terminals are used to provide power while YEL and GRN are clock and data.

NOTE: The 4 Keybus terminals of the panel must be connected to the 4 Keybus terminals or wires of all modules.

The following conditions apply:

- Keybus should be run in minimum 22 gauge quad (0.5mm), two pair twisted preferred
- the modules can be home-run to the panel, connected in series or can be T-tapped
- any module can be connected anywhere along the Keybus; you do not need a separate Keybus wire run for keypads, zone expanders etc.
- no module can be more than 1,000'/305m (in wire length) from the panel
- shielded wire is not necessary unless wires are run in an area that may present excessive RF noise or interference

Example of Keybus Wiring

Module (A) is wired correctly as it is within 1,000'/305m of the panel, in wire distance. Module (B) is wired correctly as it is within 1,000'/305m of the panel, in wire distance. Module (C) is NOT wired correctly as it is further than 1,000'/305m from the panel, in wire distance.

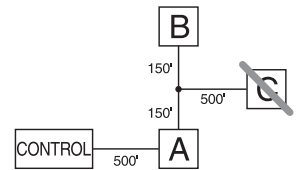

2.5 Current Ratings - Modules & Accessories

In order for the PC5020 system to operate properly, the power output capabilities of the main control and expansion devices must not be exceeded. Use the data presented below to ensure that no part of the system is overloaded and cannot function properly.

PC5020 Device Ratings (@ 12 Vdc)

- LCD5500Z Keypad: 85 mA
- LCD5501Z Keypad: 45mA
- LCD5501Z32-433 Keypad/Receiver: 260mA (max.)

- PC5100 Addressable Device Interface Module: 40mA
- PC5508Z Keypad: 80 mA
- PC5516Z Keypad: 90 mA
- PC5532Z Keypad: 120 mA
- PC5108 Zone Module: 35 mA
- PC5108L Downlook Interface: 60 mA
- PC5132 Wireless Module: 125 mA
- PC5200 Output Module: 20 mA
- PC5204 Output Module: 20 mA
- PC5208 Output Module: 50 mA
- PC5320 Multiple Receiver Interface Module: 55mA
- Escort5580(TC) Module: 150 mA
- PC5400 Printer Module: 65 mA
- PC5700 Fire Module: 150 mA
- PC5904 Central Station Talk/Listen Module: 175mA
- PC5936 Audio Interface Module: 65 mA
- PC5937 Audio Port Expansion Module: 5mA
- PC5921 Intercom Audio Station: 20 mA
- PC5921 EXT Door Box Audio Station: 20 mA
- PC5921 EXT/R Door Box Audio Station: 35 mA
- DLM-4L v1.0: 180 mA
- T-Link module: 150mA

System Outputs (all 12 Vdc)

PC5020	VAUX:	550 mA. Subtract the listed rating for each keypad, expansion module and accessory connected to VAUX or Keybus. NOTE: The maximum AUX capacity for 24-hr standby is 420mA.
	BELL:	700 mA. Continuous Rating. 3.0 A. Short Term. Available only with standby battery connected.
PC5200	VAUX:	1.0 A. Continuous Rating. Subtract for each device connected. 3.0 A. Short Term. Available only with standby battery connected.
	VAUX:	1.0 A. Continuous Rating. Subtract for each device connected. 3.0 A. Short Term. Available only with standby battery connected.
PC5204	VAUX:	1.0 A. Continuous Rating. Subtract for each device connected. 3.0 A. Short Term. Available only with standby battery connected.
	VAUX:	250 mA. Subtract for each device connected. Subtract the total load on this terminal from the PC5020 VAUX/Keybus output.
PC5108	VAUX:	100 mA. Subtract for each device connected. Subtract the total load on this terminal from the PC5020 VAUX/Keybus output.

Other Devices

Read the manufacturer’s literature carefully to determine the maximum current requirement (during activation or alarm) and use this value for loading calculations. Do not allow connected devices to exceed the system capabilities during any possible operational mode.

2.6 Assigning Zones to Zone Expanders

The main panel contains zones 1 to 8. Additional zone expanders may be added to increase the number of zones on the system. Each zone expander consists of one group of 8 zones. Each module must be set to assign the specific zones to the expander. To do this, set the jumpers located on the expander to the proper settings (see chart below).

NOTE: PC5108 v1.0 and lower modules can only support the first 32 zones on the PC5020 system. PC5108 v1.0 and lower, PC5108L, PC5700, and PC5720 each enroll as two expander modules.

NOTE: Before a zone expander will work properly, you must set the jumpers so the panel can determine the correct zone assignment.

NOTE: It is not recommended to use PC5108 v1.x and v2.x simultaneously on the same PC5020.

The following are the jumper settings for different zone assignments for PC5108 v2.0 modules. If you need to enroll PC5108 v1.0, PC5108L or PC5700 modules, refer to the appropriate module *Installation Sheet* for the correct jumper settings.

Module Jumpers			System Zones Assigned
J1	J2	J3	
ON	ON	ON	Zones disabled
OFF	ON	ON	Zones 09 - 16
ON	OFF	ON	Zones 17 - 24
OFF	OFF	ON	Zones 25 - 32
ON	ON	OFF	Zones 33 - 40
OFF	ON	OFF	Zones 41 - 48
ON	OFF	OFF	Zones 49 - 56
OFF	OFF	OFF	Zones 57 - 64

The following is a diagram of the PC5108 zone expander modules and where the jumper switches are located. Refer to the *Installation Instructions* for the module for more information.

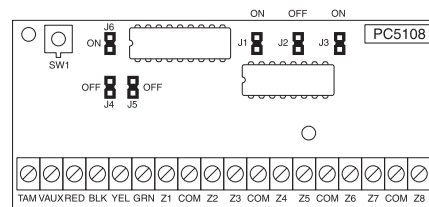

NOTE: Only jumpers J1, J2, and J3 determine the zone assignment for the module.

2.7 Keypad Assignment

There are 8 available slots for keypads. LED and LCD5501Z keypads by default are assigned to slot 1. The LCD5500Z is assigned by default to slot 8. Keypads can each be assigned to a different slot (1 to 8) which offers two advantages. The panel can supervise the keypad connection to indicate a Trouble condition if it is removed. Also keypads can be assigned to operate a specific partition, or to operate as a global keypad.

How to Assign Keypads

NOTE: All keypad assignment must be done at each keypad on the system. When using LCD5500(Z) keypads, one keypad must remain in slot 8. Do not assign more than one keypad to the same slot.

NOTE: The following keypad versions can only be used on partition 1 & partition 2, and the first 8, 16, or 32 zones: PC5508(Z), PC5516(Z), PC5532(Z) versions v2.0 & lower, LCD5500(Z) versions 3.x and lower. To assign a keypad to a slot and select the partition it will operate, enter the following:

1. Enter Installer Programming
2. Press [000] for Keypad Programming
3. Press [0] for Partition and Slot Assignment
4. Enter a two digit number to specify the partition and slot assignment.
 - 1st digit enter 0 for Global operation, or enter 1-8 for partitions 1-8
 - 2nd digit enter 1 to 8 for Slot Assignment
5. Press the [#] key twice to exit programming.

- Continue this procedure at each keypad until all have been assigned to the correct slot and partition.

How to Program Function Keys

Each of the 5 function keys on each keypad may be programmed for different operation.

- Enter Installer Programming.
- Press [000] for Keypad Programming.
- Enter [1] to [5] to select function key to program.
- Enter a 2-digit number for function key option - [00] to [30].
- Continue from step 3 until all function keys are programmed.
- Press [#] key twice to exit Installer Programming.

For a complete list of Function Key options, see section 'Function Keys'.

2.8 Confirming Module Supervision

By default, all modules are supervised upon installation. Supervision is enabled at all times so that the panel can indicate a trouble if a module is removed from the system. To check which modules are currently connected and supervised:

- Press [*] [8] [Installer Code] to enter Installer Programming.
- Press [903] to display all modules.
- The LCD keypad will allow you to scroll through the modules.

NOTE: Module supervision will not display correctly at an LCD5500Z v2.x and lower keypad.

In LED keypads, zone lights will be turned on according to what modules the panel has found on the system.

Refer to the following chart:

Keypad Light	Module/Device Present
[1]	Keypad 1
[2]	Keypad 2
[3]	Keypad 3
[4]	Keypad 4
[5]	Keypad 5
[6]	Keypad 6
[7]	Keypad 7
[8]	Keypad 8
[9]	Zones 9 to 16
[10]	Zones 17 to 24
[11]	Zones 25 to 32
[12]	Zones 33 to 40
[13]	Zones 41 to 48
[14]	Zones 49 to 56
[15]	PC5100
[16]	Zones 57 to 64
[17]	PC5132
[18]	PC5208
[19]	PC5204
[20]	PC5400
[21]	PC5936
[22]	LINKS2X50/Skyroute™
[23]	DLM-4L v1.0
[24]	Escort5580(TC)
[25]	Future Use
[26]	PC520X-1
[27]	PC520X-2
[28]	PC520X-3
[29]	PC520X-4

If a module is connected but does not show as being present, it may be due to any of the following reasons:

- it is not connected to the Keybus
- there is a Keybus wiring problem
- the module is more than 1,000'/305m from the panel
- the module does not have enough power
- the PC5132 does not have any devices added

2.9 Removing Modules

If a module is no longer required on the system, the panel must be told to stop supervising the module. To do this:

- Remove the module from the Keybus.
- Press [*] [8] [Installer Code] to enter Installer Programming.
- Press [902] to enable supervision. The panel will automatically search for all modules on the system, will see that the module has been removed, and will stop supervising it.
- Once the search is complete (it will take about 1 minute) enter section [903] to confirm that the correct modules are supervised on the system.

2.10 Zone Wiring

For a complete description of the operation of all zone types, see section 'Basic Programming PWS Sect 3'.

There are several different ways in which zones may be wired, depending on which programming options have been selected. The panel can be programmed to supervise normally closed, end of line, or double end of line loops. Refer to the following sections to study each type of individually supervised zone wiring.

NOTE: Any zone programmed for Fire or 24-hr Supervisory must be wired with a single end of line (EOL) resistor regardless of the type of zone wiring supervision selected for the panel (section [013], options [1] and [2]). See Zone Definitions [001] [004]. If you change the zone supervision options from DEOL to EOL or from NC to DEOL (section [013], options [1] or [2]), power the system down completely, and then power it back up for correct operation.

Normally Closed (NC) Loops

To enable normally closed loops, programming section [013], option [1] must be ON.

NOTE: This option should only be selected if Normally Closed (NC) devices/contacts are being used.

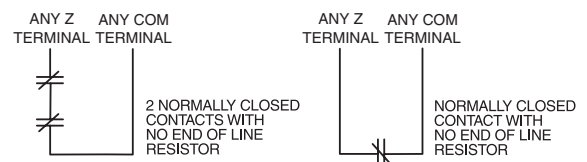

.....
 Normally Closed Loops. Section [013], Option [1]

Single End Of Line (EOL) Resistors

To enable panel detection of single end of line resistors, programming section [013], options [1] and [2] must be OFF.

NOTE: This option should be selected if either Normally Closed (NC) or Normally Open (NO) detection devices or contacts are being used.

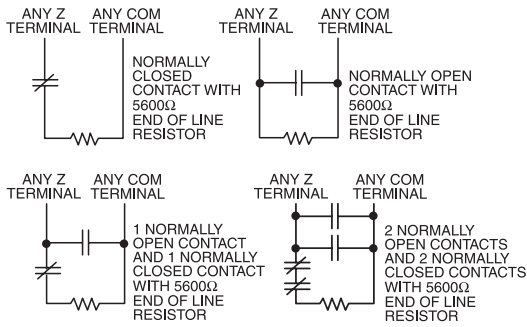

End of Line Resistors Section [013], Option [1]
 Single End of Line Resistors Section [013], Option [2]

Double End of Line (DEOL) Resistors

Double end of line resistors allow the panel to determine if the zone is in alarm, tampered or faulted. To enable panel detection of double end-of-line resistors, programming section [013], option [1] must be OFF and option [2] must be ON.

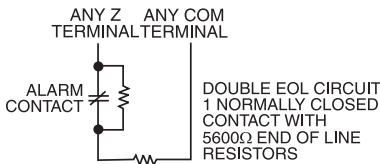

NOTE: If the double EOL supervision option is enabled, all hardwired zones must be wired for double EOL resistors, except for Fire and 24-hr Supervisory zones.

Do not wire DEOL resistors on keypad zones. Do not use DEOL resistors for Fire zones or 24-hr Supervisory zones. Do not wire Fire zones to keypad zone terminals if the DEOL supervision option is selected.

This option can only be selected if Normally Closed (NC) detection devices or contacts are being used. Only one NC contact can be connected to each zone.

The following chart shows zone status under certain conditions:

Loop Resistance	Loop Status
0Ω (shorted wire, loop shorted)	Fault
5600Ω (contact closed)	Secure
Infinite (broken wire, loop open)	Tamper
11200Ω (contact open)	Violated

End-of-Line Resistors Section [013], Option [1]
 Double End-of-Line Resistors Section [013], Option [2]

Fire Zone Wiring - 4-wire Smoke Detectors

All zones defined as Fire (see section 'Basic Programming PWS Sect 3') must be wired according to the following diagram:

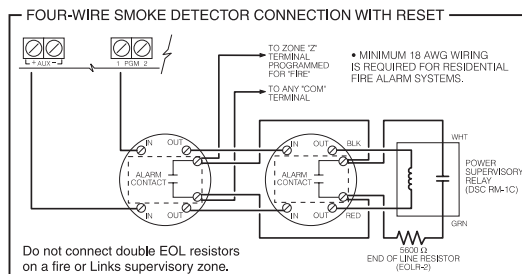

For a complete description of how fire zones operate, see section 'Basic Programming PWS Sect 3'.

Fire Zone Wiring - 2-wire Smoke Detectors

If PGM2 has been programmed for 2-wire smoke detector connection (see section 'Basic Programming PWS Sect 3'), the detectors must be wired according to the following diagram:

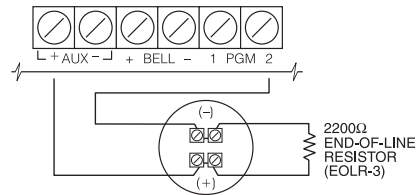

NOTE: If PGM2 is programmed for 2-wire smoke support, Jumper CON1 on the main board must be removed.

For a complete description of how fire zones operate, see section 'Basic Programming PWS Sect 3'.

Keyswitch Zone Wiring

Zones may be programmed to be used as keyswitch arming zones and must be wired according to the following diagram:

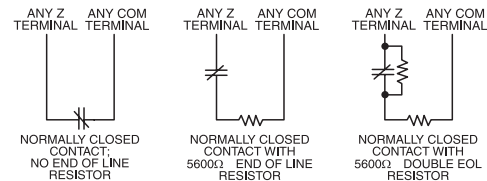

For a complete description of how keyswitch zones operate, see section 'Basic Programming PWS Sect 3'.

LINKS1000 Supervisory (24-hr Supervisory)

When using the LINKS1000 cellular communicator, any main board zone may be configured for LINKS1000 Supervision. Program this zone as zone type (09), 24-hr Supervisory in section [001].

With a 24-hr Supervisory zone, if the LINKS1000 experiences a trouble, the zone will be violated, causing the panel to report the event to the central station. This type of zone *always* requires a single EOL resistor (5600Ω). Refer to LINKS 1000 *Installation Manual* wiring diagram for installation.

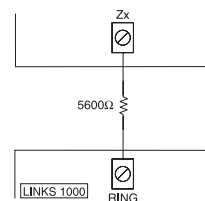

LINKS1000 Answer

If the LINKS1000 cellular communicator is being used a zone may be configured for LINKS1000 Answer to allow downloading to be performed in the event of telephone line failure. When the LINKS1000 receives a telephone call it will activate the RING terminal on the LINKS1000 circuit board. This terminal can be used to violate a zone programmed as (24) LINKS1000 Answer (see section 'Basic Programming PWS Sect 3'), causing the panel to seize the telephone line and begin communication with the downloading computer.

The zone programmed as LINKS1000 Answer ALWAYS requires a single EOL resistor (5600Ω) and must be wired according to the diagram above.

NOTE: The LINKS1000 Answer zone is only required for downloading to the panel via the LINKS1000, or for remotely connecting to the Escort5580(TC) module via the LINKS1000.

NOTE: When using the LINKS1000, Busy Tone Detection must not be used.

NOTE: Keypad zones cannot be used for 24-hr Supervisory or LINKS1000 Answer.

LINKS 2X50/LINKS 3000/Skyroute™

Refer to the LINKSX50, LINKS3000 and Skyroute™ Installation Manuals for wiring and installation details.

2.11 Keypad Zones

Keypads with zone inputs can be connected to devices such as door contacts. This saves you from running wires back to the control panel for every device.

To install the keypad, open the keypad plastic by removing the screw at the bottom of the unit. Locate the five terminals on the keypad circuit board. Connect the four Keybus wires from the control panel: the red wire to R, the black to B, the yellow to Y and the green to G.

To connect the zone, run one wire to the Z terminal and the other to B. For powered devices, use red and black to supply power to the device. Run the red wire to the R (positive) terminal and the black wire to the B (negative) terminal.

When using end of line supervision, connect the zone according to one of the configurations outlined in section 2.10 'Zone Wiring'.

Keypad circuit board

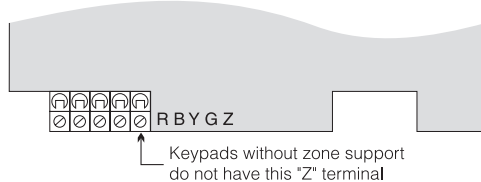

"Z" version keypads are also indicated by a label located on the back of the keypad plastic. The label reads: "Z" version.

NOTE: End of line resistors must be placed on the device end of the loop, not at the keypad.

NOTE: Keypad zones do not support DEOL resistors.

Assigning Keypad Zones

When using keypad zone inputs, each input used must be assigned a zone number in Installer Programming.

First, ensure that you have enrolled all installed keypads into the desired slots (see section 'Keypad Assignment').

Next, enter programming section [020] to assign the zones. There are eight programming locations in this section, one for each keypad slot. Enter a 2-digit zone number for each of the keypad zones. This number must be entered in the location corresponding to the keypad to which each zone is connected.

NOTE: If a keypad zone input is assigned on a zone numbered from 1 to 8, the corresponding zone cannot be used on the main control panel.

Once the keypad zones are assigned, you must also program zone definitions and zone attributes (see section 5.3 Basic Programming and Section 5.4 Advanced System Programming)

Section 3: How to Program

The following section of the manual describes how to enter Installer Programming and how to program the various sections.

NOTE: *It is extremely important that you read the following section of the manual to completely understand how to program the panel.*

3.1 How to Enter Installer Programming

Installer Programming is used to program all communicator and panel options. The **Installer Code** is [5555] at default, but should be changed to prevent unauthorized access to programming.

NOTE: *Once Installer Programming is exited, the system will reset. This will take 15 seconds. Do not attempt to perform any system function during this reset period. In addition, all outputs will return to their normal, deactivated state (or activated if inverted).*

LED Keypad

Step 1: From any keypad enter [*][8][Installer Code].

- The 'Program' light will flash to indicate you are in programming
- The 'Armed' light will turn on to indicate the panel is waiting for the 3-digit Section number to program

Step 2: Enter the 3-digit Section number you want to program.

- The Armed light will turn off
- The Ready light will turn on to indicate the panel is ready for the information for the selected Section

NOTE: *If the 3-digit section number entered is not valid or the module that pertains to the Section is not present, the keypad will sound a 2-second beep or error tone.*

LCD Keypad

Step 1: From any keypad enter [*][8][Installer Code].

The keypad will display 'Enter Section' followed by three dashes.

Step 2: Enter the 3-digit Section number you want to program.

The keypad will now display information for the section entered.

.....
Installer Code Section [006]
.....

3.2 Programming Decimal Data

When the Ready light is ON the panel is waiting for the information to be programmed for the selected Section. Enter the information written in the boxes for the Section found in the *Programming Worksheets*.

If a digit is entered for each program box in a Section the panel will automatically exit from the Section. It will turn OFF the Ready light and turn the Armed light back ON.

You can also press the [#] key to exit a Section before entering data for every box. This is handy if you only need to change the first few program boxes. All other locations in the Section will remain unchanged. If the [#] key is pressed the panel will turn OFF the Ready light, turn ON the Armed light and exit you from the Section.

3.3 Programming Hexadecimal Data

On occasion, hexadecimal (Hex) digits may be required. To program a Hex digit press the [*] key. The panel will enter Hex programming and Ready light will begin to flash.

The following table indicates which number should be pressed to enter the corresponding Hex digit:

1 = A 2 = B 3 = C 4 = D 5 = E 6 = F

After the correct Hex digit is entered the Ready light will continue to flash. If another Hex digit is required press the corresponding number. If a decimal digit is required press the [*] key again. The Ready light will turn on solid and the panel will return to regular decimal programming.

NOTE: *It is important to watch the Ready light. If the light is flashing any number you enter will be programmed as the Hex equivalent.*

Example: To enter 'C1' for a closing by user 1, you would enter [*] [3] [*], [1]

[*] to enter Hexadecimal mode (Ready light flashes)

[3] to enter C

[*] to return to decimal mode (Ready light is solid)

[1] to enter digit 1

If you enter information into a section and make a mistake, press the [#] key to exit the section. Select that section again and re-enter the information correctly.

If you are using a pulse communications format, a decimal zero [0] does not transmit. Programming a zero [0] tells the panel not to send any pulses for that digit. Decimal zero [0] is a filler digit. To make a zero [0] transmit, it must be programmed as a Hexadecimal 'A'.

Example: for the 3-digit account number '403', you would enter [4], [*] [1] [*] [3], [0].

[4] to enter the digit 4

[*] to enter Hexadecimal mode (Ready light flashes)

[1] to enter A

[*] to return to decimal mode (Ready light is solid)

[3] to enter the digit 3

[0] to enter the digit 0 as a filler digit.

3.4 Programming Toggle Options

Some Sections contain several toggle options. The panel will use zone lights 1 through 8 to indicate if the different options are enabled or disabled. Refer to the *Programming Worksheets* to determine what each option represents and whether the light should be ON or OFF for your application.

Press the number corresponding to the option to toggle the light ON or OFF.

Once all the toggle options have been selected correctly press the [#] key to exit the Section and save the changes. The panel will turn off the Ready light and turn on the Armed light.

3.5 Viewing Programming

LED and LCD5501Z Keypads

Any programming section can be viewed from an LED or LCD5501Z keypad. When a programming section is entered, the keypad will immediately display the first digit of information programmed in that section.

The keypad displays the information using a binary format, according to the following chart:

See Hex data entry instructions

Value	0	1	2	3	4	5	6	7	8	9	A	B	C	D	E	F
Zone 1	<input type="checkbox"/>	<input checked="" type="checkbox"/>	<input type="checkbox"/>	<input checked="" type="checkbox"/>	<input type="checkbox"/>	<input checked="" type="checkbox"/>	<input type="checkbox"/>	<input checked="" type="checkbox"/>	<input type="checkbox"/>	<input checked="" type="checkbox"/>	<input type="checkbox"/>	<input checked="" type="checkbox"/>	<input type="checkbox"/>	<input checked="" type="checkbox"/>	<input type="checkbox"/>	<input checked="" type="checkbox"/>
Zone 2	<input type="checkbox"/>	<input type="checkbox"/>	<input checked="" type="checkbox"/>	<input checked="" type="checkbox"/>	<input type="checkbox"/>	<input type="checkbox"/>	<input checked="" type="checkbox"/>	<input checked="" type="checkbox"/>	<input type="checkbox"/>	<input type="checkbox"/>	<input checked="" type="checkbox"/>	<input checked="" type="checkbox"/>	<input type="checkbox"/>	<input type="checkbox"/>	<input checked="" type="checkbox"/>	<input checked="" type="checkbox"/>
Zone 3	<input type="checkbox"/>	<input type="checkbox"/>	<input type="checkbox"/>	<input type="checkbox"/>	<input checked="" type="checkbox"/>	<input checked="" type="checkbox"/>	<input type="checkbox"/>	<input type="checkbox"/>	<input type="checkbox"/>	<input type="checkbox"/>	<input type="checkbox"/>	<input type="checkbox"/>	<input checked="" type="checkbox"/>	<input checked="" type="checkbox"/>	<input checked="" type="checkbox"/>	<input checked="" type="checkbox"/>
Zone 4	<input type="checkbox"/>	<input type="checkbox"/>	<input type="checkbox"/>	<input type="checkbox"/>	<input type="checkbox"/>	<input type="checkbox"/>	<input type="checkbox"/>	<input type="checkbox"/>	<input checked="" type="checkbox"/>	<input checked="" type="checkbox"/>	<input checked="" type="checkbox"/>	<input checked="" type="checkbox"/>	<input checked="" type="checkbox"/>	<input checked="" type="checkbox"/>	<input checked="" type="checkbox"/>	<input checked="" type="checkbox"/>

Zone Light OFF
 Zone Light ON

Press any of the Emergency keys (Fire, Auxiliary or Panic) to advance to the next digit.

When all the digits in a section have been viewed, the panel will exit the section: the Ready light will turn OFF, and the Armed light will turn ON, waiting for the next three-digit programming section number to be entered.

Press the [#] key to exit the section

LCD Keypad

When a programming section is entered, the keypad will immediately display all the information programmed in that section. Use the arrow keys (< >) to scroll through the data being displayed. To exit the section, scroll past the end of the data displayed, or press the [#] key.

Section 4: Keypad Commands

Use any system keypad to enter commands, or to program the PC5020 security system. The LED keypad uses function and zone indicator lights to represent alarm functions and status. The LCD keypad provides a written description on the liquid crystal display and uses function indicator lights to communicate alarm status to the user.

The *PC5020 User's Guide* provides basic directions for arming and disarming the system, bypassing zones and performing user functions from the keypads. The following sections provide additional details on these functions.

4.1 Arming and Disarming

Arming

The system cannot be armed unless the Ready light is on. If the Ready light is not on, ensure all protected doors and windows are secure and stop movement in areas covered by motion detectors.

When the Ready light is on, enter a valid access code. As each digit is pressed the keypad will beep. If an incorrect code is entered, the keypad will emit a steady 2-second beep to indicate that the code was not correct. If the code is correct but the Ready light was not on, the panel will beep six times rapidly followed by a long 2-second beep to indicate the system was not ready.

When the correct code is entered and the system is ready, the panel beeps six times rapidly, and the Armed light turns on. The panel begins counting down the Exit Delay. If the **Audible Exit Delay** option is enabled, the keypad will beep every second until the Exit Delay expires. The keypad will beep rapidly for the last 10 seconds of Exit Delay to warn the user the system is about to arm.

Exit the premises through the designated entry/exit door before the Exit Delay expires.

Users can restart the Exit Delay while it is counting down by pressing the Away key. The system will not log the user who re-started the Exit Delay, unless the **Quick Arming Disabled/Function Keys Require Code** option is turned on (Section [015], option [4]).

Other methods of arming are available (see Section "[*] [0] Quick Arm", "[*][9] Arming without Entry Delay", and section 4.4 'Function Keys').

NOTE: The PC5020 has a built-in feature called *Audible Exit Fault* (see Section 5.3 Basic Programming PWS Sect 3 [001]-[004] for more information).

Stay and Away Arming

When a user arms the system, if any zones on the system have been programmed as Stay/Away, the panel will immediately turn on the Bypass light. The panel will then monitor all zones programmed as Delay 1 and Delay 2. If no delay type zone is violated by the end of the Exit Delay (i.e., nobody leaves through the entry/exit door), the panel will bypass all Stay/Away type zones. The panel is now Stay armed. The Bypass light will remain on to inform the home owner that the interior protection is bypassed. This is a convenience for users that want to arm the panel while at home. Using this method, users do not have to bypass the interior zones manually.

Users can add the Stay/Away zones back into the system at any time by entering [*] [1] (see section '[*][1] Zone Bypassing'), or by using the Away function button.

If a delay zone is violated during the Exit Delay (i.e., somebody leaves through the designated entry/exit door), **all** zones will be active after the Exit Delay expires. The panel is now Away armed. The Bypass light on the keypad will be off.

Other methods of Stay and Away arming are available (see section 'Function Keys').

Using the Away Button While Stay Armed

If a partition is armed in Stay mode and a user wishes to leave the premises without having to disarm and re-arm the system, they may press the Away button. The system will begin counting the standard Exit Delay, allowing the user to leave without actually disarming. The panel will log 'Armed in Away Mode' upon completion of the Exit Delay. This feature is useful for users with Wireless Keys with Stay/Away buttons, and who wish to have their panel armed at all times.

Using the Stay Button While Away Armed

Pressing the Stay key while a partition is Away armed will begin the Exit Delay again. The panel will log 'Armed in Stay Mode'. This feature is useful for users with wireless keys with Stay/Away buttons, and who wish to have their panel armed at all times.

NOTE: If function keys require the entering of an access code, a valid access code must be entered to toggle between arming modes. The access code used to perform this function will be logged with 'User Log User XX'. Swinger shutdown will be reset if the Stay or Away buttons are pressed while the system is armed.

Disarming

To disarm the panel, enter the premises through the designated entry/exit door. The keypad will emit a steady beep to warn that you must disarm the system. During the last 10 seconds of entry delay the panel will pulse the keypad beeper on and off rapidly to warn that the entry delay is about to expire.

Enter a valid access code at the keypad. If an error is made, re-enter the code correctly. When a correct code is entered the keypad will turn off the Armed light and stop the keypad buzzer.

If an alarm occurred while the panel was armed the Memory light and the zones which caused the alarm will be flashing. Press the [#] key to return the keypad to the Ready state.

Event Buffer

The panel will store the last 256 events that have occurred on the system. Each event will contain the time, date, partition and the event itself along with the zone number, access code number or any other information pertaining to the event.

If the **Event Buffer Follows Swinger Shutdown** feature is enabled the event buffer will not store events after the swinger shutdown level has been reached. This will prevent the panel from overwriting the entire buffer if a problem exists (see Section 5.3 Basic Programming PWS Sect 3 [377]). The event buffer can be viewed three different ways. It can be viewed through an LCD keypad, printed on-site using the PC5400 printer module, or it can be uploaded through the DLS software.

Viewing the Event Buffer

The following is the procedure for viewing the event buffer through the LCD keypad:

- Step 1 - Enter [*] [6] [Master Code]
- Step 2 - Select 'View Event Buffer'

The keypad will display the event number, partition, time and date of the event in question. Use the [*] key to toggle between this information and the event itself. Use the arrow keys (<>) to scroll through the events in the buffer. When you have finished viewing the event buffer press the [#] key to exit.

NOTE: When viewing events for partitions 3 to 8 on a PKP-LCD v2.x and lower keypad, they will show as being logged in the 'System Area'.

4.2 [*] Commands

[*][1] Zone Bypassing

Users can bypass individual zones using the [*][1] keypad command. This command can be used if users want to have access to an area while the partition is armed, or to bypass a defective zone (bad contact, damaged wiring) until service can be provided.

A bypassed zone will not cause an alarm. Instructions on zone bypassing can be found in the *PC5020 User's Guide* ('Zone Bypassing').

When the partition is disarmed, all zones bypassed using [*][1] will be unbypassed, except for 24-Hr zones.

If the **Code Required for Bypass** option is enabled, an access code will be required to enter the Bypass mode. Only access codes with the Bypass attribute enabled will be able to bypass zones (see section '[*][5] Programming Access Codes').

These features are also available on the [*][1] zone bypassing menu:

- **Bypass Recall:** Press [99] while in the [*][1] menu to recall the last set of bypassed zones.
- **Clear Bypasses:** Press [00] while in the [*][1] menu to clear all bypassed zones.
- **Bypass Groups:** Users can program a group of zones to be bypassed (bypass group). Each partition can have a different bypass group. To program a bypass group, in the [*][1] menu, select the zones to be bypassed. Press [95] to save the group. To recall the group, press [*][1] followed by [91].

If the Code Required for Bypass option is enabled, the Master code or Supervisor codes must be used to access this feature.

NOTE: If a 24-hr zone is bypassed, ensure that the zone is restored or disabled before removing the bypass.

Code required for bypass Section [015], Option [5]

[*][2] Trouble Display

The panel constantly monitors itself for several different trouble conditions. If a trouble condition is present, the Trouble light will be ON and the keypad will beep twice every 10 seconds. The trouble beep can be silenced by pressing any key on any keypad. If **Bell Squawk on Trouble** is enabled (section [014], option[5]), the bell will squawk every 10 seconds when a Trouble condition is present.

NOTE: If there is an AC Trouble, the keypad will not beep for a General System Trouble.

To view Trouble conditions from an LED or LCD5501Z keypad:

1. Press [*][2].
2. The keypad will flash the Trouble light. The zone indicator lights corresponding to the present Trouble conditions will be ON.

When using an LCD keypad, the Trouble conditions will be listed on the display. Users can scroll through the list of present Trouble conditions using the arrow (<>) keys.

NOTE: Troubles can be viewed while armed using the LCD keypad, provided the keypad is version 2.0 or later. Older keypads will incorrectly display 'Fire Trouble'. If using older LCD keypads, program section [013], option [3] as OFF to ensure that Troubles are displayed correctly.

The various Troubles are described below:

Light	Trouble
1	<p>Service Required: Press [1] to determine the specific Trouble. Lights 1 - 8 will light up to indicate the Trouble:</p> <ul style="list-style-type: none"> • Light [1] Low Battery: Main panel backup battery charge is low (below 11.5 volts under load). Trouble is restored when the battery charges over 12.5 volts. • Light [2] Bell Circuit Trouble: The bell circuit is open (see section 'Terminal Descriptions'). • Light [3] General System Trouble: One or more of the following Troubles has occurred: the PC5204 power supply module has an AUX failure, PC5204 Output #1 Trouble, Camera Trouble, Home Automation Trouble on the Escort5580(TC), or a printer connected to the PC5400 printer module has a fault and is off-line. Users can view specific conditions in the event buffer. • Light [4] General System Tamper: Tamper has been detected in a module. • Light [5] General System Supervisory: The panel has lost communication with a module connected to the Keybus (See section 2.8 'Confirming Module Supervision'). The event buffer will log the event. • Light [6] RF Jam: Please refer to the PC5132 <i>Installation Manual</i> for more information. • Light [7] PC5204 Low Battery: The PC5204 module has a low backup battery. • Light [8] PC5204 AC Failure: The PC5204 module has lost AC power. <p>NOTE: If you remove and then restore power to the main panel in order to service any PC5204 module, or any module being powered by a PC5204, you must also remove and then restore power to the PC5204 and any connected modules. This ensures that any Troubles present on the module are correctly logged and/or annunciated.</p>
2	<p>AC Failure: AC power is no longer being supplied to the control panel. The Trouble light will flash if an AC Failure is present, if the Trouble Light Flashes if AC Fails option is programmed (section [016], option [2]). This trouble will not be displayed if the AC Trouble Displayed option is disabled (section [016], option [1]).</p>
3	<p>Telephone Line Monitoring Trouble (TLM): There is a problem with the telephone line. If the system has a LINKS1000, or an alternate communicator, this trouble can be reported to the central station by programming reporting codes in sections [345] and [346].</p>
4	<p>Failure to Communicate (FTC): The communicator failed to communicate with any of the programmed telephone numbers (see section 5.6 'Communicator Programming').</p>
5	<p>Zone Fault (including Fire Zone): A zone on the system is experiencing trouble, meaning that a zone could not provide an alarm to the panel if required to do so (e.g., a fire zone is open, or there is a short on a DEOL zone, or a supervisory fault on a wireless zone). When a zone fault occurs, the keypad(s) on the system will start to beep. Press [5] while in Trouble mode to view the affected zones.</p> <p>NOTE: A Fire zone trouble will be generated and displayed in the armed state.</p>

Light	Trouble
6	Zone Tamper: A zone configured for double end of line resistor supervision has a tamper condition, or the tamper switch is open on a wireless device. When a tamper condition occurs, the keypad(s) will start to beep (if the system is armed, an alarm will occur). Press [6] while in Trouble mode to view the affected zones. If a zone is tampered or faulted, it must be fully restored to clear the trouble.
7	Device Low Battery: A wireless device has a low battery condition. Press [7] one, two, or three times to view which devices are experiencing battery failure. An LED keypad will indicate battery failure using zone lights. The following will occur: Keypad beeps: Keypad displays: Press [7] 1) Zones with low batteries (LED keypad - zone lights 1 to 32) Press [7] again 2) Handheld keypads with low batteries (LED keypad - zone lights 1 to 4) Press [7] again 3) Wireless keys with low batteries (LED keypad - zone lights 1 to 16)
8	Loss of System Time: When the panel is powered up, the internal clock needs to be set to the correct time. This trouble is cleared when an attempt is made to reset the clock. This is set in '[*][6] User Functions' Programming on page 16.

[*] [3] Alarm Memory

The memory light will be on if any alarm occurred during the last armed period or if an alarm occurred while the panel was disarmed (24-hr zones). Instructions on viewing alarms in memory are located in the *PC5020 User's Guide* ('Disarming the System').

[*] [4] Door Chime On/Off

If enabled the keypad will beep 6 times rapidly when a zone is tripped and restored. The panel will only do this for zones with the Door Chime attribute enabled and if the door chime feature is enabled (see *Section 5.4 Advanced Programming [101]-[164]*).

[*] [5] Programming Access Codes

All access codes can arm and disarm any partition they are enabled for, and can activate the PGM outputs using the [*][7] commands (see section '[*] [7] Command Output Functions').

For instructions on programming access codes, see the *PC5020 User's Guide* ('Programming Access Codes').

The available access codes are as follows:

General Access Codes - Access Codes [01] to [32]

Each access code can be used to arm and disarm the assigned partitions. Additional access code attributes are also programmable to determine what abilities the code will have.

You can program partition assignments and access code attributes by following the instructions in this section.

Duress Codes - Access Codes [33] and [34]

When a Duress Code is used to perform any function the panel will send a Duress reporting code to the central station (see *Section 5.3 Basic Programming [001]-[004]* and *Section 5.6 Communicator Programming*).

Supervisor Codes - Access Codes [41] and [42]

Supervisor Codes can program additional access codes. By default, Supervisor codes have the same partition and attribute programming as the Master code. You can change the partition and attribute programming for these codes by following the instructions in this section.

System Master Code - Access Code [40]

By default the System Master Code is enabled to operate on all partitions, and can perform any keypad function. This code can be used to program all access codes, including the Supervisor Codes and Duress Codes.

If the **Master Code Not Changeable** option is enabled the System Master Code can only be changed using Installer Programming.

Maintenance Code

The maintenance code can only be used to arm and disarm the system. It cannot be used to bypass zones, to access the Escort5580(TC), or to cancel or postpone automatic arming. The code can only be programmed in Installer Programming.

Programming Partition Assignments and Access Code Attributes

You can enable or disable each access code to work on each partition. Additional access code attributes are also programmable. Attributes determine what abilities the code will have.

By default, each code has the attributes of the code used to program it. For example, if you use the Master Code to program other access codes, the new codes will have the same attributes as the Master Code. You can change the partition and attribute programming by following the instructions described below.

You cannot change Master Code partition or attribute programming. The Master Code has all partitions and all attributes turned on, except for the Bell Squawk on Arming/Disarming attribute.

To program which partition(s) each code will work on:

1. Enter [*][5][Master Code][8] to enter partition programming.
2. Enter the 2-digit number of the access code you want to edit.
3. Enter the partition number (1-8) to toggle it on or off.

NOTE: Partition programming is NOT supported at the following keypads: PC5508(Z), PC5516(Z), PC5532(Z) versions v2.00 and lower; LCD5500(Z) version 2.x and lower; LCD5501Z version 1.x and lower.

To program each attribute:

1. Enter [*][5][Master Code][9] to enter the attribute programming mode.
2. Enter the 2-digit number of the access code you want to edit.
3. Enter the attribute number to toggle it on or off.

The programmable attributes are as follows:

- **Attributes 1-2:** For Future Use.
- **Attribute 3:** Zone Bypass enabled.
This attribute allows the user to bypass zones.
- **Attribute 4:** Escort5580(TC) Remote Access
This attribute allows the user to access the security system via the Escort, if installed.
- **Attribute 5:** Downlook Remote Trigger to Telephone Number 1. For use with the Escort5580(TC) and the PC5108L/DLM-4L (see the *PC5108L Installation Manual* for details).
- **Attribute 6:** Downlook Remote Trigger to Telephone Number 2. For use with the Escort5580(TC) and the PC5108L/DLM-4L (see the *PC5108L Installation Manual* for details).
- **Attribute 7:** Bell Squawk on Arming/Disarming. When this attribute is turned on, the bell will squawk when the access code is entered to arm or disarm the system. For example, you can use the arm/disarm bell squawk attribute to have wireless key access codes squawk the bell, while other codes are silent. To do this, enable attribute [7] on all access codes associated with wireless keys.

NOTE: If you enable the Bell Squawk on Arming/Disarming option (section [014], option [1]), the bell will sound arm/disarm bell squawks for all access codes, regardless of the programming for attribute [7] (See Section 5.3 Basic Programming PWS Sect 3 [001]-[004] and Section 5.4 'Advanced Programming').

Installer Programming - Codes and Options

There are three codes which can be programmed by the installer in Installer Programming: the **Master Code**, the **Installer Code**, and a **Maintenance Code**. All other access codes can be programmed through the [*][5] command, as described previously in this section.

The master code can also be programmed by the user as access code (40). However, if the **Master Code Not Changeable** option is enabled, the Master Code can only be changed in Installer programming.

The Maintenance Code can only be used to arm and disarm the system. The Maintenance Code cannot bypass zones, use [*][9] to arm the system, cancel auto-arming, or perform [*][7] command functions. There will be no arm/disarm bell squawks when the Maintenance Code is used. General access codes can arm and disarm the system. When the **Code Required for Bypassing** option is enabled, users will need to enter a valid access code in order to bypass zones. Individual access codes can have the Zone Bypassing attribute disabled under Access Code Attribute programming, as described previously in this section.

Installer Code	Section [006]
Master Code	Section [007]
Maintenance Code	Section [008]
Master Code Not Changeable	Section [015]: [6]
Code Required for Bypassing	Section [015]: [5]

NOTE: Only one partition at a time can use [*][5] programming.

[*] [6] User Functions

NOTE: Only one partition at a time can use [*][6] programming.

To program user functions, perform the following:

1. Press [*] [6] [Master Code]. The keypad will flash the 'Program' light.
2. Press the number [1] to [5] for the item to be programmed.

- **[1] - Time and Date**

See the *PC5020 User's Guide* for instructions on setting the time and date ('Setting the Time and Date').

- **[2] - Auto-arm Enable/Disable**

Enter [2] to enable (three keypad beeps) or disable (one long beep) the auto-arm feature.

- **[3] - Auto-arm Schedule**

Enter [3] to change the auto-arm time for each day of the week.

Scroll to the day of the week you want to change, or enter the number of the day (1-7 for Sunday to Saturday). On an LED keypad, zone lights 1-7 will represent Sunday to Saturday.

When you have selected a day, enter the auto-arm time in 24-hr format (i.e., enter a 4-digit number in [hhmm] format).

The system will return you to the day selection menu. Scroll to the next day you want to program, or to exit auto-arm programming, press [#].

NOTE: To change the Auto-arm schedule at another partition, users with access to that partition will have to select the partition on the keypad, before entering the

Auto-arm Schedule menu. See section 4.4 'Global and Partition Keypad Operation' for more information.

NOTE: Only PKP-LCD v2.0 or greater keypads support the [*][6][3] menu option.

- **[4] - System Test**

When [4] is pressed the panel will perform the following.

- sound the alarm output for two seconds
- light all lights and display pixels on the keypad
- sound the keypad buzzer for two seconds
- test the main panel/PC5200/PC5204 battery
- send a System Test Reporting code, if programmed.

For step-by-step instructions on performing a system test, see the *PC5020 User's Guide* ('Full System Test').

- **[5] - Enable DLS (Downloading)**

When [5] is pressed the panel will turn on the downloading option for 6 hours. During this time the panel will answer incoming downloading calls (see Section 5.7 Downloading Options PWS Sect 7)

- **[6] - User-initiated Call-Up**

When [6] is pressed, the panel will initiate a call to the downloading computer.

LCD Keypad User Functions

Additional features are available using on the LCD keypad. These features do not have numbers assigned. Use the arrow keys (< >) to scroll through the [*] [6] menu and press the [*] key to select the following commands.

View Event Buffer: The 256 event buffer can be viewed through any LCD keypad.

- **Brightness Control:** When this option is selected the keypad will allow you to scroll through 10 different backlight level options. Use the arrow keys (<>) to scroll to the desired backlight level and press the [#] key to exit.

- **Contrast Control:** When this option is selected the keypad will allow you to scroll through 10 different contrast level options. Use the arrow keys (<>) to scroll to the desired contrast level and press the [#] key to exit.

- **Keypad Buzzer Control:** When this option is selected the keypad will allow you to scroll through 21 different keypad sounder tone options. Use the arrow keys (<>) to scroll to the desired keypad beeper level and press the [#] key to exit. This function can be achieved on LED keypads by holding the [*] key.

[*] [7] Command Output Functions

There are four output functions available to the user. Entering [*] [7] [1-4] [Access Code, if required] will activate any output programmed for options [19]-[22] (respectively). Each function can be performed when the system is either armed or disarmed.

For more information regarding these output types, (see Section 5.8 Programmable Output Programming).

[*] [8] Installer Programming

Enter [*][8] followed by the Installer Code to enter Installer Programming.

[*] [9] Arming Without Entry Delay

When a partition is armed with the [*][9] command the panel will remove the entry delay from the partition. After the Exit Delay, Delay 1 and Delay 2 type zones will be instant and Stay/Away zones will remain bypassed. (see section 'Basic Programming PWS Sect 3').

For more information regarding this feature, see the *PC5020 User's Guide*.

The entry delay can be activated or deactivated at any time while the system is armed by pressing [*][9].

NOTE: Global Delay zones will always have an entry delay, even if the system is armed using [*][9].

[*] [0] Quick Arm

If the **Quick Arm Enable** option is enabled the panel can be armed by entering [*][0]. This is a useful method of arming a partition when someone without an access code will be required to arm a partition.

[*] [0] Quick Exit

Quick Exit will allow someone to leave an armed premise through a Delay type zone without having to disarm and rearm the system.

When [*][0] is entered, if the Quick Exit Enabled option is enabled, the panel will provide a 2-minute window to exit. During this time the panel will ignore the first activation of a Delay type zone. When the Delay zone is secured the panel will end the 2-minute time period.

If a second Delay zone is tripped, or if the zone is not restored after two minutes, the panel will start entry delay.

NOTE: If Quick Exit is used on a partitioned system, Keypad Blanking and Access Code Required to Remove Blanking should be enabled.

Quick Arm Enable	Section [015], Option [4]
Quick Exit Enable	Section [015], Option [3]

4.3 Function Keys

There are five function keys on the PC5020 keypads labelled Stay, Away, Chime, Reset and Exit. The operation of these keys is described below. The function is activated by pressing and holding the key for 2 seconds.

'Stay' - Stay Arm

Arms the partition to which the keypad is assigned. All Stay/Away type zones will be automatically bypassed. Delay type zones will provide entry and Exit Delay. The Quick Arm feature must be enabled for this key to function (*Section [015], Option [4]*). If Quick Arming is not enabled, the user must enter their access code after pressing the function key in order to arm the system in the Stay mode.

'Away' - Away Arm

Arms the partition to which the keypad is assigned. All Stay/Away type zones will be active at the end of the Exit Delay. Delay type zones will provide entry and Exit Delay. The Quick Arm feature must be enabled for this key to function (*Section [015], option [4]*). If Quick Arming is not enabled, the user must enter their access code after pressing the function key in order to arm the system in the Away mode.

'Chime' - Door Chime On/Off

Pressing the key will toggle the Door Chime feature ON or OFF. One solid beep means the feature has been disabled, three short beeps means it has been enabled.

'Reset' - Reset Smoke Detectors

Pressing this key will cause the panel to activate for 5 seconds any output programmed as Sensor Reset. (see section [*] [7] Command Output Functions').

'Exit' - Activate Quick Exit

Pressing this key will cause the panel to activate the Quick Exit feature (see section [*] [0] Quick Exit').

Function Key Options

The programming of any function key on any keypad may be changed to one of the options listed below (see section 2.7 'Keypad Assignment' for instructions on changing function key programming.)

[00] - Null Key

The key is not used and will perform no function when pressed.

[01] - Select Partition 1

Provides an easy way to select partition 1. This is the same as pressing and holding the [#] key then pressing and holding the [1] key to select partition 1 (see section 'Global and Partition Keypad Operation').

[02] - Select Partition 2

Provides an easy way to select partition 2. This is the same as pressing and holding the [#] key then pressing and holding the [2] key to select partition 2 (see section 'Global and Partition Keypad Operation').

[03] - Stay Arm

Same as described in Function Keys - Section 3.5.

[04] - Away Arm

Same as described in Function Keys - Section 3.5.

[05] - [*][9] No Entry Delay Arm

After this function key is pressed the user must enter a valid access code. The partition will arm and remove entry delay from the partition when the Exit Delay expires (see section [*] [9] Arming Without Entry Delay').

[06] - [*][4] Door Chime On/Off

This function key provides the user a simple method for turning the Door Chime feature on and off (see section [*] [4] Door Chime On/Off').

[07] - [*][6]...[4] System Test

This function key provides the user with a simple method for testing the system (see section [*] [6] User Functions'). A valid Master Code is required to perform this command.

[08] - [*][1] Bypass Mode

This function key provides the user with a simple method for entering the Bypass Mode. If an access code is required it must be entered before bypassing can be performed (see section [*][1] Zone Bypassing').

[09] - [*][2] Trouble Display

This function key provides the user with a simple method for entering the Trouble Display mode (see section [*][2] Trouble Display').

[10] - [*][3] Alarm Memory

This function key provides the user with a simple method for entering the Alarm Memory Display mode (see section [*] [3] Alarm Memory').

[11] - [*][5] Programming Access Codes

This function key provides the user with a simple method for programming access codes. After this key is pressed a valid System Master or Supervisor Code will have to be entered before the panel will allow programming to be performed (see section 4.2 ' [*] Commands').

[12] - [*][6] User Functions

This function key provides the user with a simple method for programming user functions. Once this key is pressed a valid System Master Code or Partition Master Code must be entered before the panel will allow User Functions to be performed (section 4.2 ' [*] Commands').

[13] - [*][7]+[1] Command Output Option 1

This function key provides the user with a simple method for activating a PGM output programmed as Command Output Option 1 (see Section 5.8, *Programmable Output Programming*). By default, after this key is pressed a valid access code must be entered (section 4.2 ' [*] Commands').

[14] - [*][7]+[2] Smoke Detector Reset

This function key provides the user with a simple method for activating a PGM output programmed as either option [03] Sensor Reset or [20] Command Output option 2.

[15] - General Voice Prompt Help

This feature can only be programmed if both the Escort5580(TC) and the PC5936 audio matrix module are being used.

When the function key is pressed, the intercoms will perform a Help page. The user must then press the Page/Answer button on any intercom station to begin the help session with the Escort.

For more information, see the *PC5936 Installation Manual*.

NOTE: While the voice prompt help is active, users will not be able to disarm the system using wireless keys.

[16] - [*]+[0] Quick Exit

Same as described in 'Function Keys' - Section 3.5.

[17] - [*]+[1] Reactivate Stay/Away Zones

This function key provides the user with a simple method for adding Stay/Away zones back into the system (*section 4.2 '[*] Commands'*).

[18] Identified Voice Prompt Help

This feature can only be programmed if the Escort5580(TC) and the PC5936 audio matrix module are being used.

When the function key is pressed, the Escort5580(TC) will begin a help session from the intercom station programmed as closest to the keypad. In order for this option to function, you must program PC5936 Section [802], subsection [14] 'Keypad Port Assignments.' For more information, Refer to the *PC5936 Installation Manual*.

NOTE: This function key cannot be programmed for PC55XXZ LED keypads with software version 1.0.

NOTE: While the voice prompt help is active, users will not be able to disarm the system using wireless keys.

[19] - [*]+[7]+[3] Command Output 3

[21] - [*]+[7]+[4] Command Output 4

Function keys [19] and [21] provide the user with a simple method of activating an output programmed as Command Output Option 3 or 4.

[22] - Active Camera Monitor Selection

This function key is for use with the PC5108L Downlook interface/camera monitor module. For instructions on the function key use, see the *PC5108L Installation Manual*.

[23] - Bypass Recall

Pressing this function key will recall the last group of bypassed zones. The function key will follow the **Code Required for Bypass** option. If the option is enabled, a valid access code with the Bypass attribute enabled must be entered after the function key is pressed. For instructions on zone bypassing, see the *PC5020 User's Guide*.

[24] - Recall Bypass Group

This function key will recall zones in the Bypass Group for the partition. This group is programmed by the user in the [*][1] Bypass menu. The function key will follow the **Code Required for Bypass** option. If the option is enabled, a valid access code with the Bypass attribute enabled must be entered after the function key is pressed. For instructions on zone bypassing and programming Bypass Groups, see the *PC5020 User's Guide*.

[25]-[26] - For Future Use

[27] - Select Partition 3

[28] - Select Partition 4

[29] - Select Partition 5

[30] - Select Partition 6

[31] - Select Partition 7

[32] - Select Partition 8

These keys provide users with an easy way to select one of the above partitions. For example, this is the same as pressing and holding the [#] key, then pressing and holding the [3] key to select partition 3 (see section 'Global and Partition Keypad Operation').

4.4 Global and Partition Keypad Operation

A global keypad will display limited information until a partition is selected: the Trouble light will turn on if a trou-

ble condition is present, and the Armed light will turn on if all the partitions are armed. To select a partition the user must press and hold one of keys [1] - [8] for two seconds, depending on which partition they want to access (e.g., press and hold [2] for partition 2). The keypad will then display the status of the selected partition and allow normal operation.

A partition keypad will display the status of the partition to which it is assigned. A user with access to more than one partition may temporarily assign the keypad to another partition to gain access. To do this the user must first press and hold the [#] key for two seconds. The keypad will go blank. The user must then press and hold one of keys [1] - [8] for two seconds, depending on which partition they want to access (e.g., press and hold [2] for partition 2). The keypad will then display the status of the selected partition and allow normal access.

4.5 Features Available for the LCD5500Z

These features are only available for LCD5500Z keypads with zone inputs:

Automatic Scrolling of Open Zones

The LCD5500Z keypad (v3.1 and higher) automatically scrolls through open zones while the keypad is idle. This feature, if enabled, will override the clock display. This option can be programmed in LCD programming section [076], Option [8].

Automatic Scrolling of Alarms in Memory

The LCD5500Z keypad allows automatic scrolling through alarms in memory while the keypad is idle. This feature, if enabled, will override the clock display. This option can be programmed in LCD programming section [076], Option [4].

24-hr Time Display Option

The LCD5500Z can be programmed to display time using a 24-hr clock, instead of a 12-hour, a.m./p.m. clock. This option can be programmed in LCD programming section [076], Option [3].

Keypad Zones

See section 2.11 'Keypad Zones'.

Viewing Troubles While Armed

See section 4.2 '[*] Commands' for information on how to view troubles.

Backlighting Boost (available for all zone input keypads)

The LCD5500Z and PC55xx zone input keypads will provide extra number pad lighting when any key is pressed. The backlighting boost will last for an additional 30 seconds after the last keypress.

Prompts for the following features are only supported by LCD5500(Z) v2.x and higher:

- Downlook Support (DLM-4L/PC5108L): Active Camera Monitor Selection, Remote Trigger
- Auto-arm features: Late to Close, Auto-arm Postpone/Cancel, Auto-arm by Day
- Bypass Groups

Section 5: Programming Sections

The structure of this section corresponds with the structure of the Programming Worksheets (PWS) and is intended to be used with them. Paragraph 5.1 corresponds with Section 1 etc. Table 5-1 references the paragraphs in this section with the corresponding location in the programming worksheets.

Table 5-1 - SECTION 5 CONTENTS			
Sect	Item	Sect	Item
Para 5.1	For the Record	378	Test Transmission Time of Day
Para 5.2	Keypad Programming	380	First Communicator Option Code
Para 5.3	Basic Programming	381	Second Communicator Option Code
001-004	Zone Definitions	382	Third Communicator Option Code
005	System Times	390	LINKS1000 Preamble (First Telephone Number)
006-008	Special Access Codes	391	LINKS1000 Preamble (Second Telephone Number)
009-011	Programmable Output Options	392	LINKS1000 Preamble (Third Telephone Number)
012	Keypad Lockout Options	393	LINKS1000 Special Function Preamble (All Phone Nos.)
013	First System Option Codes	Para 5.7	Downloading Options
014	Second System Option Codes	401	First Downloading Option Code
015	Third System Option Codes	402	Downloading Computer's Telephone Number (32 Digits)
016	Fourth System Option Codes	403	Downloading Access Code
017	Fifth System Option Codes	404	Panel Identification Code
018	Sixth System Option Codes	405	Answering Machine Double-Call Timer
020	Keypad Zone Assignments	406	Number of Rings to Answer On
030	Zone Loop Response Option Code	490	Links Preamble (Downloading Telephone Number)
Para 5.4	Advanced System Programming	499	Initiate PC-Link Downloading
101-164	Zone Attributes	Para 5.8	Programmable Output Programming
165-178	System Timers	501-502	Main Board
181-188	Automatic Arming Schedule	503-504	Main Board / PC5208
190-198	No Activity Arming Pre-Alert	505-510	PC5208
199	Auto Arming Pre-Alert Timer	511-514	PC5204
Sect 5	Partition and Zone Programming	551-552	Main Board
201	Partition Selection Mask	553-554	Main Board/PC5208
202-265	Assigning Zones to Partitions	555-560	PC5208
Sect 6	Communicator Programming	561-564	PC5204
301-304	Telephone Numbers	Para 5.9	International Programming
310	System Account Code	700	Clock Adjust
311-318	Partition Account Code	701	First International Options Code
320-323	Alarm Reporting Codes, Zones 01-64	702	Second International Options Code
324-327	Alarm Restoral Reporting Codes, Zones 01-64	703	Delay between Dialing Attempts
328	Miscellaneous Alarm Reporting Codes	Para 5.10	Module Programming
329	Priority Alarm and Restoral	801	PC5400 Printer Module Programming
330-333	Tamper Reporting Codes, Zones 01-64	802	PC59XX Audio Interface Programming
334-337	Tamper Restoral Reporting Codes, Zones 01-64	803	Alternate Communicator Programming
338	Miscellaneous Tamper Reporting Codes	804	PC5132
339-340	Closing (Arming) Reporting Codes, Access Codes 1-32	805	PC5100
341	Miscellaneous Closing (Arming) Reporting Codes	806	PC5108L
342-343	Opening (Disarming) Reporting Codes, Codes 1-32	Para 5.11	Special Installer Functions
344	Miscellaneous Opening (Disarming) Reporting Codes	901	Installer Walk Test Mode Enable / Disable
345	Maintenance Alarm Reporting Codes	902	Module Supervision Reset
346	Maintenance Restoral Reporting Codes	903	Module Supervision Field
347	Miscellaneous Maintenance Reporting Codes	904	Wireless Module Placement Test
348	Test Transmission Reporting Codes	906	Local Test of Downlook Remote Trigger
349	PC5700 Maintenance Reporting Codes	990	Installer Lockout Enable
350	Communicator Format Options	991	Installer Lockout Disable
351-358	Alarm/Restore Communicator Call Directions	993	Restore Alternate Communicator Default Programming
359-366	Tamper/Restore Communicator Call Directions	995	Restore Escort5580(TC) to Factory Default Programming
367-374	Opening/Closing Communicator Call Directions	996	Restore PC5132 to Factory Default Programming
375	System Maintenance Communicator Call Directions	997	Restore PC5400 to Factory Default Programming
376	System Test Transmissions Communicator Call Directions	998	Restore PC5936 to Factory Default Programming
377	Communication Variables	999	Restore PC5020 to Factory Default Programming

5.1 For the Record PWS Sect 1

This Section identifies the client, installation date, Installer Code, hardware configuration and programming summary for each zone. Remove these pages and retain for reference.

5.2 Keypad Programming PWS Sect 2

Refer to Section 2.6 'Keypad Assignment'

5.3 Basic Programming PWS Sect 3

[001]-[004] - Zone Definitions

These sections require 16 2-digit entries. Each 2-digit number entered determines how a zone will operate.

NOTE: In addition to selecting how each zone will operate, attributes can be programmed by zone (see section 'Advanced Programming PWS Sect 4' [101]-[164]).

[001]-[004] ZONE DEFINITIONS		
Option	Zone Type	Description
00	Null Zone	For zones that are not used and do not require a closed loop or EOL resistor
01	Delay 1	Follows the Entry Delay 1 and Exit Delay programmed in Section [005] and is normally used for Entry/Exit doors. The Exit Delay starts as soon as the panel is armed. The zone may be opened and closed during the delay time without causing an alarm. After the Exit Delay time has expired, opening the zone will start the Entry Delay timer. During the Entry Delay time, the keypad buzzer will sound steadily to advise the user that the system should be disarmed. If the panel is disarmed before the Entry Delay expires, no alarm will be generated.
02	Delay 2	Operates the same as Type [01] zone except the Entry Delay time can be independently set in Section [005]. The Exit Delay time is common to both zone types.
03	Instant	Normally used for door and window contacts and has the standard Exit Delay, but is instant when opened after the Exit Delay expires
04	Interior	Used with interior motion detectors. Interior zones feature an Exit Delay and an Entry Delay provided that any Delay type zone has been tripped first. If the protected area is entered without coming through the a delayed entrance and an Interior zone is tripped, an immediate alarm will be generated
05	Interior Stay/Away.	If the system is armed and a Delay zone is NOT tripped during the Exit Delay time, this zone type will be bypassed. If the [*][1] command is used to activate all Stay/Away type zones, this zone will have the standard Exit Delay. Once armed, this zone will act like an Interior zone [04].
06	Delay Stay/Away	If the system is armed and a Delay zone is NOT tripped during the Exit Delay time, this zone type will be bypassed. If the [*][1] command is used to activate all Stay/Away type zones, this zone will have the standard Exit Delay. Once armed, this zone will follow the Entry Delay time for Entry Delay 1 when tripped.
07	Delayed 24-hr Fire (Hardwired)	Operates the same as the standard Fire zone, except the alarm memory and transmission by the communicator is delayed by 30 seconds. If the alarm is acknowledged by pressing any key within 30 seconds, the bells will silence and the transmission will be aborted. If the alarm has been acknowledged, and the smoke detector has not been restored to normal, the bell output will activate after 90 seconds. The user then has another 30 second delay before the bell output latches and communications is activated. A code is then required to silence the bell output. NOTE: The Fire Delay will be terminated if a 2nd Fire zone is tripped or if the [F] key is pressed during a delay. NOTE: This zone type should not be used for Commercial Fire applications.
08	Standard 24-hr Fire (Hardwired)	On alarm, the bell output will sound to indicate that the fire loop has been activated. If enabled, the communicator will immediately transmit the alarm to the monitoring station. NOTE: DO NOT change the Zone attributes of Fire type zones from the default settings.
09	24-hr Supervisory	This zone is active at all times and will report an alarm at all times. The Supervision options (NC, EOL, DEOL, ZD) do not affect the functionality of the zone. The restored state of this zone type is 5.6KΩ, the Alarm state is short and the Trouble state is open. Can be used with the LINKS module as a LINKS Supervision zone. NOTE: This zone type must not be used for wireless zones.
10	24-hr Supervisory Buzzer	This zone is active at all times and will report an alarm at all times. Once tripped, the keypad buzzer will sound until a valid access code is entered. NOTE: This zone type should not be used on a Keyswitch ONLY system.
11	24-hr Burglary	This zone is active at all times and will report an alarm if the panel is armed or disarmed. This zone will sound the bell for the length of Bell Time-out if the Audible attribute is enabled.
12	24-hr Holdup	Similar to 24-hr Burglary except for System Event output type, SIA identifier and zone attribute.
13	24-hr Gas	Similar to 24-hr Burglary except for System Event output type, SIA identifier and zone attribute
14	24-hr Heat	Similar to 24-hr Burglary except for System Event output type, SIA identifier and zone attribute.
15	24-hr Medical	Similar to 24-hr Burglary except for System Event output type, SIA identifier and zone attribute.
16	24-hr Panic	Similar to 24-hr Burglary except for System Event output type, SIA identifier and zone attribute.
17	24-hr Emergency	Similar to 24-hr Burglary except for System Event output type, SIA identifier and zone attribute.
18	24-hr Sprinkler	Similar to 24-hr Burglary except for System Event output type, SIA identifier and zone attribute.
19	24-hr Water	Similar to 24-hr Burglary except for System Event output type, SIA identifier and zone attribute.
20	24-hr Freeze	Similar to 24-hr Burglary except for System Event output type, SIA identifier and zone attribute.
21	24-hr Latching Tamper	This zone type, when violated, will cause arming of the system to be inhibited until the valid Installer Code is entered. If this zone type is violated, the Installer Code must be entered ([*][8] Installers Code) before the system can be armed.
22	Momentary Keyswitch Arm	A keyswitch module may be connected to the zone programmed as Momentary Keyswitch arm. Momentary activation of this zone to the alarm state will alternatively arm and disarm the system and silence alarms.
23	Maintained Keyswitch Arm	A keyswitch module may be connected to the zone programmed as Maintained Keyswitch arm. In the restored state, the panel is disarmed. Only the violation of this zone type to the alarm state will make the panel arm.
24	LINKS Answer	Provides the LINKS1000 with a forced answer for downloading. The Restored state of this zone type is 5.6KΩ, and the open state causes the panel to answer. See the LINKS1000 <i>Installation Manual</i> for wiring instructions. When the zone is violated, the panel will seize the telephone line. NOTE: This zone type must not be used for wireless zones.

[001]-[004] ZONE DEFINITIONS											
Option	Zone Type	Description									
25	Interior Delay Zone	The Interior Delay Zone is normally used with motion detectors and has a standard Exit Delay time. If the panel is armed, and a Delay zone is violated during the Exit Delay (or the Away function key is used), the Interior Delay Zone will be active at the end of the Exit Delay. This zone will cause an instant alarm when violated. This zone type will follow the Entry Delay time provided that a Delay zone is violated first. If the panel is armed, and a Delay zone is NOT violated during the Exit Delay (or the Stay function key is used, or [*][9] armed), a violation of this zone type will initiate Entry Delay 1.									
26	24-hr Non-Alarm	These zones are active at all times but do not cause an alarm, and do not show up in alarm memory. Zone Attributes such as Zone Bypassing and Door Chime affect the functionality of this zone. A 24-hr Non-alarm zone may be used for Zone Follower automation applications. NOTE: This zone type will be active in Walk Test. Tamper and Faults. Zones programmed as 24-hr Non-alarm type will not cause alarms. NOTE: Alarms on this zone will not initiate Downlook.									
27	Delayed 24-hr Water-flow	These zones will follow the waterflow Delay Timer. When a delayed waterflow zone is violated, the waterflow timer will start, (any subsequent delayed waterflow zones that become active do not reset or abort this timer). If there are still delayed waterflow zones open when the waterflow timer expires, the panel will go into alarm and communicate the event(s) regardless of the armed state.									
28	Instant 24-hr Water-flow	A waterflow alarm is a Fire alarm. The Fire related bells and Aux functions are activated. This Zone type functions similar to Type 27 (Delayed 24-hr waterflow), but does not follow the Waterflow Delay Timer. When this zone is violated, it will immediately go into alarm. This zone type always uses a single EOL configuration.									
29	Auto Verified Fire Zone	This zone ensures that an alarm condition persists by resetting a tripped sensor in a fire zone and confirming that the sensor has remained tripped or is waiting for the sensor to re-trip within a set period of time (e.g., cycling power to a smoke detector to ensure the condition persists when power is restored). The alarm sequence for the zone is indicated below: <table border="0" style="width: 100%;"> <tr> <td style="padding-left: 20px;">Step #1</td> <td style="padding-left: 20px;">Duration 20 Seconds</td> <td style="padding-left: 20px;">Sensor Reset</td> </tr> <tr> <td style="padding-left: 20px;">Step #2</td> <td style="padding-left: 20px;">Duration 10 Seconds</td> <td style="padding-left: 20px;">Settle Time (Power-up)</td> </tr> <tr> <td style="padding-left: 20px;">Step #3</td> <td style="padding-left: 20px;">Duration 60 Seconds</td> <td style="padding-left: 20px;">Check for Verified Alarm</td> </tr> </table> NOTE: If another Fire device detects Fire during the Auto Verify or Delay sequence, the sequence is terminated and alarms are immediately generated for all pending zones. This applies to all other Fire zones on the system regardless of the partition assignments (i.e., two fire alarms anywhere on the system will cancel all pending fire delays and create immediate alarms).	Step #1	Duration 20 Seconds	Sensor Reset	Step #2	Duration 10 Seconds	Settle Time (Power-up)	Step #3	Duration 60 Seconds	Check for Verified Alarm
Step #1	Duration 20 Seconds	Sensor Reset									
Step #2	Duration 10 Seconds	Settle Time (Power-up)									
Step #3	Duration 60 Seconds	Check for Verified Alarm									
30	Fire Supervisory Zone	When this zone is violated, the system turns on the keypad buzzer, and communicates the supervisory alarm condition to the monitoring station. The buzzer will not follow the Bell Time-out. To silence the buzzer, a valid access code must be entered. NOTE: The fire supervisory alarm is not affected by the waterflow silence inhibit option described in [018], Option 4, Pg 32									
31	Day Zone	A zone programmed as this type has different characteristics in the armed and disarmed state. In the disarmed state, violating this zone will sound the keypad buzzer but will not log or report the event. In the armed state, violating this zone will sound the bell and communicate the event.									
87	Delayed 24-hr Fire (Wireless)	Used only with wireless smoke detectors. Functions same as Zone Type [07].									
88	Standard 24-hr Fire (Wireless)	Used only with wireless smoke detectors. Functions same as Zone Type [08].									

[005] - System Times

This section has 9 sub-sections, 1 for each of the 8 partitions, and 1 for the Bell time-out. A 2-digit entry is required to access these sub-sections.

NOTE: Entry of 000 in these sections will result in a 255-second time.

Sub-Sections 1-8 each require three 3-digit entries.

[01] - [08] Entry Delay 1, Entry Delay 2, and Exit Delay per partition.

- **Entry Delay 1:** 030-255 Seconds

This value determines the Entry delay time for Delay 1 type zones. The default Entry Delay 1 time is 30 seconds.

- **Entry Delay 2:** 030-255 Seconds

This value determines the Entry delay time for Delay 2 type zones. The default Entry Delay 2 time is 30 seconds.

- **Exit Delay:** 045-255 Seconds

This value determines the Exit delay time when arming the system. The default Exit Delay time is 60 seconds.

NOTE: The Exit Delay must not exceed 255 seconds. The minimum possible entry is 45 seconds.

NOTE: If the Exit Delay is silent (Section 014, Option 6 or Stay Function Key Arming) the Exit Delay will be twice the programmed value (060-510 seconds).

[09] Bell Time-out: 001-255 Minutes

The Bell Time-out for all 8 partitions will be the same.

The siren will silence after the number of minutes programmed for the **Bell Time-out** value has passed. The default Bell Time-out is 4 minutes

The panel supervises the Bell output. If an open condition is detected, the panel will immediately indicate a Trouble condition by beeping the keypad twice every 10 seconds to alert the owner to the problem. The panel can send a **Bell Circuit Trouble** and **Trouble Restoral** reporting codes to indicate the situation (see section 5.6, 'Communicator Programming' PWS Sect 6).

If the **Temporal Three Fire Signal** option is enabled, all Fire signals will follow the Temporal Three Pattern as described in NFPA 72. If turned OFF all Fire signals will sound a one second on, one second off cadence.

If **Fire Bell Continuous** is enabled, the alarm output will sound until a code is entered. If disabled, the alarm will sound until a code is entered or the bell time-out has expired.

NOTE: Only fire zones will follow the Temporal Three Fire Signal.

.....	Bell Time-out	Section [005]
.....	Bell Circuit Trouble Reporting Code	Section [349]
.....	Bell Circuit Trouble Restoral Reporting Code	Section [350]
.....	Temporal Three Fire Signal	
.....	Enable/Disable	Section [013], Option [8]
.....	Fire Bell Continuous	Section [014], Option [8]

[006]-[008] Special Access Codes

These sections require 4 or 6 digits to be entered.

[006] - Installer Code

 Installer Lockout Enable Section [990]
 Installer Lockout Disable Section [991]

[007] - Master Code

[008] - Maintenance Code

This is an Arm/Disarm only code. It can not be used to bypass, activate [*][7] outputs, program other user codes or enter the [*][6] menu. It can access and arm through the Escort5580(TC). Openings or Closings using this code report as a Special Opening/Closing and will log to the event buffer as 'Maintenance Code'.

[009]-[011] Programmable Output Options

Programmable outputs are programmed with a two digit code indicated in the table below. Programmable outputs are available on the following devices:

- PGM 1, PGM 2, PGM 3, and PGM 4 on the PC5020 main board

- 8 low current outputs available with the PC5208 output module
- 4 high current outputs available with the PC5204 power supply/output module
- Section [009] is used to program the PGM outputs on the PC5020.
- The first two entries of Section [010] are used to program the last two outputs on the PC5020, and the first two on the PC5208.
- Section [010] is used to program the PGM outputs on the PC5208.
- Section [011] is used to program the PGM outputs on the PC5204.

Programming any of the outputs is a three step process:
 1. Select an option from the list below for the PGM output.
 2. Select the output attributes for the PGM output.
 3. Select the partitions on which the PGM output will operate.

The following is a list of the programmable output options and attributes.

 PGM Attribute Programming Section [501]-[564]

[009] - [011] PROGRAMMABLE OUTPUT OPTIONS										
Option	Output	Description								
01	Burglary and Fire Bell Follower	This output will activate when the Bell output is active and will turn off when the alarm output is silenced. If the alarm output is pulsing, the PGM output will pulse as well. This PGM output will follow: <ul style="list-style-type: none"> • Fire Pre-alerts • Temporal Three Fire Signal (if enabled) • All Burglary and Fire Alarms by partition • Bell Time-out This output will NOT follow Bell Squawks of any kind. The Main Bell will still activate for all alarms; the PGM output will only activate for alarms for the partition it is assigned to. NOTE: The Fire Bell has precedence over Burglary. If a fire alarm occurs on partition X, and partition Y already has a Burglary Alarm active ('Burg' PGM active on partition two), the Fire and Burg output on partition Y will pulse ('Fire' PGM) with the Main Bell. Silent alarms will be audible if either partition is in an audible alarm condition.								
02	Not Used	For Future Use								
03	Sensor Reset	This output will normally be active. This option is used to reset power for latching smoke detectors. The output will deactivate for five seconds when the [*] [7] [2] command is entered (see section [*] [7] Command Output Functions'). The keypad buzzer will not sound for the five second period. Refer to the Control Panel Wiring Diagram in this manual for wiring instructions. NOTE: Only ONE of options [03] Sensor Reset and [20] [*] [7] [2] Command Output Option [2] may be programmed on the same system.								
04	Two-Wire Smoke Reset (PGM2 only)	Allows 2-wire smoke detectors to be connected; refer to the wiring diagram on page iv, [*][7][2] to reset.								
05	System Armed Status	The output will activate when the partition or system is armed and deactivate when disarmed. If this output is assigned to both partitions, all partitions must be armed for the output to activate.								
06	Ready To Arm	The output will activate when the partition or System is ready to arm (all non-force armable zones on the system are restored). The output will deactivate when an access code is entered to arm the system and the Exit Delay begins.								
07	Keypad Buzzer Follow	This output will activate when any of the following events occurs and will remain active for as long as the keypad buzzer is active: Door Chime, Entry Delay, Audible Exit Delay, Auto-arm Prealert and 24-hr Supervisory Buzzer Zone								
08	Courtesy Pulse	This option provides an output which activates for the entry and exit times, plus 2 minutes. It can be used to turn on a courtesy light near the exit door for the duration of the entry / exit times. If more than one courtesy pulse output is required, they all must be programmed for global operation (PGM attributes 1 and 2 enabled).								
09	System Trouble	The output will activate when any of the selected Trouble conditions are present. It will deactivate when all the selected Trouble conditions are cleared. The PGM attributes for this option, programmed in Sections [141] to [142], differ from the standard selection of attributes normally programmed in sections [501] to [514]. Program which Trouble conditions will activate the output by selecting some or all of the following attributes: <table border="0" style="width: 100%;"> <tr> <td>Bit [1] Service Required*</td> <td>Bit [5] Fire Trouble / Zone Fault</td> </tr> <tr> <td>Bit [2] AC Failure</td> <td>Bit [6] Zone Tamper</td> </tr> <tr> <td>Bit [3] Telephone Line Trouble</td> <td>Bit [7] Zone Low Battery</td> </tr> <tr> <td>Bit [4] Failure to Communicate</td> <td>Bit [8] Loss of Clock</td> </tr> </table> *Battery, bell, general Trouble, general tamper, general supervisory	Bit [1] Service Required*	Bit [5] Fire Trouble / Zone Fault	Bit [2] AC Failure	Bit [6] Zone Tamper	Bit [3] Telephone Line Trouble	Bit [7] Zone Low Battery	Bit [4] Failure to Communicate	Bit [8] Loss of Clock
Bit [1] Service Required*	Bit [5] Fire Trouble / Zone Fault									
Bit [2] AC Failure	Bit [6] Zone Tamper									
Bit [3] Telephone Line Trouble	Bit [7] Zone Low Battery									
Bit [4] Failure to Communicate	Bit [8] Loss of Clock									

[009] - [011] PROGRAMMABLE OUTPUT OPTIONS		
Option	Output	Description
10	Latched System Event (Strobe)	<p>This output will activate when any of the selected system events (alarms) occur on the system. In the armed state, the output will deactivate only once the system is disarmed. This output will activate when the programmed events occur on any partition.</p> <p>If an alarm activates this output in the disarmed state, the output will deactivate if a user enters a valid access code while the Bell Time-out is counting down. The output will also deactivate if someone arms the system after the Bell Time-out has expired. This output can be used to indicate that an alarm has occurred before entering the premises.</p> <p>The PGM attributes for this option, programmed in Sections [501] to [514], differ from the standard selection of attributes normally programmed. Program the events that will activate the output by selecting some or all of the following attributes:</p> <ul style="list-style-type: none"> Bit [1] Burglary (Delay, Instant, Interior, Stay/Away and 24-hr Burglary Zones) Bit [2] Fire (Fire Keys, Fire Zones) Bit [3] Panic (Panic Keys and Panic Zones) Bit [4] Medical (Auxiliary Keys, Medical and Emergency Zones) Bit [5] Supervisory (Supervisory, Freezer and Water Zones) Bit [6] Priority (Gas, Heat, Sprinkler and 24-hr Latching Zones) Bit [7] Holdup (Holdup Zones) Bit [8] Output follows pulse timer (Section [170]) <p>This output will activate for silent and audible alarms or medical conditions only. It will not activate during pre-alert or delays.</p>
11	System Tamper	This output will activate when any Tamper condition is present and will deactivate when all Tamper conditions are cleared. These tampers include zone tampers (DEOL), 24-hr latching tamper zone type, module and keypad tampers.
12	TLM and Alarm	This output will activate when a telephone line fault condition is present AND an alarm occurs. The output will remain active until an access code is entered to disarm any partition. The output will activate for all audible and silent alarms (except duress) if a TLM Trouble is present. If an alarm activates this output in the disarmed state, it will deactivate when the system is armed or the telephone line is restored.
13	Kissoff	The PGM output will activate for two seconds after the panel receives the kissoff from the central station.
14	Ground Start	The output will activate for two seconds before the panel attempts dialing to obtain a dial tone on ground start telephone equipment. Two 2-second pauses must be inserted at the beginning of the telephone number when using this option.
15	Remote Operation	This output can be activated and deactivated remotely on command from DLS software.
16	LINKS 1000 Support (PGM1 only)	This option configures the PGM1 terminal for operation with the LINKS1000 cellular alarm communicator.
17	Away Armed Status	This output will activate when the system is armed with the Stay/Away zones activated.
18	Stay Armed Status	The output will activate when the system is armed with the Stay/Away zones bypassed.
19	Command Output #1.	<p>This output is activated by entering the [*][7][1] command. The configuration of the corresponding attributes determines how this PGM type will activate.</p> <p>Command Outputs 1-4 are user-initiated by entering [*] [7] [1-4] at any keypad. When any output is activated, three acknowledgment beeps are sounded.</p> <p>Refer to Section [501] and [551] for more information on Attributes.</p> <p>NOTE: If there are multiple outputs programmed with the same output type, the output options must be the same.</p>
20	Command Output #2.	<p>This output is activated by entering the [*][7][2] command. The configuration of the corresponding attributes determines how this PGM type will activate.</p> <p>NOTE: Only ONE of options [03] Sensor Reset and [20] [*] [7] [2] Command Output Option #2 may be programmed on the same system.</p>
21	Command Output #3.	This output is activated by entering the [*][7][3] command. The configuration of the corresponding attributes determines how this PGM type will activate.
22	Command Output #4.	This output is activated by entering the [*][7][4] command. The configuration of the corresponding attributes determines how this PGM type will activate.
23	Silent 24-hr Input (PGM2 Only).	With this input the keypad will not indicate an alarm, the bell will remain silent but the signal will be sent to the central station. This input does not follow Swinger Shutdown. A 2.2KΩ EOL resistor is required for this input (to Aux+). If a short or open occurs, an alarm is generated.
24	Audible 24-hr (PGM 2 only).	LCD keypads will show that the system is in alarm, and the bell will sound for the duration of BTO. The signal will also be sent to the central station. This input does not follow Swinger Shutdown. A 2.2KΩ EOL resistor is required for this input (to Aux+). If a short or open occurs, an alarm is generated.
25	Delay Fire and Burglar Output.	<p>This programmable output type operates the same as the Fire and Burglary Output (Type 01), except that it follows the Transmission Delay Timer found in Section [370]. If a zone is violated that has the TX Delay attribute enabled (bit 7), the bell and regular Fire and Burg PGMs will activate. At the end of the Transmission Delay, this new PGM type will activate.</p> <p>This feature is used for door sirens; if a false alarm occurs on a panel, the end user could silence it before any external sirens are activated.</p> <p>NOTE: If a zone is violated that causes an alarm that does not have Tx Delay enabled, these outputs will activate immediately.</p> <p>This output is partitionable, and will follow transmission delay by partition.</p> <p>This output will activate for Audible Exit Fault</p>

[012] - Keypad Lockout Options

The panel can be programmed to 'lockout' keypads if a series of incorrect access code entries is made. After the **Number of Invalid Codes Before Lockout** has been reached the panel will lock out the keypad for the **Lockout Duration** and log the event to the event buffer. For the duration of the lockout the panel will sound an error tone when any key is pressed. To program 'Number of Invalid Codes Before Lockout':

Enter a number from 000 to 255 to determine the number of invalid master, duress, user or installer access code entries to reach keypad lockout. When keypad lockout occurs, the system is rendered inoperative via keypad for the programmed duration. When any keys are pressed, an error tone will sound.

To program 'Lockout Duration', enter a time from 000 to 255 minutes to determine the length of time before lockout resets and the keypad can once again be used.

NOTE: If lockout is not reached within the hour roll-over, the number of invalid attempts is reset to 0.

NOTE: FAP keys are still active during Keypad Lockout.

NOTE: Keypad Lockout is a Global Feature.

To disable Keypad Lockout enter the **Number of Invalid Codes Before Lockout** as (000).

NOTE: If Keypad Lockout is active, the panel cannot be armed or disarmed with a keyswitch.

[013] First System Option Codes

Option	Definition	On/Off	Description
1	Zone Loop Type	ON	Normally Closed Loops. All zones are wired as normally closed circuits with returns connected to a COM terminal. The end of line resistor is not required. An alarm will be generated when the circuit is opened.
		OFF	End of Line Resistors. All zones must be wired with an end of line (EOL) resistor configuration, determined by Option 2 in this system. NOTE: The valid EOL value is 5600 Ohms (5.6KΩ).
2	End of Line Option	ON	Double End-of-Line Resistors. All zones will use Double-End-of-Line resistors, except Standard Fire, Delayed Fire, Supervisory, and LINKS Answer zone types. These zones must be connected using the EOL resistor. Double EOL resistors enable detection of zone faults and tampers. See wiring diagram.
		OFF	Single End-of-Line Resistors. All zones must have a 5.6KΩ resistor across them. If the zone is shorted or open, it will be in the violated state.
3	Trouble Display	ON	Panel Shows all Troubles While Armed. The panel will illuminate the Trouble LED when any troubles are present on the system in both the armed and disarmed state.
		OFF	Panel Shows Only Fire Troubles While Armed. The panel will illuminate the Trouble LED for all troubles while disarmed, but will only illuminate the LED for Fire Troubles while armed. NOTE: This option must be OFF if PKP-LCD keypads older than version 2.00 are used.
4	Tampers/Faults Display	ON	Tampers and Faults Do Not Show as Open. The panel will not illuminate the respective zone LED if the zone is in the Tamper or Fault states, only the Trouble LED will be on.
		OFF	Tampers and Faults Show as Open. The panel will illuminate the respective Zone LED if the zone is in the Tamper or Fault states. The Trouble LED will also light.
5	Auto-arm Schedule Programming	ON	Auto-arm Schedule in [*][6]. The Auto-arm schedules (Sect [181] - [188]) are accessible via [*][6] as well as Installer Programming. NOTE: Refer to 'Setting Date and Time' in the User's Guide
		OFF	Auto-arm Schedule in Installer's Programming Only. The Auto-arm Schedules (Sect [181] - [188]) are only accessible via Installer's Programming. NOTE: This toggle controls access for all eight partitions
6	Audible Exit Fault	ON	Audible Exit Fault is Enabled. To prevent false alarms, use the built-in feature Audible Exit Fault . If a delay zone is violated within 4 seconds after the Exit Delay has expired, the panel will sound the Entry Delay warning through the keypad and siren alerting the customer that an improper exit was made. If the panel is disarmed within the Entry Delay no signal is sent. If not, the panel will continue to sound the alarm and send a signal to the central station.
		OFF	Audible Exit Fault is Disabled. NOTE: For [*][9] arming, if Audible Exit Fault is enabled a violated zone will begin entry delay as per Audible Exit Fault functionality. If this option is disabled, a violated delay zone at the end of the Exit Delay will cause an instant alarm.
7	Event Buffer Follows Swinger Shutdown	ON	Event Buffer Follows Swinger Shutdown. Once an event reaches its Swinger Shutdown limit programmed in Section [370], it will no longer log events to the event buffer until the Swinger Shutdown is reset. This avoids filling the event buffer with useless events and prevents the panel from overwriting the entire buffer if a problem exists.
		OFF	Event Buffer Logs Events past Swinger Shutdown.
8	Fire Signaling	ON	Temporal Three Fire Signal. To comply with NFPA 72, all fire bells will sound in the Temporal Three pattern as described in the NFPA standard if this option is enabled. This cadence is as follows: (500ms ON, 500ms OFF, 500ms ON, 500ms OFF, 500ms ON, 1.5 sec. OFF).
		OFF	Standard Pulsed Fire Signal. All fire bells will sound with the standard 1 second on/1 second off fire bell cadence.

[014] - SECOND SYSTEM OPTION CODES

Option	Definition	On/Off	Description
1	Bell Squawk	ON	Arm / Disarm Bell Squawk Enabled. The bell output will sound a single squawk when armed in any manner, including Auto-arm, and a double squawk upon disarming the system. If there are alarms in memory, the bell will emit a series of three squawk pairs to indicate the alarm memory. NOTE: If you enable the Bell Squawk on Arming/Disarming, the bell will sound arm/disarm bell squawks for all access codes, regardless of the programming for attribute [7] (see section '[*] [5] Programming Access Codes')
		OFF	Arm / Disarm Bell Squawk Disabled. The bell output will not squawk when the system is armed or disarmed in any manner.

Option	Definition	On/Off	Description
2	Bell During Auto-arm	ON	Bell Squawk During Auto-arm Enabled. The bell output will sound a single squawk every 10 seconds during the Auto-arm Pre-alert time. This will inform anyone on the premises that the system is being armed.
		OFF	Bell Squawk During Auto-arm Disabled. The bell output will not be activated during the Auto-arm warning time
3	Bell Squawk On Exit	ON	Bell Squawk On Exit Delay. The bell output will squawk once per second during the Exit Delay time. The bell will also sound 3 squawks per second for the final 10 seconds <i>NOTE: If the panel is armed using the Stay function key, or by entering [*] [9] [Access Code], there will be no bell squawks during entry and Exit Delays, except for the arm/dis-arm bell squawks.</i>
		OFF	No Bell Squawk On Exit Delay. <i>NOTE: This audible option does not apply to Stay and No Entry arming modes.</i>
4	Bell Squawk On Entry	ON	Bell Squawk On Entry Delay. The bell output will pulse with the same timing as the buzzer during the Entry Delay time. The bell will also sound 3 squawks per second for the final 10 seconds if Option 6 in this section is enabled. <i>NOTE: This feature must not be used with two or more partitions.</i>
		OFF	No Bell Squawk On Entry Delay
5	Bell Squawk on Trouble	ON	Bell Squawks on Trouble. When there is a Trouble condition annunciated on the system keypads, the bell will squawk 2 times every 10 seconds (as per the keypad buzzer). The bell will be silenced when the keypad beeps are silenced (any key pressed on keypad).
		OFF	No Bell Squawks on Trouble.
6	Audible Exit Beeps	ON	Audible Exit With Urgency. The keypad will sound a pulsing tone (once per second) during the Exit Delay. For the last 10 seconds of the Exit Delay, the keypad and bell / siren (if enabled) will sound a different tone (3 tones per second) to warn that the Exit Delay is about to expire.
		OFF	Silent Exit Delay. The keypad will not sound during the Exit Delay.
7	Exit Delay Termination	ON	Exit Delay Termination Enabled. The Exit Delay will be terminated once a Delay 1 Zone for the entry/exit door or area is restored. All audible options associated with the Exit Delay will be silenced when the Exit Delay is terminated. Force-armable Delay 1 type zones will also terminate the Exit Delay.
		OFF	Exit Delay Termination Disabled. The Exit Delay timer will continue to count even after the Delay Zone for the entry/exit door or area is restored. All audible options associated with the Exit Delay will function until the time programmed for the Exit Delay has elapsed.
8	Fire Bell Time-out	ON	Fire Bell is Continuous. The bell output will sound for all Fire type alarms until an access code is entered to silence the alarm or disarm the system regardless of the time programmed for bell Time-out in Section [005].
		OFF	Fire Bell Follows Time-out. The bell output will sound for all Fire type alarms for the duration of Bell Time-out or until an access code is entered.

[015] - THIRD SYSTEM OPTION CODES

Option	Definition	On/Off	Description
1	[F] Key	ON	[F] Key Enabled. Pressing and holding the [F] key for 2 seconds will generate a Fire alarm. The keypad will sound a set of 3 beeps to acknowledge the valid alarm and the bell or siren will pulse one second on, one second off if option 8 of Section [013] is disabled (Standard Fire option). If Fire Bell is Continuous (Section [14], Option 8) is selected the alarm output will sound until a code is entered; otherwise it will sound until a code is entered or the alarm output times out. The Fire, Auxiliary, Panic keys will operate even if Keypad Blanking and Keypad Lockout are active (see Section 5.3 'Basic Programming PWS Sect 3' [012]).
		OFF	[F] Key Disabled. The [F] key will not sound or report an alarm when pressed.
2	[P] Key Annunciation	ON	[P] Key Audible. When a valid [P] key alarm is generated, the keypad buzzer will sound a series of 3 beeps to acknowledge the alarm. The bell or siren will also sound for the length of Bell Time-out. <i>NOTE: The Fire, Auxiliary, Panic keys will operate even if Keypad Blanking and Keypad Lockout are active (See Section 5.3 'Basic Programming PWS Sect 3' [012]).</i>
		OFF	[P] Key Silent. When a valid [P] key alarm is generated: the Keypad buzzer and the bell output will remain silent; the alarm transmission will still be transmitted if programmed.
3	Quick Exit	ON	Quick Exit Enabled. When the system is armed, users may enter the [*][0] command to allow a single Delay 1 or Delay 2 Zone to be activated so they may leave the premises. Only one Delay zone may be activated. Additional activity on another Delay zone will initiate its respective alarm sequence. If the Delay zone is still open two minutes after the [*][0] command is entered, the Entry Delay will be initiated. If armed in the Stay mode, the automatic bypass on Stay/Away zones will not be removed.
		OFF	Quick Exit Disabled.
4	Quick Arming/Function Key	ON	Quick Arming Enabled/Function Keys Do Not Require Code. [*][0] arming and Stay/Away function keys may be used to arm the system without the entry of a valid access code. All other function keys may also be used without the entry of an access code.
		OFF	Quick Arming Disabled/Function Keys Require Code. [*][0] arming is not permitted, and all function keys require the entry of an access code to activate (including Stay/Away keys). <i>NOTE: This option must be on if less than version 3.00 of the PC5132 is used.</i>
5	Bypass Access Code	ON	Access Code Required to Bypass Zones. After entering the [*][1] Bypass Zones command, an access code must be entered before zones may be bypassed.
		OFF	Access Code Not Required to Bypass Zones. Enter the [*][1] Bypass Zones Command to bypass zones. Note: This option is supplemental to Option 4.
6	Master Code	ON	Master Code Not User Changeable. The Master Code (Access Code 40) may not be changed by the user, and may only be programmed in the Installers Programming mode.
		OFF	Master Code User-Changeable. The Master Code (#40) may be programmed by the user using the [*] [5] [Master Code] command. The Master Code may also be programmed in the Installer Programming mode.

Option	Definition	On/Off	Description
7	Telephone Line Monitor	ON	Telephone Line Monitor enabled. The TLM function will be active and the system will indicate a Trouble #3 condition when using the [*][2] View Trouble Conditions command.
		OFF	Telephone Line Monitor disabled. The TLM function will be shut off and telephone line troubles will not be indicated by the system.
8	Telephone Line Monitor Audible Trouble	ON	TLM Audible When Armed. When the system is disarmed, a Telephone Line Monitor Trouble will generate a Trouble indication as described above. If the system is armed, a Telephone Line Monitor Trouble will generate an audible alarm on the bell or siren for the duration programmed for Bell Time-out or until an access code is entered to disarm.
		OFF	TLM Trouble Only. A Telephone Line Trouble will generate a Trouble indication, the Trouble LED will come ON, and the keypad sounder will beep until a key is pressed.

[016] - FOURTH SYSTEM OPTION CODES

Option	Definition	On/Off	Description
1	AC Trouble Display	ON	AC Trouble Displayed. If AC power fails, the condition will be reported to the monitoring station and will be indicated as a Trouble condition on the system keypads.
		OFF	AC Trouble Not Displayed. If AC power fails, the condition will be reported, but the Trouble light will not be indicated on the system keypads. If [*][2] is entered to view the system troubles, Trouble #2 will still be displayed.
2	AC Trouble Flash	ON	Trouble Light Flashes if AC Fails. When AC power is lost from the system, the Trouble light will flash in the base Ready and Armed mode within 30 seconds after power is lost. When AC restores, the Trouble light will stop flashing within 30 seconds. If enabled, this option will override the AC display option.
		OFF	Trouble Light Does Not Flash on AC Fail.
3	Keypad Blanking	ON	Blank Keypad When Not Used. If no keys are pressed for 30 seconds, all keypad lights except backlighting (if enabled) will be shut OFF until the next keypress, Entry Delay, Audible Alarm or Keypad Buzzer condition. NOTE: Keypad function keys will still operate when the keypad is blank, unless the function key is programmed to require an access code.
		OFF	Keypad Always Active. The keypad lights will remain ON at all times.
4	Keypad Blanking Restore	ON	Access Code Required to remove Keypad Blanking. A valid access code must be entered before a blanked Keypad can be used
		OFF	Access Code Not Required. Pressing any key on a blanked keypad will remove the blanking.
5	Keypad Backlighting	ON	Keypad Backlighting is Enabled. All keypads on the system will have backlighting on all of the time.
		OFF	Keypad Backlighting is Disabled.
6	Power Save Mode	ON	Power Save Mode Enabled. If AC power fails, all keypad lights including backlighting will be shut OFF. The keypad lights will come back ON after a keypress, Entry Delay, Audible Alarm or Keypad Buzzer condition (except Door Chime). The keypad lights will return to the off state after 30 seconds of keypad inactivity.
		OFF	Power Save Mode Disabled.
7	Bypass Status Display	ON	Bypass Status Displayed While Armed. The Bypass status light will be ON if there are zones bypassed when the system is armed.
		OFF	Bypass Status Not Displayed While Armed. The Bypass light will be ON only while the system is disarmed to indicate that there are bypassed zones on the system. When the system is armed, the Bypass light will be OFF. NOTE: The Bypass status LED will be ON if there are Stay/Away zones auto-bypassed at the time of arming regardless of whether or not this option is enabled. This option only enables and disables manual bypass display.
8	Keypad Tamper	ON	Keypad Tamper are Enabled. All keypads containing Tamper switches will generate Tamper Alarms and Restorals (Sect 338). NOTE: Not used in North America; ensure that it is disabled.
		OFF	Keypad Tamper are Disabled. NOTE: If this option is used, all keypads should be properly installed and secured (Tamper restored) before enabling the option.

[017] - FIFTH SYSTEM OPTION CODES

Option	Definition	On/Off	Description
1	Wireless Key Disarming	ON	WLS Keys Do Not Use Access Codes. The panel will accept the disarm keycode from an unidentified wireless key, allowing arming/disarming without a code. NOTE: Wireless keys can only be assigned access codes when used with PC5132 (refer to the PC5132 Installation Manual for information on programming wireless keys.) NOTE: This option must be enabled when using a PC5132 v2.1 or earlier.
		OFF	NOTE: WLS Keys Uses Access Codes. The panel will NOT accept the disarm keycode from an unidentified wireless key. An Access code must be associated with a WLS key for proper operation (refer to the PC5132 manual for information on programming wireless keys). NOTE: This option must be ON when using a PC5132 older than v3.00.
2	RF Jam Event Log Options	ON	RF Jam Log After 5 Minutes. The RF Jam Trouble will not log to the event buffer until the 5- minute delay has elapsed.
		OFF	RF Jam Log After 30 Seconds. The RF Jam Trouble will log to the event buffer after the initial 30 second delay has elapsed.

Option	Definition	On/Off	Description
3	Audible RF Jam Trouble Beeps	ON	Audible RF Jam Trouble Beeps
		OFF	An RF Jam will not sound Trouble Beeps
4	Double Hit	ON	Double Hit Enabled. Two alarms from the same zone within the Cross Zone Timer Duration will cause the Police Code or Cross Zone to be logged and transmitted.
		OFF	Double Hit Disabled. Two alarms from the same zone will not cause the Police Code or Cross Zone to be logged and transmitted. Two different zones must be in alarm to transmit the Police Code or verify the Cross Zone. NOTE: This feature only applies to zones defined as Interior, Interior Delay, Interior Stay/Away, or Delay Stay/Away (PIR Zones). <ul style="list-style-type: none"> This is a flexible extension of the existing Police Code. This feature is directly affected by the Cross Zone Timer.
5	Late To Close	ON	Late to Close Enabled. The panel will communicate and log a Late to Close event at the time programmed for Auto-arm for each partition. This system toggle controls if the Late to Close reporting code is sent at the end of the Auto-arm/Postpone Pre-alert. Use this feature for installations that require an audible warning if the panel is not armed by a certain time of day, if you do not wish to have it arm. Anyone who hears this warning should manually arm, or contact the central station to let them know why the panel has not been armed by the programmed time.
		OFF	Late to Close Disabled. The panel will neither communicate nor log a Late to Close event at the time programmed for Auto-arm for each partition. NOTE: If the Auto-arm toggle option is disabled, the Auto-arm Pre-alert will still occur if there is a time programmed for that day if this option is enabled. This option does not directly affect the functionality of Auto-arm. If Late to Close is enabled and Auto-arming is not, LCD Keypads will still display 'System Arming in Progress' during the Late to Close Pre-alert.
6	Daylight Savings Time	ON	Daylight Savings Time Enabled. At 2 a.m. on the first Sunday in April, the panel clock will be set forward one hour to 3 a.m. At 2 a.m. on the last Sunday in October, the panel clock will be set back one hour to 1 a.m. Events programmed to occur between 2:00 and 3:00 a.m. will not occur on the first Sunday in April. Events programmed to occur between 1:00 and 2:00 a.m. will occur twice on the last Sunday in October.
		OFF	Daylight Savings Time Disabled. The panel will make no automatic time adjustments for Daylight Savings Time. NOTE: Auto-arm and test transmissions should not be attempted between 0200 and 0300 hours, as they will be missed on the first Sunday in April. Events programmed to occur between 0100 and 0200 will occur twice on the last Sunday in October.
7	Periodic Camera Test	ON	Periodic Camera Test Enabled. The panel will test all active cameras on the PC5108L every 30 minutes.
		OFF	Periodic Camera Test Disabled. If this option is OFF, the panel will only test all active cameras on the PC5108L upon exiting Installer Programming, or during System Test NOTE: The active camera monitor is selected using function key Option 22. Refer to the PC5108L Installation Manual for function key use.
8	Bell Squawk on Away Key Arming	ON	Squawk on Away Key Arming/Disarming Only. Bell Squawks will only be heard on Away arming, as well as upon disarming after being armed in the Away mode with the Away key. NOTE: This option controls when Bell Squawks are annunciated. This feature is to prevent the bell from being activated when arming from inside the premises.
		OFF	Bell Squawk on all Arming/Disarming. Bell Squawks will be heard on all types of arming and disarming. NOTE: This option follows the Bell Squawk on Arming/Disarming and Bell Squawk Attribute features. This option is off at default.

[018] - SIXTH SYSTEM OPTION CODES

Option	Definition	On/Off	Description
1	Periodic Test Transmission Exception	ON	Periodic Test Transmission Exception Enabled. With this feature enabled, the panel will not send a test transmission if there has been a transmission sent to the receiver within the programmed time. Test Transmission Exception allows any communicable event to reset the test transmission cycle, reducing the number of communications events sent to the central station, For example: 02/10 - Opening 02/11 - Closing 1 Days 02/14 - Test Transmission 3 Days < 7 Days 02/16 - Opening 2 Days between 02/18 - Closing 2 Days Test 02/21 - Test Transmission 3 Days < Transmissions If an event is communicated, the Test Tx counter is reset, ensuring that a Test Tx event will not occur for an entire cycle from that point, instead of from the last test transmission sent. An example is given below with test transmission set for every 3 days. This ensures that a transmission is sent every 3 days to test communications; however, if an event has already been sent in the last 3 days, a test transmission is not required. If the event was sent via land line, the land line Test Tx cycle is reset. If the event is sent via LINKS1000, the LINKS Test Tx cycle is reset. NOTE: In order for an event to reset the Test Tx cycle, a kissoff must be received from the receiver. NOTE: The test transmission cycle will not be reset when events are transmitted using the Pager (05) or Residential Dial (06) formats.
		OFF	Periodic Test Transmission Exception Disabled. The panel will always send a test transmission at the programmed interval and time. This option is OFF at default.

Option	Definition	On/Off	Description
2	Verbal Door Chime	ON	<p>Verbal Door Chime Is Enabled. The system will verbally announce the zone (or programmed label) when it is violated if Door Chime is programmed.</p> <p>This feature is available when Escort5580(TC) v3.00, and the PC5936 v1.00 are used. This feature enables the Door Chime to verbally announce the zone that has been violated instead of a series of beeps. If the Verbal Chime feature is enabled, whenever a zone with the Chime attribute enabled is violated, a series of beeps will sound and the system will verbally prompt 'Zone X'. When the zone is restored, the system will sound a series of beeps. For example, if a label is programmed for the above Zone, the system will verbally announce (after the beeps) 'South Bedroom Window'. See associated <i>Installation Manuals</i></p> <p>NOTE: Only beeps are announced on a zone restoral.</p>
		OFF	<p>Verbal Door Chime is Disabled. The system will only announce a series of beeps whenever a zone programmed for Chime is either violated or restored. This option is defaulted OFF.</p>
3	Verbal Alarm	ON	<p>Verbal Alarm Is Enabled. The system will verbally announce audible zone alarms via their zone number (or programmed label) in conjunction with the bell outputs.</p> <p>This feature is available when the Escort5580(TC) v3.00 and PC5936 v1.00 are used. This feature enables verbal announcement of alarm conditions on the system. When an audible non-fire zone goes into alarm with this feature enabled, the PC5020 will sound the alarm condition via the bell outputs, but every 15 seconds (as programmed in the Alarm Tone Period – Section [178]) it will silence the bell outputs and the PC5936 speakers will verbally announce the alarm condition 'Alarm Zone 4' or, if the label is programmed, 'Alarm South Bedroom Window'.</p> <p>When the zone is in alarm, the software automatically inserts the word 'Alarm' in front of the appropriate zone label.</p> <p>When an audible fire zone goes into alarm, the system automatically inserts the words 'Fire' and 'Alarm' in front of the appropriate zone label ('Fire Alarm Zone 4' or 'Fire Alarm South Bedroom Smoke').</p> <p>If there are multiple alarms, the system will announce the first and last zones that have gone into alarm.</p> <p>NOTE: Fire annunciation always overrides any Burglary Zone alarm annunciation. Verbal Alarm will cease with the siren at Bell Time-out.</p>
		OFF	<p>Verbal Alarm is Disabled. The system will only announce via the bell outputs during an audible alarm condition. This option is defaulted OFF.</p>
4	Waterflow Silence Inhibit	ON	<p>Waterflow Silence Enabled. An Instant or Delayed 24-hr waterflow alarm can not be silenced by any means (including Bell Time-out) until all waterflow zones on the system are restored.</p>
		OFF	<p>Waterflow Silence Disabled. Alarms can be silenced whether a waterflow zone is open on the system or not. This Option is OFF at default.</p>
5	Keypad Buzzer Alarm	ON	<p>Keypad Buzzer Follows Bell Enabled. The keypad buzzers will follow the selected partition's bell activity.</p>
		OFF	<p>Keypad Buzzer Follows Bell Disabled. The keypad buzzer will not follow all bell activity. Only alarms designated to activate the keypad buzzer will do so. This option is OFF at default.</p>
6	Cross Zoning / Police Zone Select	ON	<p>Cross Zoning is Enabled. The panel will use the Cross Zone attribute for Burglary verification. This feature requires two or more trips on a zone(s) designated as 'cross zones' within a specified time before starting an alarm sequence. See Section [101], Option 9, Pg 33.</p> <p>When a zone with the Cross Zone attribute enabled is violated, nothing occurs on the local premises (except Entry Delay or System Event PGM output activation, if applicable) and the Cross Zone Timer commences. If another zone with the Cross Zone attribute enabled is violated before the timer expires, the panel will transmit the first alarm signal, a Cross Zone event, followed by the second zone alarm, and begins the appropriate local alarm sequence. If no other zones are violated before the timer expires, no alarm sequence occurs and an Alarm Not Verified event is logged. If the Double Hit feature is enabled (Section [017], Option 4), the panel will react on two violations of the same zone during the Cross Zone Timer (Section [176]) for starting an alarm sequence.</p> <p>This option is dependent on the programming of the Burglary Verification Options (Section [018], Option 6). It is not enabled if Police Code is enabled.</p> <p>This option will not function on zones that do not log alarm events (e.g., while disarmed, Day Zone, Instant zone, etc.).</p> <p>NOTE: The Cross Zone/Police Code Timer is in seconds for Cross Zoning and in minutes for Police Code. No fire zones types should use the Cross Zone Attribute.</p>
		OFF	<p>Police Code is Enabled. The panel will use the Police Code feature for Burglary Verification. This option is OFF at default.</p> <p>NOTE: Each zone has the ability to individually protect the intended area.</p>
7	Exit Delay Restart	ON	<p>One Time Exit Delay Restart on Delay zone re-entry Enabled. If a Delay zone is violated and restored during the Exit Delay, it is considered an exit. If a delay zone is violated again it is considered a re-entry. With this option enabled the panel will restart the Exit Delay. Further violations and restores of delay zones will not restart the Exit Delay. NOTE: Option is ON by default.</p>
		OFF	<p>One Time Exit Delay Restart on Delay Zone Re-entry Disabled. Delay zone violations and restores will not restart the Exit Delay.</p> <p>NOTE: The Exit Delay can only be restarted once. This includes restarts from Away function keys.</p>
8	AC Trouble Beeps	ON	<p>AC Trouble Beeps Enabled. When an AC Trouble occurs on the panel, all keypads will sound an audible Trouble indication (2 beeps every 10 seconds)</p>
		OFF	<p>AC Trouble Beeps Disabled. AC Troubles will remain silent. This option is OFF at default.</p>

[020] - Keypad Zone Assignment

Assigning Keypad Zones

Each keypad has a zone input to which a device (e.g., a door contact) can be connected (see section 2.11 'Keypad Zones' for wiring information.)

Once the keypad zones are installed, enter the 2-digit zone designated for each keypad (slot), from 01-64.

NOTE: 24-hr Supervisory (LINKS) and LINKS Answer Zones cannot be used on keypad zones.

Fire zones can not be used on keypad zones if DEOL is enabled.

[030] - Fast Loop Response

An eight bit toggle option controls which main board zones have Fast Loop (36 ms) or Normal Loop Response (540 ms). Fast Loop Response is typically used for vibration sensors.

5.4 Advanced Programming PWS Sect 4

[101]-[164] Zone Attributes

The two sets of attributes (1-8 and 9-16) can be toggled by pressing '9' within any zone's attribute section. If the Ready LED is on, the keypad is indicating Zone Attributes 1-8; if the Ready and Armed LED's are on, the keypad is indicating Zone Attributes 9-16. The following options can be enabled or disabled by zone.

NOTE: DO NOT change Fire zones attributes from the default settings.

[101]-[164] ZONE ATTRIBUTES			
Option	Attribute	On/Off	Description
1	Bell	ON	An alarm will cause the bell output to activate.
		OFF	Silent Alarm
2	Bell Type	ON	The bell output will be steady when the zone is in alarm.
		OFF	The bell output will pulse when the zone is in alarm.
3	Chime	ON	Every keypad will chime when the zone is violated and when the zone is secured. Door Chime will work in both the armed and disarmed states.
		OFF	The zone will not chime the keypads.
4	Bypass	ON	The zone can be manually bypassed.
		OFF	The zone cannot be bypassed.
5	Force Arming	ON	The system (partition) can be armed with the zone violated. The zone will be temporarily bypassed, and when the zone is secured it will be added back into the system.
		OFF	The system cannot be armed if this zone is open.
6	Swinger Shutdown	ON	The zone will shut down after a programmed number of alarms, inhibiting further transmissions to the monitoring station. The bell can follow swinger shutdown if programmed.
		OFF	Swinger Shutdown Disabled
7	Transmission Delay	ON	The reporting of zone alarms will be delayed for the programmed time. If a valid access code is entered within this time, no alarm signal will be communicated.
		OFF	When an alarm occurs, the reporting code is transmitted immediately. NOTE: Transmission Delay cannot be used on fire zones.
8	Wireless	ON	Zone is Wireless. The zone will ignore the main board zone (if applicable) and respond to the corresponding zone enrolled on the PC5132.
		OFF	Zone is Hardwired. The zone uses the corresponding hardwired zone.
9	Cross Zone	ON	Zone is a Cross Zone. Zone is enabled for Cross Zoning.
		OFF	Zone is not a Cross Zone. Zone is not enabled for Cross Zoning. The default state for the Cross Zone attribute is OFF for all zone types. NOTE: DO NOT change Fire Zones attributes from the default settings.

[165] - Maximum Dialing Attempts To Each Phone Number

This value represents the number of attempts that will be made to each telephone number when communicating. The default value is 007 attempts. Valid entries are 001-015.

NOTE: The PC5020 will not allow more than 15 dialing attempts to a single phone number. If a value higher than 15 is programmed in Section [165], the panel will still only make 15 attempts.

[166] - Post-Dial Wait For Handshake

This value represents the time the communicator waits for a valid initial handshake from the receiver after dialing the programmed telephone number. The default value is 040 seconds.

[167] - T-Link Interface Communications Wait for Acknowledge

This value represents the time the communicator waits for an ACK from the receiver after sending a SIA Packet. The default is 020 seconds.

[170]-[178] Timers

[170] - PGM Output Timer

This value represents the period of time (in seconds) that a PGM will activate if programmed to follow the PGM Timer.

The default value is 005 seconds. Valid entries are 001-255.

NOTE: This option does not affect outputs programmed as Sensor Reset (Type 03).

NOTE: If a System Event PGM is programmed to follow the Command Output Timer, all attributes must be enabled.

[175] - Auto-arm Postpone Timer

This feature controls the sequence of events after a valid access code is entered during the Auto-arm Pre-alert. If the Auto-arm Postpone Timer is programmed as 000, the Auto-arm will be cancelled. If a value between 001 and 255 is programmed, then the Auto-arm will be postponed for the corresponding number of minutes and the panel will resume normal operation. The panel will also log the appropriate user log for the access code which postponed the arming. When the postpone time expires, the panel Auto-arm Pre-alert will be re-initiated (unless the parti-

tion is armed). The Auto-arm can be postponed multiple times. If the Auto-arm is postponed, arming or disarming the panel will not affect the postpone sequence.

[176] - Cross Zone/Police Code Timer

This option affects the Cross Zone Police Code log and transmission as well as the Cross Zone feature.

When a zone trip occurs, the Cross Zone Timer starts. This timer affects the panel in two different ways depending on the programming of the Burglary Verification Options (Section [018], Option 6):

- If the Police Code feature is being used, the first zone alarm will immediately transmit. If a second zone alarm occurs in the time period (minutes) programmed in this section, the panel will log and transmit the Police Code event. If the second zone alarm occurs after this timer expires, the Police Code will not be logged or transmitted, and the timer will restart.
- If the new Cross Zone attribute is used, the first zone alarm will not log or transmit. If a second zone is violated within the Cross Zone Timer’s duration (seconds), the panel will go into the appropriate alarm sequence and will communicate both zone alarms. No Police Code is sent.

NOTE: If 000 is programmed in this section, either: the Police Code will transmit for any two different zone alarms during an armed-to-armed period or the new Cross Zoning feature will not work. This is not a valid entry for Cross Zoning.

NOTE: Option[9], Section [101]-[164] must be enabled for the Cross Zoning feature to function. Each zone has the ability to individually protect the intended area. Cross Zoning is NOT recommended for line security installations or on exit/entry zones.

[177] - Waterflow Delay Timer

This option affects the Delayed 24-hr waterflow zone type. The value programmed in this section is the time for which the zone has to be violated before going into alarm. Valid entries are from 000 to 090 seconds, with a default of 000.

NOTE: The total delay time (combination of control unit plus waterflow device) for a waterflow zone alarm is not to exceed 120 seconds.

[178] - Alarm Tone Period for Verbal Alarm

This is the period of time that the system will sound the bell outputs before silencing them and verbally annunciating the alarms through the PC5936/Escort5580(TC). Valid entries for this section are 001-255, and the default value is 15 seconds.

[181]-[188] - Auto-arm Schedules

Sections [181] through [188] allow the installer to program seven independent times of the day when the selected partition will arm when Auto-arm is enabled. The 7 entries represent the days of the week as indicated below:

NOTE: Valid entries are 0000-2359 hrs; 9999 to disable.

[18X] Partition X Auto-arm Times

Day	Default	
Sunday	9999	□□□□□□
Monday	9999	□□□□□□
Tuesday	9999	□□□□□□
Wednesday	9999	□□□□□□
Thursday	9999	□□□□□□
Friday	9999	□□□□□□
Saturday	9999	□□□□□□

X = partition to which the section belongs (i.e. Section [182] = partition two schedule). In addition to these schedules, partitions can be enabled or disabled in [*][6] programming. This is controlled by Option 2 in Section [017].

[190] - No Activity Arming Pre-Alert Duration

This is the duration for which the No Activity Arming Pre-alert will sound when the No Activity Timer for the partition expires (see Section [191]-[198]). If programmed as 000, the partition will arm as soon as its No Activity Timer expires. This feature enables the system (or partition) to arm if there is no zone activity for a programmed time period. If the **No Activity Arm** option for a partition is programmed with a number other than 000, the partition will Auto-arm if no activity is detected for the programmed number of minutes.

[191]-[198] - No-Activity Timer (Partition 1-8)

The timer will begin when a delay type zone assigned to the partition is restored. The timer is stopped if any zone assigned to the partition is tripped or restored. The timer will restart when a delay type zone is again restored. When the timer expires, the panel will sound the buzzers of all keypads assigned to the partition for the time programmed in Section [190]. If any key is pressed or zone is violated/restored on that partition, the Auto-arm Pre-alert will be aborted. For zone types 04, 05, 06, and 25, restorals will not affect No Activity Arming. A partition begins its Auto-arm sequence when its No-Activity Timer expires. If 000 is programmed in a section, No-Activity Arming for that partition is disabled. Valid entries are 000 - 255 minutes, with a default of 001.

The system will not arm if it is in OFF normal state.

[199] - Auto-arming Pre-Alert Time

This section allows programming of the standard Auto-arm Pre-alert duration. If Auto-arm is postponed this timer will re-start after the Auto-arm Postpone Timer expires. Valid entries are from 001 - 255 minutes, the default is 005.

NOTE: There is no differentiation between the No Activity Pre-alert and the Standard Auto-arm Pre-alert at a keypad. No Activity Arming and Auto-arm will log and transmit as a Special Closing.

5.5 Partition & Zone Programming

[201] Partition Selection Mask

This section allows the programming of which partitions will be active on the system.

[202]-[265] - Partition Zone Assignments

Partitions and Zone Assignment

A partition is a limited area of the premises which will operate independently of another area of the premises. You can create up to eight partitions on the PC5020 system.

To set up the system for more than one partition, you must turn on each partition in section [201].

You can assign any zone to any of the partitions. **Global Zones** are zones assigned to more than one partition. A global zone will only be armed when all assigned partitions are armed. The zone will be disarmed when any assigned partition is disarmed.

By default, zones 1 through 8 are assigned to partition 1. If additional zones are being used, or if the application requires more than one partition, you must program which zones are assigned to which partitions. You can do this in programming sections [202] - [265].

NOTE: You can assign any Access Code to work on any of the partitions (see section ‘[*] [5] Programming Access Codes’).

You can assign keypads to work on either a single partition, or on all partitions (Global operation). See Section 2 'Keypad Assignment'.

Each partition can be programmed to report using a different account number.

Some of the Programmable Output options are also selectable by partition see Section 5 'Programmable Outputs'.

- Partition 1-8 Enabled/Disabled Section [201]
- Partition 1 Zone Assignments Sections [202] to [209]
- Partition 2 Zone Assignments Sections [210] to [217]
- Partition 3 Zone Assignments Sections [218] to [225]
- Partition 4 Zone Assignments Sections [226] to [233]
- Partition 5 Zone Assignments Sections [234] to [241]
- Partition 6 Zone Assignments Sections [242] to [249]
- Partition 7 Zone Assignments Sections [250] to [257]
- Partition 8 Zone Assignments Sections [258] to [265]

These 8-bit toggle sections determine which partitions each individual zone is assigned to. If a zone is enabled on any partition, it will be supervised via the panel's EOL supervision, and will operate according to the zone type programmed. If a zone is not assigned to any partition, it will not be supervised and all activity on the zone will be ignored by the panel.

5.6 Communicator Programming PWS Sect6

[301]-[304] Communicator - Telephone Numbers

The panel can call 3 different telephone numbers for communication to a central station. The **1st Telephone Number** is the primary number, the **2nd Telephone Number** is the secondary number and the **3rd Telephone Number** will back up the 1st telephone number if enabled.

NOTE: The 3rd Telephone Number will NOT back up the 2nd Telephone Number.

If Alternate Dial is enabled the panel will alternate between the 1st and 3rd telephone numbers when attempting to call the central station. If disabled the panel will only attempt to call the 3rd telephone number after failing to communicate on the 1st telephone number.

NOTE: For Alternate Dial to work properly the 3rd telephone number must be both enabled and programmed.

Telephone numbers can be up to 32 digits which will allow you to add special digits if required. To program the telephone number enter numbers 0 - 9 as required.

To communicate events over a LAN or WAN network using the T-Link module, program the desired phone number with DCAA. This allows the panel to send events to the T-Link module in the SIA format via the PC-Link connection.

Pressing [#] in these sections from an LED keypad will exit and delete the rest of the phone number. Pressing [#] in these sections from an LCD keypad will exit and save the entire phone number up to the first Hex F.

The following is a list of Hex digits which can also be programmed and the functions they perform:

- Hex (A) -not used
- Hex (B) -simulates the [*] key on a tone telephone
- Hex (C) -simulates the [#] key on a tone telephone
- Hex (D) -forces the panel to search for dial tone
- Hex (E) -forces the panel to pause for 2 seconds
- Hex (F) -end of telephone number marker

3rd Telephone Number Enable	Section [380], Option [5]
Alternate Dial	Section [380], Option [6]
Downloading Options	(Section 7: PWS)

[301] - First Telephone Number

[302] - Second Telephone Number

[303] - Third Telephone Number

NOTE: There is a static delay of 2 seconds before any additional dial tone search in a phone number.

NOTE: The panel will not attempt to communicate, if no phone number is programmed. This applies to phone numbers 1, 2 and 3.

[304] - Call Waiting Cancel Dialing String

This is a 6-digit Hex entry that is used to disable Call Waiting on a Call Waiting-equipped phone line. This is typically *70 in most areas. Dialing this string before a phone number will disable Call Waiting for the duration of the call. If this section is programmed (not FF), and Section 382, Option 4 is ON, the panel will dial this string in place of the first digit of the phone number (Sections [301]-[303]). This only applies to the first attempt that is made to each phone number.

NOTE: If not all 6 digits are required they should be filled with Hex F.

All 6 digits of this section need to be programmed in order for any changes to be accepted.

Communicator - Account Codes

The System Account Code will be used by the panel when communicating System events (e.g. Low Battery, Test Transmission). This account code can be up to six digits in length for the SIA Communications format. Only the SIA reporting format supports six-digit account codes. All other formats will use the first four digits of the account code.

NOTE: If the communicator is programmed for the SIA reporting format, the system will use this account code for all partitions.

There are eight **Partition Identifier Codes** (or account codes) programmable, one for each partition. The account code is used by central station to determine which panel is calling.

If you have programmed the system for more than one partition, you must program an account code for each active partition. The panel will report to the central station by partition. For example, if an alarm occurs on a zone assigned to partition 1 the panel will report using partition 1 account code.

[310] - System Account Code

This is the account code used by the panel when communicating System events (e.g., Low Battery, Test Transmission). This account code can be up to six digits in length for the SIA Communications format.

Only SIA supports 6-digit account codes. If the last two digits of the account code are FF, the panel will only use the first four digits. All other formats will use the first four digits of the account code.

The call directions that use this account code are System Maintenance (Troubles, Zone Faults, etc.) and System Test Transmissions.

NOTE: SIA will use this account code for all partitions and system events. System events will be identified by Nri0, with partitions 1-8 using Nri1-8.

[311]-[317] - Partition 1-8 Account Codes

These account codes are used by the panel when communicating events for partitions 1-8 when using formats other than SIA.

NOTE: All partition account codes are 4 digits in length. Valid entries are 0000-FFFE.

[320] - [349] Reporting Codes

Communicator - Reporting Codes

Unless you are using Automatic Contact ID or Automatic SIA formats, reporting codes must be programmed in order for the panel to report events to the central station.

Reporting codes are two digits and can use hexadecimal digits A through F. To disable a reporting code, program it as FF (default setting) or 00. For a complete description of reporting codes which can be programmed and lists of Automatic Contact ID and SIA format codes, see section Appendix A: 'Reporting Codes'.

[320]-[323] - Alarm Reporting Codes, Zones 1-64

The panel will transmit the Zone Alarm reporting code for a zone when the zone goes into alarm. 24-hr type zones will go into alarm whether the panel is armed or disarmed and report to the central station. All other zone types will only go into alarm if the panel is armed.

Reporting codes can be one or two digits and can use Hex digits (A through F). The following is a description of the different reporting codes that can be programmed and when the events will be reported to the central station.

[324]-[327] - Alarm Restoral Reporting Codes, Zones 1-64

If the **Restoral on Bell Time-out** option is selected the panel will send the **Zone Restoral** Reporting Code for the zone when the alarm output times out AND the zone is secure. If the zone is not secured when the alarm output times out the panel will send the restoral immediately after the zone is secured.

If the **Restoral on Bell Time-out** option is not selected the panel will immediately send the Zone Restoral reporting code when the zone is secured or when the panel is disarmed, regardless if the alarm output is active or not.

NOTE: 24-hr type zones will report the restoral immediately after the zone is secured.

[328] - Miscellaneous Alarm Reporting Codes

Duress Alarm: this reporting code will be transmitted to the monitoring station whenever a Duress code is used to perform any function on the system.

Opening After Alarm: this reporting code will be transmitted to the monitoring station on opening if an alarm has occurred during the previous armed period.

Recent Closing: a Recent Closing transmission will be sent if an alarm occurs within 2 minutes of an exit time expiration. The Recent Closing report will be sent for the first alarm only.

Zone Expander Supervisory Alarm: this reporting code is sent when the system loses communications with any zone expander module (PC5108, PC5132, or keypad with on-board zone).

Zone Expander Supervisory Restoral: this reporting code is sent when the system regains communications with all zone expander modules (PC5108, PC5132, or keypad with on-board zone) that have been enrolled on the system.

Cross Zone / Police Code Alarm: When using Cross Zoning (Section 018, Option 6 ON), this reporting code will be sent when two Crossed Zones go into alarm during the cross zone period.

When using Police Code (Section 018, Option 6 OFF), this reporting code will be sent when any two zones go into alarm.

If the **Double Hit** option has been enabled, this reporting code will be sent when two zone alarms occur on the same zone and the Burglary Verified timer has not expired.

NOTE: Only one reporting code will be sent during each armed to armed period when using Police Code.

Burglary Not Verified: this reporting code will be sent after the Burglary Verified Timer expires after a zone alarm occurs.

Alarm Cancelled: this reporting code will be sent if a valid access code is entered during the Alarm Cancel window. If a valid access code is entered during this window, then the Alarm Cancelled event is logged and sent. When the central station has acknowledged this reporting code/event, a keypad ring-back will occur.

[329] - Priority Alarm and Restoral Reporting Codes

[F], [A], [P] Alarm: this reporting code will be sent if the [F] [A] or [P] key is used to generate manual alarms.

Auxiliary Input Alarm: this reporting code will be sent when PGM2 is being used for 2-wire smoke detectors and the 2-wire smoke detector goes into alarm.

[F], [A], [P] Restoral: this reporting code will be sent after the [F] [A] [P] alarm reporting code is sent.

Auxiliary Input Restoral: the panel will transmit this reporting code when the 2-wire smoke detector has restored after an alarm.

[330]-[333] - Tamper Reporting Codes, Zones 1-64

If the panel is programmed for Double EOL zones (see Section 2.10 "Zone Wiring") the panel will report a **Zone Tamper Alarm** reporting code if an open condition is present on a zone. A different reporting code can be programmed for each zone for identification.

[334]-[337] - Tamper Reporting Codes, Zones 1-64

The **Zone Tamper Restoral** reporting code will be transmitted immediately when the Tamper condition is restored.

[338] - Miscellaneous Tamper Reporting Codes

General System Tamper: a **General System Tamper** Reporting code will be transmitted when the tamper zone on any module is violated.

General System Tamper Restoral: the **General System Tamper Restoral** reporting code will be transmitted when the tamper zone on the module is restored.

Keypad Lockout: the panel will transmit the **Keypad Lockout** reporting code if the lockout is activated.

[339]-[340] - Closing (Arming) Reporting Codes, Zones 1-32

The panel will transmit a **Closing** reporting code to indicate a partition(s) is armed. A different reporting code can be transmitted for each User Code, Partition Master Code and System Master Code to identify who armed the partition(s).

[341] - Miscellaneous Closing (Arming) Reporting Codes

Closing by Duress Code 33/34: a **Closing by Duress** code Reporting code will be transmitted in addition to the Duress reporting code if a partition(s) is armed using a Duress Code.

Closing by Master or Supervisory Code: the panel will transmit a **Closing** reporting code to indicate a partition(s) is armed. A different reporting code can be transmitted for each User Code, Supervisory Code and System Master Code to identify who armed the partition(s).

Partial Closing: a **Partial Closing** reporting code will be transmitted if a partition is armed with zones manually bypassed. The code will also be transmitted if a partition Auto-arms with zone(s) in violation.

Special Closing: a **Special Closing** reporting code will be transmitted if the partition(s) is armed using any of the following methods:

- Quick Arm
- Auto-arm
- Arming via the DLS Software
- Arming via Keyswitch
- Away Function Key Arming
- Arming with the Maintenance Code.
- Stay Function Key arming

Late to Close: A **Late to Close** reporting code will be transmitted if a partition isn't armed before the auto-arm start time when the late to close option, (Section 017, option 5) is enabled.

Exit Fault: If an **Exit Fault Pre-Alert** occurs and Entry Delay expires before the system is disarmed, Exit Fault will be logged and this reporting code will be sent.

[342]-[343] - Opening (Disarming) Reporting Codes Access Codes 1-32

The panel will transmit an **Opening** reporting code to indicate partition(s) is disarmed. A different reporting code can be transmitted for each user code, partition master code and system master code to identify who armed the partition(s).

[344] - Miscellaneous Opening (Disarming) Reporting Codes

Opening by Duress Code 33/34: This reporting code will be transmitted in addition to the duress reporting code if a partition(s) is disarmed using a Duress Code

Opening by Master or Supervisory Code: The panel will transmit this reporting code to indicate a partition(s) is armed. A different reporting code can be transmitted for each User Code, Supervisory Code and System Master Code to identify who armed the partition(s).

Auto Arm Cancellation: This reporting code is transmitted when the Auto Arming sequence is canceled or Postponed

Special Opening: A **Special Opening** reporting code will be transmitted if the partition(s) is disarmed using any of the following methods:

- Disarming using the Maintenance Code
- Disarming via the DLS Software
- Disarming via keyswitch

[345] - Maintenance Alarm Reporting Codes

Battery Trouble Alarm: the panel will transmit a **Battery Trouble Alarm** reporting code when the backup battery drops below 11.5 VDC.

AC Failure Trouble Alarm: the panel will transmit an **AC Failure Trouble Alarm** reporting code when the AC to the panel is lost and the AC Failure Communication Delay timer expires.

Bell Circuit Trouble Alarm: a **Bell Circuit Trouble Alarm** reporting code will be transmitted immediately if an open condition is measured on the Bell Output of the main panel.

Fire Trouble Alarm: a **Fire Trouble Alarm** reporting code will be transmitted immediately when an open condition is measured on any fire zone.

Auxiliary Power Supply Trouble Alarm: the **Auxiliary Power Supply Trouble Alarm** reporting code will be transmitted if the AUX output is shorted.

TLM Trouble: a **TLM Trouble** reporting code can only be transmitted if a LINKS1000/2X50 Communicator is being used (see Section 5.26 LINKS1000 Cellular Communicator). The panel will only transmit the signal after the time programmed for the TLM Trouble Delay.

General System Trouble: a **General System Trouble** reporting code will be transmitted if the panel detects any of the following:

- AC Power Failure
- Low Battery
- AUX Output Trouble
- Output #1 on the PC5200/PC5204 Power Supply/Output Module.

General System Supervisory Trouble: a **General System Supervisory Trouble** reporting code will be transmitted if any module goes missing from the Keybus. If the module is a zone expander the panel will also transmit the **Zone Expander Supervisory Alarm Trouble** reporting code.

[346] - Maintenance Restoral Reporting Codes

Battery Trouble Restoral: the **Battery Trouble Restoral** reporting code will not be transmitted until the battery has been charged over 12.5 VDC.

AC Failure Trouble Restoral: the **AC Failure Trouble Restoral** reporting code will be transmitted once AC power has been restored for the amount of time programmed for AC Failure Communication delays.

Bell Circuit Trouble Restoral: the **Bell Circuit Trouble Restoral** reporting code will be transmitted as soon as the open condition on the bell output is corrected.

Fire Trouble Restoral: the **Fire Trouble Restoral** reporting code will be transmitted when the correct resistance value is measured on any Fire type zone.

Auxiliary Power Supply Trouble Restoral: the panel constantly checks the AUX output, when the excessive current draw is removed the panel will reset the output and transmit an **Auxiliary Power Supply Trouble Restoral** reporting code.

TLM Restoral: the TLM Restoral reporting code will be transmitted immediately after the Trouble is restored.

General System Trouble Restoral: a General System Trouble Restoral reporting code will be transmitted when the panel detects none of the following:

- AC Power Failure
- Low Battery
- AUX Output Trouble
- Output #1 on the PC5200 / PC5204 power Supply/Output Module after a Trouble was reported.

General System Supervisory Restoral: the General System Trouble Restoral reporting code will be transmitted when the control panel detects all modules enrolled on the keybus

[347] - Miscellaneous Maintenance Reporting Codes

Telephone Number 1 (2) FTC Restore: if the panel fails to transmit information to the central station it will display a failure to communicate Trouble condition. The panel will transmit a **Phone Number 1 Failure to Communicate** reporting code or a **Phone Number 2 Failure to Communicate** reporting code the next time it calls the central station. The panel will transmit the old events, followed by the failure to communicate, followed by the new events.

Event Buffer 75% Full: If the event buffer is uploaded on a regular basis an **Event Buffer 75% Full** reporting code can be transmitted to warn that the Buffer is almost full.

DLS Lead In: The **DLS Lead In** reporting code will only be transmitted if the DLS Call Back feature is being used (see Section 5.8 "Downloading"). Before the panel calls the computer back it will call the central station and transmit the reporting code to indicate a download session is about to begin.

DLS Lead Out: After a downloading session is attempted and/or completed, the panel will transmit a **DLS Lead Out** reporting code.

Zone Fault Alarm: The **Zone Fault Alarm** reporting code will be transmitted when there is a short detected on any DEOL zone and/or a loss of Supervisory on a wireless zone.

Zone Fault Restoral: The **Zone Fault Restoral** reporting code will be transmitted when the fault condition on the zone is corrected.

Delinquency Code: The **Delinquency** reporting code is sent whenever the panel is not armed within the number of days programmed for the Delinquency Transmission Delay.

General Zone Low Battery Alarm: the panel will transmit a **General Zone Low Battery Alarm** reporting code when a wireless detector indicates a low battery condition and the delay programmed in Zone Low Battery Transmission Delay expires.

General Zone Low Battery Restoral: the General Zone Low Battery Restoral reporting code will be transmitted when the low battery condition on all wireless zones is corrected. The specific zone that caused the trouble will be stored to the event buffer.

Installer Lead In: a reporting code will be sent to the central monitoring station when Installer Programming is entered through the keypad.

Installer Lead Out: a reporting code will be sent to the central monitoring station when Installers programming is exited.

[348] - Test Transmission Reporting Codes

Walk Test End: the **Walk Test End** reporting code will be transmitted when a Walk Test is terminated.

Walk Test Begin: the **Walk Test Begin** reporting code will be transmitted when a Walk Test is initiated.

Periodic Test Transmission with Trouble - the panel can be programmed to transmit a **Periodic Test Transmission** with Trouble reporting code in place of the standard Periodic Test Transmission if any of the following conditions exist.

- Fire Zone Trouble (Zones 1-64)
- Battery Trouble (PC5020, PC520X)
- Fire Zone Alarm (Zones 1-64, Two-Wire Smoke)
- Aux Trouble (PC5020)
- Fire Trouble (2-wire Smoke)
- Bell Trouble (PC5020)
- Fire Tamper/Low Sensitivity (Wireless/AML Zones 1-32)
- Module Supervisory
- Fire Zones Bypassed (Zones 1-64)
- Ground Fault (PC5700)
- Fire Supervisory (Wireless/AML Zones 1-32)
- TLM Trouble (PC5020, PC5700 Line 1-2)
- AC Trouble (PC5020, PC520X)
- FTC Trouble

Periodic Test Transmission: the Periodic Test Transmission reporting code will be transmitted at the specified time, (programmed in Section 378) every X number of days (see Section 377).

System Test: the System Test reporting code will be transmitted when a system test is performed on the panel.

Links 1000 Test Transmission Code: the Links1000 Test Transmission reporting code will be transmitted via the LINKS1000 cellular transmitter at the programmed interval (see 'Test Transmission Cycles' section [378]) and time of day (see Section [377]) of the LINKS Periodic Test Transmission.

NOTE: To disable this transmission of this reporting code, 00 must be entered.

[349] - PC5700 Maintenance Reporting Codes

PC5700 Ground Fault Trouble: the panel will transmit this reporting code when a Ground Fault Trouble occurs on the PC5700.

PC5700 Ground Fault Restoral: the panel will transmit this reporting code when the Ground Fault Trouble condition has restored on the PC5700.

PC5700 TLM 1(2) Trouble: the panel will transmit this reporting code when a TLM Trouble occurs on the PC5700 line 1 and/or on line 2.

PC5700 TLM 1(2) Restoral: the panel will transmit this reporting code when a TLM Restoral occurs on the PC5700 line 1 and/or line 2.

[350] - Communicator Format Options

Communicator - Reporting Formats

Each central station telephone number of the panel can be programmed to report using any one of the 5 formats available. The following formats are supported: Pulse (10 and 20 bps), Contact ID, SIA, Residential Dial and a Pager format. The following is a description of each.

SIA (Level 2)

SIA is a specialized format that will communicate information quickly using frequency shift keying (FSK) rather than pulses. The SIA format will automatically generate the type of signal being transmitted, such as Burglary, Fire, Panic etc. The two digit reporting code is used to identify the zone or access code number.

NOTE: SIA format must be used if Downlook is required.

NOTE: SIA format must be used for phone numbers programmed to communicate via the T-Link.

If the SIA format is selected the panel can be programmed to automatically generate all zone and access code numbers eliminating the need to program these items.

If the **SIA Sends Automatic Reporting Codes** option is enabled the panel will operate as follows:

1. If the reporting code for an event is programmed as [00] the panel will not attempt to call the central station.
2. If the reporting code for an event is programmed as anything from [01] to [FF] the panel will AUTOMATICALLY generate the zone or access code number.
3. Bypassed zones will always be identified when partial closing of the system occurs.

The Communicator Call Direction Options can be used to disable reporting of events such as Openings/Closings. Also, if all the Opening/Closing reporting codes were programmed as [00] the panel would not report.

If the **SIA Sends Automatic Reporting Codes** option is disabled the panel will operate as follows:

1. If the reporting code for an event is programmed as [00] or [FF] the panel will not attempt to call the central station.
2. If the reporting code for an event is programmed as anything from [01] to [FE] the panel will send the programmed reporting code.
3. Bypassed zones will not be identified when partial closing the system.

NOTE: If using Downlook, do not program the second telephone number for the SIA reporting code format (Section [360]) if the Automatic Reporting Code option is enabled (Section [381]).

NOTE: The zone number for Zone Low Battery and Zone Fault events will not be identified when Programmed SIA is used.

.....

SIA Sends Automatic Reporting Codes	Section [381], Option [3]
Communicator Call Direction Options	Section [351] to [376]
SIA Identifiers	Appendix A

.....

Residential Dial

If Residential Dial is programmed and an event programmed to communicate occurs, the panel will seize the

line and dial the appropriate telephone number(s). Once the dialing is complete, the panel will emit an ID tone and wait for a handshake (press a 1, 2, 4, 5, 7, 8, 0, * or # key from any telephone). It will wait for this handshake for the duration of **Post Dial Wait for Handshake** timer. Once the panel receives the handshake, it will emit an alarm tone over the telephone line for 20 seconds. If several alarms occur at the same time, only one call will be made to each telephone number the panel is programmed to call.

NOTE: *The Residential Dial format will not work over the LINKS1000.*

.....
 Communicator Call Direction Options Section [361] to [368]

Pager Format

The **Communicator Format** option for either telephone number can be programmed for Pager format. If an event occurs and the **Communicator Call Direction** options direct the call to a telephone number with the Pager format selected the panel will attempt to page.

When calling a pager extra digits will be required to make it work properly. The following is a list of Hex digits and the function they perform:

- Hex [A] - not used
- Hex [B] - simulates the [] key on a tone telephone
- Hex [E] - two second pause
- Hex [C] - simulates the [#] key on a tone telephone
- Hex [F] - end of telephone number marker
- Hex [D] - forces the panel to search for dial tone

The panel will attempt to call the pager one time. After dialing the digits in the telephone number the panel will send the account number and reporting code followed by the [#] key (Hex [C]).

There is no ringback when using Pager format. The panel has no way of confirming if the pager was called successfully; a Failure to Communicate Trouble will only be generated once the maximum number of attempts has been reached.

NOTE: *The Pager format cannot be used with the LINKS1000 cellular communicator.*

NOTE: *Do not use the digit C in a reporting code when using Pager format. In most cases, the digit C will be interpreted as a [#], which will terminate the page before it has finished.*

NOTE: *If the panel detects a busy signal, it will attempt to page again. It will make the maximum number of attempts programmed in section [165]. Force dialing should be disabled when using Pager format.*

NOTE: *When using Pager format, you must program two hex digit Es at the end of the telephone number.*

Pulse Formats

Depending on the pulse format selected the panel will communicate using the following:

- 3/1, 3/2, 4/1 or 4/2
- 1400 or 2300 Hz handshake
- 10 or 20 bits per second
- non-extended

The digit '0' will send no pulses and is used as a filler. When programming account numbers enter four digits. When programming a 3-digit account number the fourth digit must be programmed as a plain '0' which will act as a filler digit.

If an account number has a '0' in it, substitute a Hex digit 'A' for the '0'. Examples:

- 3-digit account number [123]- program [1230]
- 3-digit account number [502] - program [5A20]

- 4-digit account number [4079] - program [4A79]

When programming reporting codes two digits must be entered. If one digit reporting codes are to be used the second digit must be programmed as a '0'. If a '0' is to be transmitted substitute a Hex digit 'A' for the '0'. Examples:

- 1-digit reporting code [3] - program [30]
- 2-digit reporting code [30] - program [3A]

To prevent the panel from reporting an event program the reporting code for the event as [00] or [FF].

NOTE: *This communication format cannot be selected if Downlook is required.*

Contact ID

Contact ID is a specialized format that will communicate information quickly using tones rather than pulses. In addition to sending information more quickly the format also allows more information to be sent. For example, rather than reporting an alarm zone 1 the Contact ID format can also report the type of alarm, such as Entry/Exit alarm zone 1.

If **Contact ID Sends Automatic Reporting Codes** is selected, the panel will automatically generate a reporting code for each event. These identifiers are listed in Appendix A. If the Automatic Contact ID option is not selected, reporting codes must be programmed. The 2-digit entry determines the type of alarm. The panel will automatically generate all other information, including the zone number.

NOTE: *If the Automatic Contact ID option is selected, the panel will automatically generate all zone and access code numbers, eliminating the need to program these items.*

NOTE: *The zone number for Zone Low Battery and Zone Fault events will not be identified when Programmed Contact ID is used.*

If the **Contact ID Uses Automatic Reporting Codes** option is enabled, the panel will operate as follows:

- If an event's reporting code is programmed as [00], the panel will not attempt to call the central station.
- If the reporting code for an event is programmed as anything from [01] to [FF], the panel will automatically generate the zone or access code number. See Appendix A for a list of the codes which will be transmitted.

If the **Contact ID Uses Programmed Reporting Codes** option is enabled, the panel will operate as follows:

- If an event's reporting code is programmed as [00] or [FF], the panel will not attempt to call central station.
- If the reporting code for an event is programmed as anything from [01] to [FE], the panel will send the programmed reporting code.
- Account numbers must be four digits.
- If the digit 0 is in the account number substitute the Hex digit A for the 0.
- All reporting codes must be two digits.
- If the digit 0 is in the reporting code substitute the Hex digit A for the 0.
- To prevent the panel from reporting an event program the reporting code for the event as [00] or [FF].

NOTE: *This communication format cannot be selected if Downlook is required.*

.....
 Contact ID Sends Automatic
 Reporting Codes Section [381], Option [7]

This section requires 2 two-digit entries (1 per phone number). The 3rd telephone number uses the format programmed for the 1st telephone number.

Entry	Communication Format
01	20 bps, 1400 HZ handshake
02	20 bps, 2300 HZ handshake
03	CONTACT I.D.
04	SIA FSK
05	Pager
06	Residential Dial
07	10 bps, 1400 Hz handshake
08	10 bps, 2300 Hz handshake

Reporting Codes

- SIA - 0 is valid in account or reporting code (not 00 in a reporting code though)
- ADEMCO Contact ID - 0 is not valid in account or reporting code (A must be used, 10 in checksum)
- BPS Formats - 0 is not valid in account or reporting code (A must be used)
- SIA - This format uses 300 Baud FSK as the communication medium. The account code can be 4 or 6 hexadecimal digits in length, all reporting codes must be 2-digits in length. The SIA format will transmit a 4- (or 6-digit account code, a 2-digit identifier code and a 2 digit reporting code. The 2-digit identifier is pre-programmed by the panel.

Telephone Line Monitoring (TLM)

When the **TLM Enable** option is selected, the panel will supervise the telephone line and will indicate a Trouble condition if the telephone line is disconnected.

If the **TLM Enable** option is ON, the panel will check the telephone line every 10 seconds. If the telephone line voltage is below 3V for the number of checks programmed in the **TLM Trouble Delay** section, the panel will report a TLM Trouble. The default number of checks is 3. Enter a number from (000) to (255) in the TLM Trouble Delay section to change the number of checks before the TLM Trouble is reported. Programming a delay means that a momentary interruption of the telephone line will not cause a Trouble condition.

If the **TLM Trouble Beeps When Armed** option is enabled, the panel will indicate a TLM Trouble at the keypad while the system is armed. To activate the bell output in the case of a TLM Trouble while the system is armed, the **TLM Audible (Bell) When Armed** option must be selected.

When the Trouble condition is restored, the panel can send a **TLM Restoral** reporting code. Any events which occur while the telephone line is down will also be communicated.

If the LINKS1000 Cellular Communicator, or LINKS2X50 is being used, the panel can be programmed to report a **TLM Trouble** reporting code.

[351]-[376] - Communicator Call Directions

For events from each Call Direction group the control panel can call 2 different phone numbers and use the LINKS as backup or as a redundant communicator for one or both numbers. The third phone number can only be used as a backup or alternate to the first.

Each report falls under one of the following 5 Groups:

1. Partition X Alarms & Restorals
2. Partition X Openings & Closings
3. Partition X Tamperers & Restores
4. System Maintenance Alarms & Restorals
5. System Test Transmissions

Each group can be assigned to the following Call Directions

1. **Option 1** - 1st Telephone Number (and 3rd Telephone Number if enabled for alternate or backup)
2. **Option 2** - 2nd Telephone Number
3. **Option 3** - 1st Telephone Number via LINKS (and 3rd Telephone Number if enabled for alternate or backup)
4. **Option 4** - 2nd Telephone Number via LINKS
5. **Option 5** - Alternate Communicator. This allows the panel to have control of what types of events the LINKS2X50 products will communicate. This Call Direction is enabled at default.

[377] - COMMUNICATION VARIABLES

Swinger Shutdown (Alarms & Restores)

This value defines the number of attempts (alarm and restoral pairs) per zone that the communicator will make before it shuts down for that zone ('swinger shutdown'). Program 001 or 002 in this entry. When programmed as 000, the communicator will shut down after 2 Alarm/Restoral pairs.

Different limits can be programmed for **Zone Alarms**, **Zone Tamperers** and **Maintenance** signals. After the panel has communicated the programmed number of transmissions for an event it will no longer report that event until the swinger shutdown is reset. For example, the swinger shutdown limit for Zone Alarms is set to [001]. The panel will not send more than 1 alarm signal for each zone with a swinger attribute until the swinger shutdown is reset.

The Bell output will not be activated for alarms on zones that have exceeded the limit of alarms set in the Swinger Shutdown counter. Swinger shutdown on global zones will log once to the System Area.

NOTE: Swinger Shutdown will reset on all partitions when any partition on the system is armed, or every day at midnight. Once reset, the panel will again communicate normally

NOTE: The Bell and event buffer can follow Swinger Shutdown if enabled.

Swinger Shutdown (Tamperers & Restorals)

This value defines the number of times the same system Tamper type event will occur before stopping transmissions. Valid entries are 000 to 014.

Swinger Shutdown (Maintenance Troubles & Restorals)

This value defines the number of times the same system Maintenance (Trouble) type event will occur before stopping transmissions. Fire Troubles will follow the Maintenance Swinger Shutdown Variable. Swinger Shutdown is enabled on Zone Types [01]-[06] and [25] on all panels by default, and on all definitions. Valid entries are 000 to 014.

Communication Delay (Seconds)

This value defines the delay before transmission. The delay is for zones which have the Transmission Delay attribute enabled. Program a time from 015 to 045 seconds. This communications transmission delay will be by partition. Each partition will share the same active timer, so if the delay is already active due to an alarm on a different partition, then any new activity on yet another partition will not restart the communications delay timer.

NOTE: If global zones are used with communications delay, then to stop all alarms from being sent when the communications delay expires, access codes must be entered on all partitions that went in alarm from that global zone.

NOTE: If transmission delay starts on one partition, other partitions cannot cancel it. If transmission delay is active on more than one partition, and a code is entered on one of them, that partition's transmission delay will be cancelled.

NOTE: For UL installations the entry delay plus communication delay cannot exceed 60 seconds.

Refer to Zone Attributes Section [101]-[164], Option [7]

***NOTE: Do not use this section for central & remote fire applications.**

[377] - COMMUNICATION VARIABLES			
AC Failure Communication Delay (Minutes/Hours) This value determines the delay before an AC Failure or AC Restoral is reported. The AC failure or restoral is still displayed immediately. Valid entries are from 000 to 255 minutes/hours. NOTE: Selection of minutes or hours for the delay is set in section [382], Option 6. NOTE: If AC Failure Communications Delay is programmed as 000, the AC Failure Trouble reporting code will be sent immediately*.			
TLM Trouble Delay The number of valid checks (10 second interval) required before a Telephone Line Trouble is generated is programmed here. Valid entries are 000-255 for Trouble annunciation and transmission (LINKS) delays of 10 to 2550 Seconds (42.5 Minutes).			
Test Transmission Cycle (Land Line) This value determines the period between Test Transmissions for the Land Line. Valid entries are [000]-[255]. Whether this interval is in minutes or days is determined on Section [702], Option 3. NOTE: Enter [001] for PCS020CF Commercial Fire panel. For Commercial Fire applications enter 001.			
Test Transmission Cycle (LINKS1000) This value determines the period between Test Transmissions for the LINKS1000. Valid entries are [000]-[255]. The period is in days or hours. This applies to Land-line and LINKS Test Transmissions, and for minutes and hours for the Land-line (LINKS only uses Hours). NOTE: When a new value is programmed (locally or remotely), the panel will transmit a Test transmission when the next Test Transmission Time is reached. The panel will then load in the new value, and continue the cycle based on this new value. This informs the Installer/Central to expect the next Test Transmission when the cycle has been changed.			
Wireless Zone Low Battery Transmission Delay (Days) When a zone reports a low battery condition, the Trouble condition will be indicated immediately on the keypad, but the transmission to the monitoring station will be delayed by the number of days programmed in this section. If the user does not correct the low battery condition before the delay expires, the low battery condition will be transmitted. The Low Battery Restoral transmission is not delayed. NOTE: The panel will not send additional low battery events until the first low battery Trouble is restored.			
Delinquency Transmission Delay The value in this section determines the period of time that the Delinquency Event will be postponed until it is logged to the event buffer and transmitted. Whether this value is in hours or days is determined if Delinquency is for Activity (hours) or Closing (days) as specified in Section [380] Option 8. The timer starts under the following conditions: <ul style="list-style-type: none"> • When the system is armed in the Stay mode • When the system is disarmed • When a zone is violated and restored while the system is disarmed/Stay armed (Interior, Interior Delay, Interior Stay/Away, or Delay Stay/Away zones only). The activity delinquency timer will be ignored when the system is armed in the Away mode. Zones that are bypassed in the [*][1] Bypass menu will not reset the timer. If the system is programmed to monitor Closing Delinquency , the timer will be programmed in days. The timer will restart every time the system is disarmed. Activity/Closing Delinquency section [380], option [8].			
Communications Cancel Window After TX Delay expires and a zone alarm has been transmitted, the Cancel window will begin. If an access code is entered during this window, a Communications Cancel reporting code will be communicated. If the window expires without an access code entered or a code is entered after the window, no Opening After Alarm log or communication will occur. The system keypads will provide an audible confirmation that the opening after alarm log was successfully communicated (5 quick beeps).			

[378] - Test Transmission Time of Day

Program the time of the test transmission in this section. Enter a 4-digit time using the 24-hr clock format (HH:MM). Valid entries are from 00 to 23 for the hours (HH) and 00 to 59 for the minutes (MM).

To disable the test transmission, enter [9999] in this section.

NOTE: Do NOT enter [9999] for Central & Remote Fire applications.

[380] - FIRST COMMUNICATOR OPTION CODES			
Option	Communicator Code	On/Off	Description
1	Communications	ON	Communicator Enabled. The system's communicator will be enabled and all events with reporting codes will be reported to the monitoring station. Refer to the Telephone Number, reporting code and Call Direction Programming Sections.
		OFF	Communicator Disabled. The system's communicator will be shut off and events will not be transmitted to the monitoring station. Downloading may still be performed if enabled.
2	Restore Transmission	ON	Restore Transmissions on Bell Time-out. Zone restoral reporting codes will not be transmitted until the zone has been restored and the Bell time-out has expired. If the zone is not restored when the bell time-out expires, the restoral will be transmitted when the zone physically restores or when the system is disarmed. NOTE: 24-hr zones will not restore until the zone is physically restored.
		OFF	Restore Transmissions Follow Zones. Zone restoral reporting codes will be transmitted when the zone is physically restored. If the zones are still active when the system is disarmed, the restore codes will be transmitted when the system is disarmed. NOTE: 24-hr zones will not restore until the zone is physically restored.
3	Dialing Method	ON	Pulse Dialing enabled. The control panel will dial telephone numbers using pulse (rotary) dialing.
		OFF	DTMF Dialing enabled. The control panel will dial telephone numbers using DTMF (dual tone multi-frequency) dialing.
4	Switch to Pulse Dialing	ON	Switch to Pulse Dialing after 4 DTMF attempts. If DTMF dialing is enabled, the control panel will dial telephone numbers using DTMF dialing for the first 4 attempts. If unsuccessful, the control panel will switch to pulse (rotary) dialing for the remaining attempts.
		OFF	DTMF Dial for all Attempts. If DTMF dialing is enabled, the control panel will dial telephone numbers using DTMF dialing for all dialing attempts.

[380] - FIRST COMMUNICATOR OPTION CODES

Option	Communicator Code	On/Off	Description
5	3rd Phone Number Enable	ON	3rd Phone Number Enabled. The 3rd Phone number will be used for Alternate Dialing with the 1st phone number or as a backup of the 1st phone number (see light 6).
		OFF	3rd Phone Number Disabled. The 3rd Phone number will not be used.
6	3rd Phone Number	ON	Alternate Dialing Enabled (1st & 3rd). After each dialing attempt, the communicator switches between the 1st phone number and 3rd phone number.
		OFF	Call 1st Number, Backup to 3rd Number. If the programmed number of attempts to communicate to the First Telephone Number fail, the same number of attempts will be made to communicate to the Third Telephone Number. If all attempts to communicate to the Third Telephone Number fail, a Failure to Communicate Trouble will be generated.
7	LINKS Dialing	ON	Call LINKS as well as Land Line(s). The control panel will dial the programmed number of attempts through the LINKS, followed by the number of programmed attempts over the land-line regardless of whether the communication over the LINKS was successful.
		OFF	LINKS is backup of Land Line(s). The control panel will dial through the LINKS if the panel is having difficulty communicating over the phone line. For each failed attempt to the land line, one attempt will be made to the LINKS1000.
8	Delinquency	ON	Delinquency Follows Zone Activity (Activity Delinquency). This feature assists in the monitoring of the elderly and the handicapped. If there is no zone activity on a partition, the Delinquency Transmission Delay timer in Section [370] will begin counting in hours. When the counter reaches the programmed time, the panel will communicate the Delinquency Code to the central station, if programmed. If there is zone activity present on the system at any time, the counter will be reset. If this option is used, the Closing Delinquency option is not available. NOTE: This code will not be transmitted for partitions that are Away armed. Activity on bypassed zones does not affect this timer. The timer is reset on arming.
		OFF	Delinquency Follows Arming (Closing Delinquency). This reporting code is sent whenever the programmed number of days for Delinquency has expired without the partition being armed. The timer for this feature is programmed in Section [370]. The value programmed in this section determines the number of days of no-arming the partition counts before sending the Delinquency reporting code to the central station. Once this code is sent, the timer will not be started again until the partition has been armed. Each day programmed in the counter represents one day PLUS the time it takes for the partition to reach midnight. This feature may be disabled by programming 000 in Section [370].

[381] - SECOND COMMUNICATOR OPTION CODES

Option	Communicator Code	On/Off	Description
1	Opening After Alarm Keypad Ringback	ON	Opening After Alarm Keypad Ringback Enabled. When the Opening After Alarm reporting code is successfully transmitted to a programmed telephone number, the keypad will sound a series of 8 beeps to confirm to the end user that the Opening After Alarm code was sent and received. This ringback will occur for each Opening After Alarm code successfully reported.
		OFF	Opening After Alarm Keypad Ringback Disabled
2	Opening After Alarm Bell Ringback	ON	Opening After Alarm Bell Ringback Enabled. When the Opening After Alarm reporting code is successfully transmitted to a programmed telephone number, the bell will sound a series of 8 squawks to confirm to the end user that the Opening After Alarm code was sent and received. This ringback will occur for each Opening After Alarm code successfully transmitted.
		OFF	Opening After Alarm Bell Ringback Disabled
3	SIA Reporting Codes	ON	SIA Sends Programmed Reporting Codes. This option is for use with the SIA communication format. If 00 is programmed in the reporting code section, the event will not be communicated. When this option is ON and there is a valid reporting code programmed in the reporting code section, the programmed reporting code will be transmitted. If FF is programmed as a reporting code, the event will not be communicated. Reporting Code Entry Option ON Option OFF 00 No Transmission No Transmission FF No Transmission Auto Reporting Code sent 01-FE 01-FE sent Auto Reporting Code sent
		OFF	SIA Sends Automatic Reporting Codes. When this option is OFF and there is a valid reporting code (01-FE) or FF programmed in the reporting code section, the panel will transmit an automatic reporting code for SIA only. This would be used when automatic reporting codes are required but there is a requirement for a different reporting code (e.g., Pager format, etc.).
4	Closing Confirmation	ON	Closing Confirmation Enabled. When a Closing reporting code is successfully transmitted to a programmed telephone number, the keypad will sound a series of 8 beeps to confirm to the end user that the Closing code was sent and received.
		OFF	Closing Confirmation Disabled. There will be no keypad ringback when a Closing reporting code is successfully transmitted to a programmed telephone number.
5	Talk/Listen Options for Phone Number One/Three	ON	Talk/Listen (PC5936) on Phone #1/3 Enabled. If Talk/Listen is requested for an event by the PC5936, the panel will request the session on the next communication on phone number 1/3 (via L-Block) to the central station.
		OFF	Talk/Listen (PC5936) on Phone #1/3 Disabled. The panel will not request a Talk/Listen session for an event even if the PC5936 has requested it.
6	Talk/Listen Options for Phone Number Two	ON	Talk/Listen (PC5936) on Phone #2 Enabled. If Talk/Listen is requested for an event by the PC5936, the panel will request the session on the next communication on phone number 2 (via L-Block) to the central station.
		OFF	Talk/Listen (PC5936) on Phone #2 Disabled. The panel will not request a Talk/Listen session for an event even if the PC5936 has requested it.

[381] - SECOND COMMUNICATOR OPTION CODES			
Option	Communicator Code	On/Off	Description
7	Contact I.D. Reporting Codes	ON	Contact I.D. Uses Programmed Reporting Codes. The Contact I.D. communications format will use programmed reporting codes when transmitting to the central station.
		OFF	Contact I.D. Uses Automatic Reporting Codes. The Contact I.D. communications format will use the automatic reporting codes as shown in Appendix C when transmitting to the central station.
8	Local Mode	ON	Local Mode Enabled. The panel will always send events to the PC5108L module. Downlook will not be initiated if requested.
		OFF	Local Mode Disabled. The panel will only send events that are being communicated to the PC5108L module. Downlook will be initiated when requested.

[382] - THIRD COMMUNICATOR OPTION CODES			
Option	Communicator Code	On/Off	Description
1	Contact I.D. Partial Closing Identifier	ON	Partial Closing Identifier = 5. Contact I.D. uses 5 as the identifier for the Partial Closing event.
		OFF	Partial Closing Identifier = 4. Contact I.D. uses 4 as the identifier for the Partial Closing event. This option is defaulted OFF.
2	Walk Test Communication	ON	Zone Alarms Communicate during Walk Test Enabled. Zone alarms that occur during Walk Test will communicate if programmed to do so.
		OFF	Zone Alarms Communicate during Walk Test Disabled. Zone alarms that occur during Walk Test will not communicate even if programmed. This option is defaulted OFF. NOTE: This option must be OFF for SIA FAR installations.
3	Communications Cancelled Message	ON	Communications Cancelled Message Enabled. The "Communications Cancelled" (LCD5500Z) or 'CC' (LCD5501Z) message will be displayed if alarms are acknowledged during the Transmission Delay time. This message will be displayed for 5 seconds on all keypads on the partition. The acknowledgment can be from an access code, disarm function key, or a keyswitch zone. Caution: This option must NOT be turned OFF for SIA-FAR installations.
		OFF	Communications Cancelled Message Disabled. The "Communications Cancelled" message will not be displayed. This option is defaulted OFF.
4	Call Waiting Cancel	ON	Call Waiting Cancel Enabled. The Call Waiting dialing string programmed in Section [304] will be dialed before the first attempt of each phone number. All subsequent dialing attempts to the same phone number will not use the Call Waiting Cancel dialing string.
		OFF	Call Waiting Cancel Disabled. The Call Waiting dialing string will not be dialed. This option is defaulted OFF. Note: A Call Waiting Cancel on a non-call waiting line will prevent successful connection to the central station.
5	T-Link	ON	The panel will communicate with a T-Link module connected to the PC-Link header.
		OFF	The T-Link interface is disabled. *NOTE: Not investigated by UL.
6	AC Failure Transmission Delay	ON	AC Failure Transmission Delay. Delay is in hours. NOTE: For central & remote fire applications, this option must be ON.
		OFF	AC Failure Transmission Delay. Delay is in minutes.
7-8		ON	For Future Use

[390]-[393] LINKS Preambles

Downloading can be performed through the LINKS1000 cellular communicator if the telephone line is disconnected. If using the LINKS1000 with Call Back, you need to program the LINKS1000 Preamble with the downloading telephone number in order for the panel to call the computer correctly.

LINKS1000 Cellular Communicator

The LINKS1000 cellular communicator can be used three different ways: as the sole communicator for the panel, as a backup for either or both telephone numbers, or as a redundant backup to the land line communicator (the panel will call both the land line and via the LINKS1000). A **LINKS1000 Preamble** is programmable for each telephone number in the event that the land line number is local but the LINKS1000 is required to dial an exchange. When programming a LINKS1000 Preamble, all unused digits must be programmed with a Hex decimal 'F'.

Sole Communicator

The panel can be programmed to report only using the LINKS1000 cellular communicator when an event occurs. To program this select only the LINKS1000 for the **Communicator Call Direction** Options for the event. In addition the **Call LINKS1000 as well as Land Line** option must also be enabled. When the selected event occurs the panel will only attempt to call the central station using the LINKS1000.

NOTE: If a LINKS1000-only event fails to communicate, the LINKS1000 must successfully communicate a LINKS1000-only event in order for the FTC Trouble to clear.

Backup Communicator

The panel can be programmed to call using the LINKS1000 cellular communicator if the panel is having difficulty communicating an event using the land line. To program this select the telephone number and LINKS1000 options for the Communicator Call Direction Options for the event. The LINKS1000 is backup of Land Lines option must also be selected.

When used as a backup communicator the panel will attempt to call the central station in the following manner:

- the panel will try to call using land lines - if unsuccessful the panel will try to call using the LINKS1000
- if unsuccessful the panel will try to call using the land lines
- if unsuccessful the panel will try to call using the LINKS1000

This process will continue until the panel has successfully communicated with the central station or the **Maximum Dialing Attempts** has been reached.

Redundant Communicator

The panel can be programmed to call using the land line and the LINKS1000 cellular communicator when an event occurs. To program this select both the telephone number

and the LINKS1000 options for the **Communicator Call Direction** Options for the event. In addition the **Call LINKS1000 as well as Land Line** option must be selected. The panel will call the LINKS1000 and then call the land line when reporting the selected event.

LINKS1000 Special Preamble*

In some areas of North America, dialing #DAT or *DATA reduces the cellular billing increment. The **LINKS1000 Special Preamble** (section [393]), allows the use of [*] and [#] characters for the programming of #DAT and *DATA. The LINKS1000 Special Preamble is sent BEFORE the Preamble programmed in Sections [390] to [392]. Example: [Special Preamble][Regular Preamble][Telephone Number].

NOTE: *If this Special Preamble is programmed, it will be inserted before the Regular Preamble of ALL telephone numbers. Hex digits D and E are not supported for Preamble programming. If Busy Tone Detection is enabled, the LINKS1000 must be tested to ensure full operation.*

Refer to the LINKS1000 *Installation Manual* for more information and connection diagrams.

** Do not use this section for Central and Remote Fire Applications.*

.....

(Downloading Telephone Number)	Section [490]
Communicator Call Direction Options	Section [351] to [376]
Call LINKS1000 as well as Land Line	Section [380], Option [7]
Maximum Dialing Attempts	Section [165]

.....

This 4-digit number can be used with long distance telephone numbers that are dialed through the LINKS module. These codes are used for programming area codes in cases where a land line telephone number may be a local call, while the cellular telephone number dialed by the LINKS module is a long distance call.

[393] - LINKS Special Function Preamble

This Special Preamble is inserted before all other preambles. It is used for dialing such cellular numbers as #DAT and *DATA for reduced billing increments.

5.7 Downloading Options PWS Sect 7

Downloading

Downloading allows programming of the entire control panel via a computer, modem and telephone line. All functions and features, changes and status, such as Trouble conditions and open zones can be viewed or programmed by downloading.

NOTE: *When power is applied to the panel, a 6-hour downloading window can be enabled. This will allow you to perform downloading without having to do any keypad programming.*

NOTE: *When an event occurs that the system is programmed to communicate to the central station, the panel will disconnect from the downloading computer and report the event. This will happen for all events except test transmissions.*

If the **Answering Machine/Double Call** option is enabled (or during the first 6 hours after power up) the panel will answer incoming calls for downloading provided the following conditions occur:

1. The panel hears one or two rings, then misses a ring.
2. At this point the panel will start a timer.
3. If the panel hears another ring before the **Answering Machine Double Call Timer** expires it will answer on the first ring of the second call.

The panel will immediately go on-line and begin the download process unless the **Call Back** option is enabled. If enabled, the panel and computer will both hang up. The panel will then call the **Download Computer Tele-**

phone Number and wait for the computer to answer. Once the computer answers downloading will begin.

If the **User-enabled DLS Window** option is ON, the user can activate the downloading feature by entering [*][6][Master Code][5].

Six hours after power-up, the panel will not answer incoming calls unless the **Answering Machine/Double Call** option is enabled, or the **Number of Rings** is programmed to be more than [0].

If the **User-Initiated Call-Up** option is enabled, the user can have the panel initiate a call to the downloading computer by pressing [*][6][Master Code][6].

The **Download Access Code** and **Panel Identifier Code** are for security and proper identification. Both the panel and the computer file should have the same information programmed before attempting to download.

The time to complete a successful download can be significantly reduced with the use of the PC-Link. This adaptor makes it possible to perform on-site downloading. To **Initiate Local Downloading via the PC-Link**, enter [*][8][Installer Code] [499] [Installer Code] [499]. All keypads will be busy for the duration of the PC-Link connection. The status LEDs will display the current system status on the keypad where the PC-Link was initiated. For more information on connecting the PC-Link, refer to your 'PC-Link Download Kit Instruction Sheet'.

Downloading can also be performed through the LINKS1000 cellular communicator if the telephone line is disconnected. If using the LINKS1000 with Call Back, you need to program the **LINKS1000 Preamble** with the downloading telephone number in order for the panel to call the computer correctly.

NOTE: *When uploading labels from LCD keypads, the DLS software will receive the labels only from the LCD keypad assigned to slot 8. In addition, version 1.0 and version 2.0 LCD keypads are not compatible on the same system. For more information refer to the Download Manual included with the computer software.*

NOTE: *The most recent version of the PKP-LCD keypad on the system should be assigned to slot 8.*

.....

Answering Machine Double Call Timer	Section [405]
Download Computer Telephone Number	Section [402]
Download Access Code	Section [403]
Panel Identifier	Section [404]
LINKS1000 Preamble (Downloading)	Section [490]

.....

[401] - First Downloading Option Codes			
Option	Downloading Code	On/Off	Description
1	Downloading Answer	ON	Downloading Answer Enabled. The system will answer calls for downloading if a successful Double call routine is detected. Have the downloading computer call the system and let the telephone line ring once or twice. After 1 or 2 rings, hang up. If called back within the programmed Double Call Time (000-255 seconds), the panel will answer on the first ring.
		OFF	Downloading Answer Disabled. The system will not answer incoming calls using the Double Call routine unless the User enables the DLS window. This option can be enabled by turning Option 2 ON.
2	DLS Window	ON	User Can Enable DLS Window. The user can use the [*][6][Master Code][5] command to enable a 6-hour window in which the panel will answer calls for downloading if a successful Double Call routine is detected. If this option is enabled, the window is open upon power-up. The window is on for the full 6 hours if enabled.
		OFF	User Can Not Enable DLS Window. The user can not enable a window for DLS calls. NOTE: Options 1 and 2 are not related. One does not need to be enabled for the other to perform its function.
3	Call-Back	ON	Call-Back Enabled. When the system answers the downloading computer's call, both the computer and the panel will hang up. The panel will then call the Downloading Telephone Number and connect with the computer at that number. If more than one downloading computer is to be used, this function should be disabled.
		OFF	Call-Back Disabled. The downloading computer will have immediate access to the panel once it is identified as a valid system.
4	User Call-Up	ON	User Call-Up Enabled. When this feature is enabled, the user may initiate a single call of the Downloading Telephone by entering [*][6][Master Code][6].
		OFF	User Call-Up Disabled. An error tone will be generated when [*][6][Master Code][6] is entered.
5-8			For Future Use

NOTE: To perform downloading via the T-Link module, Option [1], Section 401 must be enabled or the number of rings in section 406 must be programmed.

NOTE: Option [2] applies to DLS via T-Link as well. Options [3] and [4] cannot be performed through T-Link.

[402] - Downloading Computer's Telephone Number
This telephone number is 32 digits in length.

[403] - Downloading Access Code
This 4-digit Hexadecimal code allows the panel to confirm that it is communicating with a valid downloading computer.

[404] - Panel Identification Code
This 4-digit Hexadecimal code allows the downloading computer to confirm the identity of the control panel.

[405] - Double-Call Timer
This timer sets the amount of time that can be taken between calls when using Double Call to contact the panel.
Valid entries are 001 to 255 (seconds).

[406] - Number of Rings to Answer On
The value in this section determines how many rings that the panel will automatically pick up on in order to establish a DLS connection. Default value is 000 rings. Valid entries are [000]-[020].

NOTE: If Section [401] Option 1 and Section [406] are enabled, either one will work depending on how the installer calls the premises.

[490] - LINKS DLS Phone Number Preamble
Refer to Section [390].

[499] - Initiate PC-LINK Communications
The installer may initiate a PC-Link DLS session between a computer and panel by entering this section in the following manner:
[499] - [Installer Code] [499].

The installer should already have the PC-Link cable properly connected between the panel's header and the downloading computer as well as have the DLS file waiting for the panel to connect before entering this command.

NOTE: PC-Link cannot be initiated while the panel is communicating via the phone line.

5.8 Programmable Output Programming PWS Sect 8

[501]-[515] - Programmable Output Attributes
PGM output attributes and output type must be programmed for each PGM output. PGM output options [09] System Trouble and [10] Latched System Event have a unique set of attributes listed below the description of each output type.

PGM attributes return to their default settings when PGM output options are changed. See the *Programming Worksheets* for a list of the default settings for each PGM output type.

CAUTION: Select the normal and active states of each PGM output to ensure that undesirable output states do not occur after a loss and restoral of AC power.

If you program more than one PGM output as the same output type (e.g., If PGM 1 and PGM 2 are both programmed as [19] Command Output 1), the settings for output attributes [1], [2] and [5] must be the same. This does not apply to outputs programmed as types [09] and [10].

NOTE: Attribute [3] must be ON for PGM output option [16].

Assigning Partitions to Programmable Outputs

By default, all programmable outputs are assigned to partition 1. For programmable outputs to work on other partitions, enable or disable the appropriate partitions in the Partition Assignment programming sections.

PGM Output Partition Assignment	Sections [551] - [564]
PGM Output Timer	Section [170]

[501]-[515] PROGRAMMABLE OUTPUT ATTRIBUTES			
PGM Output Types [01], [03], [04], [05]-[08],[12],[13],[14],[15],[17],[18] and [25]			
1	Not Used		NOTE: This option must be off to ensure proper PGM operation.
2	Not Used		NOTE: This option must be off to ensure proper PGM operation.
3	Output Level	ON	The output will activate (switch to Ground) when the event occurs.
		OFF	The output will de-activate (switch to open) when the event occurs.
PGM Output Types [03], and [19]-[22]			
4	Output Options	ON	Output Pulsed. The output will activate for the duration programmed in for the PGM Output Timer in Section [164]. This default period is five seconds.
		OFF	Output On/Off. The output will toggle between on and off when the corresponding [*][7] command is entered.
PGM Output Types [19]-[22].			
5	Access Code Options	ON	Access Code Required for Activation.
		OFF	No Access Code Required for Activation. Attribute 3 is available for all Output types.
PGM Output Types [09] System Trouble			
1	Service Required		
2	AC Fail		
3	Telephone Line Fault		
4	Communications (Failure)		
5	Zone (Fire) Fault		
6	Zone Tamper		
7	Zone Low Battery		
8	Loss of Clock		
PGM Output Types [10] System Event			
1	Burglary		Delay, Instant, Interior, Stay/Away, and 24-hr Burg Zone Types
2	Fire		[F] Key, Fire Zone
3	Panic		[P] Key and Panic zones
4	Medical		[A] Key, Medical and Emergency zones
5	Supervisory		Supervisory, Freeze and Water zones
6	Priority		Gas, Heat, Sprinkler and 24-hr Latching Tamper zones
7	Holdup		Holdup Zones and Duress Alarms
8	Output Options	ON	Output Follows PGM Timer. The output will activate for the period of time programmed for the PGM Output Timer.
		OFF	Output is Latched. The output will be active until a valid access code is entered. NOTE: If a System Event PGM is programmed to follow the Command Output Timer, all attributes must be enabled. NOTE: These are the attributes available for the System Event PGM option. The output will activate if any of the corresponding alarm types occur on the system.

[551]-[564] PGM Partition Assignment

The PC5020 has an 8-bit toggle field per output that determines which partitions the output is assigned to (outputs PGM 1-14). Each bit corresponds to a partition in each PGM's toggle mask. This field is supported by PGMs that have multiple partition capabilities (i.e., Command Outputs, Away Arming) It does not affect system outputs (e.g., Ground Start Pulse).

NOTE: For PGM output types 19-22, for any PGM output programmed as the same type, use the attributes and partition assignments of the lowest PGM.

NOTE: PGM Output Types 09-16, 23 and 24 do not use the PGM Partition Assignment Mask.

5.9 International Programming PWS Sect 9 [700] - Automatic Clock Adjust

The value entered here adds or subtracts seconds at the end of each day to compensate for crystal/ceramic reso-

nator inaccuracies. Valid entries are 00-99 with 60 seconds being the default minute. To determine the value to be programmed in this section perform the following:

- Monitor the time lost by the panel over a period of time.
- Calculate the average amount of time per day that the panel gains or loses.
- Add or subtract this value (seconds) from 60 and enter the value.

Example: panel loses an average of 9 seconds per day. Instead of loading 60 seconds for the last minute of each day, program the panel to load 51 seconds with the use of Section [700]; this will speed up the panel by 9 seconds everyday.

[701] FIRST INTERNATIONAL OPTION CODES			
Option	International Code	On/Off	Description
1	AC	ON	50 Hz AC. - The incoming AC power cycles at 50 Hz.
		OFF	60 Hz AC. - The incoming AC power cycles at 60 Hz.
2	Time Base	ON	The timebase is the internal crystal oscillator. In cases of unstable AC power input, the internal crystal can be used to keep the most accurate timebase.
		OFF	The timebase is the AC power input. The 50 or 60 Hz AC power input is normally very stable and can be used as the timebase

[701] FIRST INTERNATIONAL OPTION CODES			
Option	International Code	On/Off	Description
3	Arming Inhibit	ON	AC/DC Arming Inhibit with Battery Check Enabled. When an AC or DC Trouble is present, the system will not arm. This includes Keypad, Keypad, Automatic, and Downloading arming. If enabled and arming is attempted, the system will perform a system battery check as well as a battery check on all peripheral modules supported by a backup battery.
		OFF	Arming not Inhibited. The system can be armed, regardless of the presence of an AC or DC Trouble and will not check all system batteries upon arming. NOTE: If this option is enabled, it is strongly recommended that AC Troubles be displayed (Section [017], Option 1 ON).
4	Latching System Tamper	ON	System Tamper Require Installer Reset and Inhibit Arming If any system Tamper condition occurs, the Installer Code must be entered [*][8] [Installer Code] and the Tamper condition must be restored before the system can be armed. This includes Auto-arming and keyswitch. If Auto-arming is attempted with a latched tamper, the panel will not arm. The Auto-arm cancellation code is not transmitted however because a user did not cancel the Auto-arming sequence.
		OFF	System Tamper Do Not Require Installer Reset. If enabled, the manual bypassing of a zone will not bypass the tamper or fault states (DEOL). This feature also applies to Zone Faults.
5	Access Code Length	ON	6-digit Access Codes. All access codes on the system will be 6 digits in length except the Panel I.D. Code and the Downloading Access Code. <ul style="list-style-type: none"> System Master Code = XXXX56 XXXX = previous code, (1234) Installer Code = YYYYY5 YYYYY = previous code, (5555)
		OFF	4-digit Access Codes. All access codes on the system will be 4 digits in length. For any existing codes, the last 2 digits are removed.
6	Busy Tone	ON	Busy Tone Detection Enabled. If these tones are detected, the communicator will disengage the phone line and try to place the call again following the Delay Between Dialing Attempts.p
		OFF	Busy Tone Detection Disabled. The communicator will use the standard dialing procedure for every attempt.
7	Battery Current Charge	ON	High Current Battery Charge. Approximately 650-700 mA.
		OFF	Standard Current Battery Charge. Approximately 350 mA.
8		ON	For Future Use

[702] SECOND INTERNATIONAL OPTION CODES			
Option	International Code	On/Off	Description
1	Pulse Dial	ON	Pulse Dialing Make/Break Ratio is 33/67
		OFF	Pulse Dialing Make/Break Ratio is 40/60
2	Force Dial	ON	Force Dialing Enabled. If the first attempt by the panel to call the monitoring station fails to detect a dial tone, on every subsequent attempt the panel will dial regardless of the presence of dial tone. See {703} Delay Between Dialing Attempts
		OFF	Force Dialing Disabled. The panel will not dial the programmed telephone number if dial tone is not present.
3	Land Line Test Transmission	ON	Land Line Test Transmission Interval is in Minutes. The value programmed in Section [370] seventh entry is in minutes.
		OFF	Land Line Test Transmission Interval is in Days. The value programmed in Section [370] Seventh entry is in days. NOTE: This option must be OFF for the PC5020CF.
4	Handshake	ON	1600 Hz Handshake. The communicator responds to a 1600 Hz handshake for bps formats.
		OFF	Standard Handshake. The communicator responds to the handshake designated by the format selected (1400 or 2300 Hz).
5	I.D. Tone	ON	I.D. Tone Enabled. After the telephone number is dialed, the panel will emit a tone (as specified by Option 6) for 500ms every 2 seconds to indicate that it is a digital equipment call, not voice.
		OFF	I.D. Tone Disabled.
6	I.D. Tone Frequency	ON	2100 Hz I.D. Tone
		OFF	1300 Hz I.D. Tone
7	DLS Window	ON	One Time 1-hour User-enabled DLS Window. The user-enabled DLS Window is 1 hour in length and will be closed after a successful hang-up from a downloading call.
		OFF	Full 6-hour User-enabled DLS Window. The user-enabled DLS Window is 6 hours in length and remains open after a successful hang-up from a downloading call. This option determines the length of the DLS window available on power up.
8	FTC Bell	ON	Bell on FTC when armed. If a Failure to Communicate Trouble is generated while the system is armed, the Bell output will sound for the length of Bell time-out or until the system is disarmed.
		OFF	FTC Trouble only when armed. If a Failure to Communicate Trouble is generated while the panel is armed, the Bell output will not sound but the keypad buzzer will sound Trouble beeps until a key is pressed.

[703] - Delay Between Dialing Attempts

For standard (force) dialing, the panel will go off-hook, search for dial tone for 5 seconds, hang-up for 20 seconds, go off-hook, search for dial tone for 5 seconds, then dial. If there is no initial handshake recognized within 40 seconds, the panel will hang up. This programmable timer

adds a delay before the next call is attempted, and is defaulted to 001 for a total of six seconds.

5.10 Module Programming PWS Sect 10

The programming sections listed below pertain to additional modules on the system. For instructions on programming these modules and a description of each programming section, see the associated *Installation Manuals*.

1. PC5400 Programming Section [801]
2. PC5936 Programming Section [802]
 - PC5936 audio interface will allow you to connect to 16 Interior (PC5921) or exterior (PC5921EXT) Intercom Station. These surface mounted stations contain a speaker and a microphone. This module enables Page/Answer, Do Not Disturb, Baby Monitor, Answer Incoming Calls, Doorbell Function, and Background Music features in your alarm. This module also has the Listen-in feature for central station monitoring. The central station can select the audio station, listen/talk, extend on-line time and hang up. The Listen-In feature can be enabled separately for telephone numbers 1/3 and 2. *All Talk/Listen and/or video sessions will be disconnected if the panel needs to communicate alarms to the central station.*
 - Alternate Communicator Programming Section [803]
 - PC5132 Programming Section [804]
 - PC5100 Programming Section [805]
 - PC5108L Programming Section [806]

NOTE: All Talk/Listen and/or video sessions are disconnected when the panel communicates alarms to the central station.

- T-Link Programming Section [851]

NOTE: Option [5] in Section [382] must be enabled to access this section.

The T-Link module can be used to communicate panel events in SIA format over a Local Area Network (LAN). It can also be used for downloading (this requires DLS-3 v1.3).

 Telephone 1 & 3 Listen-In Enabled Section [381], Option 5
 Telephone 2 Listen-In Enabled Section [381], Option 6

Periodic Camera Test

When the **Periodic Camera Test** option is enabled, the panel will test cameras connected to a PC5108L module every 30 minutes. Only cameras with the Camera Test option enabled will be tested. See your *PC5108L Installation Manual* for more information on camera tests.

If the **Local Mode** option is ON, the panel will send events to the PC5108L module, Downlook will not be initiated if requested. If the Local Mode option is OFF, the panel will send communicated events to the PC5108L module. Downlook will initiate when requested. See your *PC5108L Installation Manual* for more information. See Periodic Camera Test Section [017], Option [7] and Local Mode Enabled/Disabled Section [381], Option [8]

5.11 Special Installer Instructions PWS Sect 11

[901] - Installer Walk Test Mode Enable / Disable

The **Installer Walk Test** can be used to test the alarm state of each zone of the panel. The Walk Test cannot be used to test zone type [24]. Before beginning the Walk Test, ensure the following conditions are met:

1. The panel is disarmed
2. The Keypad Blanking option is disabled (section [016]: [3])
3. The Fire Bell is Continuous option is disabled (section [014]: [8])
4. The Transmission Delay is disabled, if Transmission Delay is not required (section [377])

NOTE: Fire Troubles are not supported in Walk Test. All outputs will activate for all partitions during the Walk Test, regardless of programming.

To perform a Walk Test, do the following:

1. Enter Installer Programming
2. Enter Section [901]

When any zone is violated the panel will activate the Bell Output for two seconds and log the event to the event

buffer. Check the event buffer to ensure that all zones and FAP keys are functioning properly.

NOTE: If there is no zone activity on the system for 15 minutes, the system will end the Walk Test and return to the normal state.

To stop the test, you must do the following:

1. Enter Installer Programming
2. Enter Section [901]

Zones do not have to be restored to stop the test. After the test is complete, check the event buffer to ensure that the Audible/Silent 24-Hr. PGM alarms have been restored.

NOTE: The Alarm Memory is cleared upon entering Walk Test mode. When the Walk Test is complete, the Alarm Memory will indicate the zones tested. The Alarm Memory will be cleared the next time the panel is armed.

NOTE: While the Walk Test is in progress, all three LEDs (Ready, Arm, Trouble) will flash at a rapid rate. At the start of the Walk Test, a TS signal will be communicated. When the test is stopped a TE (test end) is communicated.

[902] - Reset Module Supervision

All modules will automatically enroll within one minute upon power up (except the PC5132 if there are no serial numbers programmed). If modules are to be removed, this section should be entered after the removal of the modules so that it can clear any supervisory Troubles that may be present. When this mode is entered, the system will re-evaluate the components of the system.

NOTE: It may take up to a minute to enroll or delete a module. Before entering Section [903] to view the module field, this time should be taken into account.

If there is a module that is not properly communicating with the system and this section is entered, the module will be deleted from the system.

Once executed, all pending Supervisory Trouble Restorals will not be logged or transmitted.

[903] - Module Supervision Field

When this mode is entered, the system will display all of the modules presently enrolled on the system as indicated below.

[903] MODULE SUPERVISION FIELD	
Indicator	Module
Lights 1-8	Keypads 1-8
Lights 9-14	Zone Expander Groups 1-6
Light 15	PC5100
Light 16	Zone Expander Group 7
Light 17	PC5132
Light 18	PC5208
Light 19	PC5204
Light 20	PC5400
Light 21	PC59XX
Light 22	Alternate Communicator
Light 23	Downlook Module
Light 24	Escort5580(TC)
Light 25	For Future Use
Light 26-29	PC520X1-4

[904] - Module Placement Test

Module Selection

Upon entering Section [904], a 2-digit entry will be required to select the zone number to be tested. Valid entries are 01-32 for Zones 01-32 respectively. On an LCD keypad, there are two ways to make a zone selection: direct entry of 01-32, or by scrolling across to the description of the module (i.e. 'Zone 1'). If a module is selected that is not enrolled, an error tone will sound.

Placement Indication

After the zone is selected, the alarm contacts must be opened. This will register a signal strength value that will be indicated and announced on all keypads, as well as on the bell. The system will remain in this test mode until [#] is pressed or Installer Time-out (20 minutes).

- **GOOD** signal will be indicated by Light 1 on an LED keypad or the word GOOD on an LCD keypad. It will be announced on the Keypad by 1 beep and on the Bell by 1 Squawk.
- **FAIR** signal will be indicated by Light 2 on an LED keypad or the word FAIR on an LCD keypad. It will be announced on the Keypad by 2 beep and on the Bell by 2 Squawk.
- **BAD** signal will be indicated by Light 3 on an LED keypad or the word BAD on an LCD keypad. It will be announced on the Keypad by 3 beep and on the Bell by 3 Squawk.
- Non-Enrolled zone will be announced on the Keypad by an error tone.

[906] - Local Downlook Remote Trigger

While in this section, either 1 or 2 can be pressed to initiate Downlook to either phone number 1 or 2, respectively. The panel will communicate the System Test event, log 'Downlook Remote Trigger', and transmit the script found in the PC5108L for Remote Trigger.

[990][Installer Code] - Installer Lockout Enable

If enabled, the panel will give a distinctive audible indication on power up (the phone line relay will click 10 times). This feature will have no effect on a Software Default (all programming will return to the factory defaults). However, if a Hardware default is attempted while lockout is enabled, the default will not occur, and the fraudulent attempt will be logged to the event buffer.

Installer Lockout

If **Installer Lockout** is selected a hardware default cannot be performed. If a software default is performed all programming will restore to factory default.

When **Installer Lockout Disable** is selected the panel will restore all programming to factory defaults if a hardware or software default is performed on the main control panel.

To enable Installer Lockout perform the following:

1. Enter Installer Programming.
2. To enable Installer Lockout, enter section [990]
3. Enter the Installer Code.
4. Enter section [990] again.

[991][Installer Code] - Installer Lockout Disable

This disables the Installer Lockout feature described above.

To disable Installer Lockout perform the following:

1. Enter Installer Programming.
2. To disable Installer Lockout, enter section [991].
3. Enter the Installer Code.
4. Enter section [991] again.

[993]-[999] Factory Defaults

On occasion it may be necessary to default the main control panel or one of the modules that can be connected. There are several different defaults available including defaulting the main control panel, Escort5580(TC) module, PC5132 wireless expander module, PC5400 printer module and LINKS2X50 module.

NOTE: Defaulting the main panel does not default the keypads. See the Programming Worksheets Appendices A and B for instructions for defaulting LCD5500Z/LCD5501Z keypads. PC55XXZ LED keypads must be manually reprogrammed in programming section [000].

Factory Default Main Panel (Hardware)

1. Remove AC and battery power from the panel.
2. Remove all wires from the zone 1 and PGM1 terminals.
3. With a piece of wire short the zone 1 terminal to the PGM1 terminal.
4. Apply AC power to the main panel.
5. When zone light 1 is lit on the keypad the default is complete.
6. Remove AC power from the control
7. Reconnect all original wiring and power up the control.

NOTE: AC power must be used to power the panel. The panel will not default if the battery is used.

Factory Default Main Panel (Software) and other modules

1. Enter Installer Programming.
2. Enter the appropriate programming section [99X].
3. Enter the Installer Code.
4. Enter the appropriate programming section [99X] again. The panel will take a few seconds to reset. When the keypad is operational, the default is complete.

[993][Installer Code] - Restore Alternate Comm. Factory Default Programming

When this section is successfully entered, all programming for the Alternate Communicator (LINKS2150, LINKS2450, LINKS3000, or PC5400 DVACS module) will be returned to the factory defaults.

[994][Installer Code] - Restore PC5100 2-Wire Addressable Device Interface Factory Default Programming

When this section is successfully entered, all programming in the PC5100 2-wire addressable device interface module will be returned to the factory defaults.

[995][Installer Code] - Restore Escort5580(TC) Factory Default Programming

When this section is successfully entered, all programming for the Escort5580(TC) module will be returned to the factory defaults.

[996][Installer Code] - Restore PC5132 Wireless Factory Default Programming

When this section is successfully entered, all programming in the PC5132 wireless expansion module will be returned to the factory defaults.

[997][Installer Code] - Restore PC5400 Factory Default Programming

When this section is successfully entered, all programming in the PC5400 serial module will be returned to the factory defaults.

[998][Installer Code] - Restore PC59XX Factory Default Programming

When this section is successfully entered, all programming in the PC59XX audio matrix module will be returned to the factory defaults.

[999][Installer Code] - Restore Factory Default Programming

When this section is successfully entered, all programming for the PC5020 will be returned to the factory defaults. The programming for the Escort5580(TC), PC5132, PC5400 and PC59XX modules will not be defaulted. When this command is executed, the module supervision field will be reset.

Section 6: Central & Remote Station Fire Installation Instructions

6.1 Introduction

The PC5020CF is a UL/ULC Listed panel for [1] Central & Remote Station Fire Monitoring [2] Local & Central Station Burglary Alarm Monitoring. When used for fire monitoring, all fire functions **must** be configured to take priority over Burglary and other auxiliary functions.

The PC5020CF has a number of system functions established as default values. These functions must be maintained to ensure the Life-Safety integrity of the installation meets all applicable codes and standards.

To ensure an appropriate installation, all applicable NFPA and local codes and standards should be reviewed. The local AHJ (Authority Having Jurisdiction) should also be consulted prior to installation to determine specific local requirements for a fire alarm installation.

Information in this manual is intended to describe the fire functionality of the equipment. Further information on the overall system is contained in the companion manuals for this product and must be consulted for a full understanding of operation, installation and programming.

This manual lists a number of alarm initiating and alarm notification devices for use with this equipment.

6.2 Hardware Description and Specifications

PC5020CF - Main Panel

- One PC4050CR cabinet 14.8" x 12.0" x 4.9" with space for two 12V, 7Ah sealed lead-acid rechargeable batteries
- One PC5020 main control module which includes:
 - 8 zones programmable for Fire or Burglary
 - Programmable outputs:
 - 12 VDC, 50 mA max. each (standard output) (PGM 1, 3, 4) or
 - 12 VDC, 300 mA max. each (smoke detector capability)(PGM 2)
 - One unswitched AUX power supply – 12 VDC, 420 mA max.
 - One supervised bell circuit – 12 VDC, 700 mA max.
 - Supervised battery charger – 12 VDC, 360 mA charging current max.
 - Supervised telephone communicator (connects to PC5700 module)
- Tamper kit T-1
- One power transformer – 16.5 VAC, 37 VA minimum
- One hardware package which includes:
 - 16 EOL resistors (5,600Ω)
 - One black cabinet plug
 - One green grounding strap
 - Mounting hardware for the PC5020CF PCB
 - One EOL resistor (2200Ω)
 - One (1000Ω) resistor for bell supervision

Minimum System Requirements for Commercial Fire Applications

PC5020 CF System Components:

Central Station Fire Monitoring Service

- PC5020 control unit
- PC4050CR/PC4050CRAR enclosure
- PC5700 fire module (dual dialer) or T-Link Communicator (TCP/IP)
- LCD5500Z keypad

Remote Station Fire Monitoring Service

- PS5350 external battery charger

NOTE: This unit must be used with all the components listed for central station fire monitoring service.

6.3 Compatible Devices

PC5700 Fire Module (150mA max. current draw)

- Two waterflow zones – Class 'A'
- Two supervised communicator outputs
- Terminal connections for local telephone
- Hardware to mount the module to the side wall of the PC4050CR/PC4050CRAR enclosure

LCD5500Z Fire Keypad (85mA max. current draw)

Standard LCD keypad (red bezel optional) for use with the PC5020 CF.

NOTE: At least one LCD5500Z keypad must be used with the PC5020CF and should be installed close to the panel.

T-Link Local Area Network Communicator

The T-Link Local Area Network Communicator provides an efficient method of communicating via a Local Area Network (LAN). See the T-Link *Installation Manual* for more details.

Compatible Smoke Detectors

Please see the 2-wire Smoke Detector Compatibility Chart (below) for a list of 2-wire smoke detectors that have been listed as compatible with the PC5020CF two-wire smoke detection zone (PGM2).

Name	Model	Compatibility ID	Max #	Base
DSC	MN220, -R, -T, -RT	PS-220	30	None
System Sensor	2100AT,	A	30	None
	2100TR	A	30	None
Sentrol	429AT or 521B/BXT SW1 on	S09A	30	None
	400 series, 429C, 429CT	S10A	30	None
	429CST, 429CRT, 429CSST	S11A	30	None
	521CRXT	S11A	30	None
	521B, 521BXT SW1 off	S10A	30	None
	711U/UT, 712U, 721U/UD/UT	S10A	30	None
	713-5U, 713-6U, 722U	S10A	30	None
	731U, 731UD, 732U	S11A	30	None

PS5350 - External Battery Charger (For remote station fire monitoring)

- PC4055C beige or red cabinet
- PS4085 multi-rate charger module
- Transformer, 12VAC, 80 VA
- Space for 60Ah, 12V sealed lead-acid battery

Section 7: Fire Monitoring Zone Types

This section explains all Fire monitoring zones that can be programmed on the PC5020CF and PC5700 fire module. Fire monitoring zone programming is the same as burglary zone programming. Instructions on zone programming are located in the PC5020 *Installation Manual*, see Partitions and Zones.

NOTE: 2-wire smoke detectors can only be connected to the dedicated 2-wire smoke zone on the PC5020CF, PGM2 and Aux+ terminals.

7.1 Partitions and Fire System Configuration

A fire system within a single building must not be partitioned in such a way that audible or visual alarm notification appliances would operate in one partition and not another.

Even though the system can be partitioned for security control purposes, any fire zone on any partition in the building must activate all fire monitoring zones in all system partitions.

The PC5020CF provides two methods for achieving these results.

Fire Configuration 1

- Assign all fire monitoring zones to one partition.
- Assign at least one keypad to the same partition as the fire monitoring zones.
- Other types of zones can also be assigned to this partition without affecting the fire operation as described below.

Operation

The waterflow and any fire monitoring zones on the PC5700 module will show, in the auto-scroll mode, on all partition and global keypads. If a zone on the PC5700 is in alarm, then fire silence and reset can be done from any partition keypad.

If the alarm is from a partition zone then fire alarm silence and reset can only be done directly on the fire partition keypad(s). To silence from other partition keypads or a global keypad requires that the keypad be loaned to the fire partition.

Fire Configuration 2 (Recommended)

- Assign ALL fire zones to ALL active partitions in the system. Do not program fire zones as 'silent'.
- One or more keypads can be located on any partition.

Operation

On alarm, the auto-scroll display will show on all partition keypads.

Fire alarm silence and fire system reset may be done directly on *any* partition keypad. To silence from a global keypad requires that the global keypad be loaned to one of the partitions.

NOTE: Assign command output 2 (sensor reset) to all partitions.

7.2 Fire Zones

All zones can be programmed as Fire Monitoring zones. This zone is always an end of line resistor type with normally open alarm contacts from the alarm initiating device(s). Multiple devices can be connected in parallel on a single zone.

The zone wiring is supervised by the control panel for:

- Short Circuit: Fire Alarm
- Open Circuit: loss of the end of line resistor; this will be indicated as a Zone Trouble
- Ground Fault: resistance < 40k Ω to earth ground indicated as a Ground Fault Trouble on PC5700 zone 7

Typical Fire Devices used on this zone type are:

- Heat Detectors – fixed temperature and/or rate-of-rise
- Fire alarm panel outputs such as Alarms and Troubles
- Manual pull stations
- 4-wire smoke detectors

Standard Fire Operation

When a Fire Monitoring zone goes into alarm, the panel will activate the alarm notification output(s) and will immediately transmit a reporting code to the central station, if programmed. The alarm notification output(s) can be programmed to pulse—one second on, one second off—or to follow another programmed alarm notification pattern (see Section 5.3, 'Basic Programming', [005] System Times). If an open condition is present, the panel will immediately display and communicate a Trouble condition. All keypads will annunciate the Trouble by activating the Trouble light and beeping twice every ten seconds. The keypads can be silenced by pressing any key.

7.3 Auto Verify Fire

All zones can be programmed as Auto Verify Fire zones. For zones on the main panel or zone expanders, this zone is always an end of line resistor type with Normally Open alarm contacts from the alarm initiating device(s). Multiple devices can be connected on a single zone.

The zone wiring is supervised by the control panel for:

- Short Circuit: Fire Alarm
- Open Circuit: loss of the end of line resistor; this will be indicated as a Zone Trouble
- Ground Fault: resistance < 40k Ω to earth ground indicated as a Common Ground Fault Trouble.

NOTE: This zone type is *only* for smoke detectors that can be reset by the control panel. Do not mix contact type alarm-initiating devices on zones programmed for Auto Verify Fire. The following device can be used:

- 4-wire smoke detectors powered from the AUX+ output on the PC5020CF main board

7.4 Waterflow Zone

This type is a Contact Input Fire Zone and is always an end of line resistor type with normally open alarm contacts from the initiating device(s) when used on the PC5020CF (zones 1-8) or zone expander on-board zones. A maximum of five waterflow contacts can be connected in parallel on a single waterflow zone.

The zone wiring is supervised by the control panel for:

- Short Circuit: Fire Alarm
- Open Circuit: loss of the end of line resistor and will be indicated as a Zone Trouble
- Ground Fault: resistance < 40k Ω to earth ground indicated as a Common Ground Fault Trouble.

Typical alarm initiating devices used on this zone type are waterflow switches for fire suppression sprinklers

NOTE: For this type of zone, only waterflow alarm-initiating devices can be connected. A maximum of five (5) waterflow alarm-initiating devices is allowed per zone (Ref: NFPA 72 / 5-6 and 3.8.5).

7.5 PC5700 Zones

PC5700 Waterflow

The waterflow zones on the PC5700 are hardcoded for waterflow operation and cannot be reprogrammed.

If waterflow zones are used on the PC5020CF, the PC5700 waterflow zone must be used. This zone is a normally closed loop between A+ and A- and B+ and B- (class A) with normally open alarm contacts from the waterflow alarm-initiating devices. As per NFPA, only five waterflow initiating devices may be connected to a single zone.

The zone wiring is supervised by the control panel for:

- Short Circuit: Fire Alarm
- Open Circuit: If either the A or B loop is open, this will be indicated as a Zone Trouble (zone fault)
- Ground Fault: resistance < 40kΩ to earth ground indicated as a Common Ground Fault Trouble.

7.6 Four-Wire Smoke Detector Zones

All zones (except for waterflow zones) can be programmed for 4-wire smoke detectors. It is always an end of line resistor type with normally open alarm contacts from the fire alarm-initiating devices. Multiple contacts can be connected in parallel on a single zone.

For commercial applications, zones used for 4-wire smoke detectors can be programmed as Standard Fire. For residential applications, the zone can be programmed as Standard Fire.

Power for the 4-wire smoke detectors can be derived from the auxiliary (AUX+) output on the PC5020 CF main panel. This detector may be connected to any PGM 1-4. The PGM must be programmed as Sensor Reset (see *Programming Worksheets*). PGM2 can either be programmed for a 2-wire smoke detector or a 4-wire smoke detector, but both detectors cannot be programmed concurrently on PGM2. For a wiring diagram, see Appendix B-6 'Sensor Reset for 4-Wire Smoke Detectors'.

7.7 Two-Wire Smoke Detector Zones

PGM2 can be programmed for 2-wire smoke detectors. More than one smoke detector can be connected in parallel, refer to the Compatibility Chart in this manual for details (see section 6.3). For installations of these devices, refer to wiring diagram B.1, see Appendix B. PGM2 must be programmed for 2-wire smoke support (PGM2 only) Option[4]. Refer to the PC5020 CF *Programming Worksheets*, 'Programmable Output Options'.

7.8 Fire Supervisory Zone

This zone is always an end of line resistor type with normally open alarm contacts from the Fire Supervisory initiating devices. A maximum of 20 Fire Supervisory devices can be connected in parallel on a single zone. The zone wiring is supervised by the control panel for:

- Short Circuit - Supervisory off-normal
- Open Circuit - loss of the end of line resistor; this will be indicated as a Zone Trouble

A Fire Supervisory zone monitors fire critical systems to indicate when those systems are in a condition that could prevent normal operation. These most commonly monitored devices are sprinkler gate valves to ensure they are not closed, which would prevent water from flowing to the sprinklers.

Section 8: Fire System Operation

8.1 Manual Signal Silence

Once the panel is in alarm and the alarm notification appliances are active, entering a valid user code will silence the alarm signals.

Silencing will not deactivate any output programmed as Fire Strobe.

Manual Silencing initiates a Trouble condition by turning on the keypad Trouble LED and sounding the keypad buzzer. The buzzer may be silenced by entering an access code.

If a waterflow alarm is present on the system silencing will not be possible. Instead, the system will announce, 'Silence Inhibit, Waterflow Alarm'. All waterflow zones must be secured before the system can be silenced.

8.2 Automatic Signal Silence (Bell Time-out)

Ref: Section[014] Option [8] Fire Bell Follows Time-out

Ref: Section[005] Bell Time-out (default 004 minutes)

The fire alarm notification appliances may be set to silence automatically after a programmed time. The system is default programmed to silence the notification appliances four minutes after the last initiated fire alarm. If the Fire Time-out option is disabled, the notification appliance can only be silenced manually.

The Bell Time-out timer begins upon the first fire alarm. Each subsequent alarm will restart the timer.

8.3 Manual Sensor Reset ([*][7][2])

The Sensor Reset function is designed so that the user can manually reset latching smoke detectors by entering [*][7][2]. In order for this feature to function, the detectors to be reset must be connected to a programmable output (PGM1-4, AUX+).

Program the output as 'Sensor Reset 2' (PGM output option #03). The output pulse time is by default set at five seconds. For instructions on output programming, see your PC5020CF *Installation Manual*, Section 5.3 'Basic Programming', [009]-[011] Programmable Output Options.

RECOMMENDED: *As a security measure, ensure that a code is required to activate [*][7][2]. This will require that a user enter a valid access code after entering [*][7][2] in order to reset smoke detectors.*

8.4 Subsequent Alarm Operation

If the alarm notification appliances have been silenced – manually or automatically – and a subsequent fire alarm is initiated, the following will occur:

- Audible and visual notification appliances will activate as programmed.
- The Bell Time-out, if used, will restart for a full timing period before automatic silencing.
- The new alarm and all previous alarms/troubles will be displayed.

If a subsequent Fire alarm is initiated before the alarm notification appliances have been silenced, either manually or automatically, then the following will occur:

- The Bell Time-out, if used, will restart for a full timing period before automatic silencing.
- The new alarm will be shown.

8.5 Auto-Scroll LCD Keypad Display

When an alarm is initiated, the Alarm and selected Trouble conditions will be displayed on the system LCD keypad(s). If there is more than one Alarm or Trouble present simultaneously, the keypad will continuously scroll through each event. Items on the scroll list are displayed at two-second intervals. The keypad will beep as each message is displayed.

Although critical Troubles are displayed, Auto-scroll is only initiated upon a Fire Alarm. If a Fire Trouble is detected and a Fire Alarm is not present, the Trouble will be indicated as any other system trouble; the keypad Trouble light will turn on and the keypad buzzer will beep.

The following events are included in the Auto-scroll.

- **'Fire Alarm [Zone Label]'**: This message will appear for all Fire Alarms. Messages are displayed sequentially by zone number.
- **'Fire Trouble [Zone Label]'**: This message will appear for Fire off-normal conditions only and the keypad buzzer will beep once as it is displayed. Messages are displayed sequentially by zone number.
- **'Bell CCT Trouble'**: This message will appear if an open fault is detected on the PC5020CF bell zone.
- **'Failure to Communicate'**: This message will appear when the panel cannot report to the central station.

Auto-scroll will stop when a valid user code is entered to silence the alarm notification appliances.

8.6 Fire Trouble Conditions

In all cases, when the panel detects a Trouble condition, the keypad Trouble light turns on and the keypad buzzer will sound two short beeps every 10 seconds. Pressing any key will silence the audible Trouble signal. The Trouble buzzer will resound if another Trouble is generated.

Fire Zone Trouble

A fire zone Trouble will be generated when an open circuit is detected on any fire zone.

AC Trouble

An AC Fail Trouble is generated if the AC fails on the PC5020CF. AC Troubles are grouped for common indication on a remote annunciator as an 'AC Trouble'.

See also Section 5.6 'Communicator Programming', [377] Communication Variables.

Battery Trouble

A battery Trouble is generated if the PC5020CF/PS5350 panel batteries are open or shorted. This Trouble condition only turns on the keypad Trouble light and sounds the keypad buzzer.

Ground Fault

Ground fault detection must be enabled for Commercial Fire Monitoring installations by connecting the EGND terminal on the PC5020CF to a solid earth ground. Upon detection of a resistance of <40kΩ between any extended conductor and earth ground, a Ground Fault Trouble will be generated via zone 7 of the PC5700 (see *Installation Instructions* for PC5700 fire module v2.0).

TLM Troubles

If the PC5700 module detects a TLM Trouble on telephone line 1 or 2, Zone 8 on the PC5700 will be violated automatically. The panel can only monitor both telephone lines if a PC5700 is connected.

NOTE: *TLM Trouble monitoring should not be disabled.*

Fail To Communicate (FTC)

If the control panel is unable to report to the central station, an FTC Trouble will be generated and the message 'Failure to Communicate' will be added to the Troubles list to advise the user that the central station may not have received the communication about the current alarm status.

8.7 AC Delays

AC Fail TX Delay

AC Fail TX Delay -UL Requirement

If the **AC Fail TX Delay** is programmed, the panel will delay reporting the AC Trouble to the central station for the programmed time.

NOTE: *For 24-hr battery backup (14Ah battery) program AC Fail Transmission Delay for 6 hours. For 60 hour battery backup (60ah battery) program AC Fail Transmission Delay for 15 hours.*

See section 5.6 'Communicator Programming', [377] Communication Variables.

8.8 Fire Reporting Codes

The following reporting codes should be programmed on every PC5020CF system:

Fire Events

2-wire Alarm – This reporting code will be sent when a 2-wire smoke zone alarm occurs. The 2-wire smoke zone acts as a standard fire zone. The 2-wire Alarm Restoral reporting code will be sent when the alarm condition is restored.

Waterflow Alarm – This reporting code will be sent when a waterflow zone alarm occurs. The Waterflow Restoral reporting code will be sent when the alarm condition is restored.

2-wire Trouble – This reporting code will be sent when the 2-wire smoke detector zone has a trouble (open) condition. The 2-wire Trouble Restoral reporting code will be sent when the condition has restored.

Waterflow Trouble – This reporting code will be sent when the waterflow detector zone has a Trouble condition. The waterflow Trouble Restoral reporting code will be sent when the condition has restored.

[F] Key

The panel will transmit a Keypad Fire Alarm reporting code *and* the Keypad Fire Restoral reporting code when the Fire Keys on any keypad are pressed for two seconds.

NOTE: *For commercial applications, do not program the [F] key for keypads that are readily accessible by the public. For more information regarding this key, see the PC5020CF Installation Manual Section 5.3, 'Basic Programming', [015] Third System Option Codes, Option [1].*

System Maintenance

Panel Battery Trouble – This code will be sent when the control panel battery is low, disconnected or if the battery fuse fails. The Battery Trouble Restoral reporting code will be sent when the condition is cleared.

Panel AC Trouble – This code will be sent when the AC power to the control panel is disconnected or interrupted. To prevent communicating the trouble in the event of short power failures, the code will not be sent until the AC Failure Communication Delay has expired. When the Trouble is restored, the AC Line Trouble Restoral reporting code will be sent.

Panel Bell Trouble – This code will be sent when a bell Trouble occurs. This is when an open circuit is detected across the bell terminals. When the Trouble condition is restored, the Main Bell Trouble Restoral reporting code will be transmitted.

Panel AUX Trouble – This code will be sent when an auxiliary voltage supply Trouble occurs. When the voltage supply is restored, the Main Auxiliary Trouble Restoral code will be sent.

GND Fault Trouble – This reporting code will be sent when the earth ground connection detects a ground fault. The Ground Fault Restoral reporting code will be sent when the earth ground fault connection is restored.

NOTE: *The PC5020CF EGND terminal must not be connected to the key ground. Connecting earth ground to the key ground will interfere with system performance and generate a Ground Fault Trouble.*

Periodic Test – This is the reporting code that is sent to the monitoring station to test communications (see PC5020CF *Installation Manual*, section 5.6, 'Communicator Programming', [377] Communication Variables).

Periodic Test TBL – This test transmission code is sent instead of a Periodic Test Transmission if any of the following conditions occur:

- Common Fire Trouble
- Fire Zone Alarm (all zones)
- Fire Alarm (5700)
- Fire Zone Trouble (all zones)
- Fire Zone(s) Bypassed
- AUX Trouble (main panel)
- Key Low Power
- Module Supervisory Fault
- [F] Key Alarm

Section 9: Listing Requirements

9.1 UL Listed Commercial and Residential Installations

The installation requirements listed below must be met for the following grades of service.

Grade AA Central Station and Police Connect

The installation must use T-Link module which communicates over LAN/WAN to the Sur-Gard MLR-IP receiver. Polling time must be 90 seconds. Compromise detection time must be 6 minutes.

Grade A Local

The installation must have a bell which is UL Listed for mecatile local alarms (AMSECO MBL10B with model AB-12 bell housing). The digital communicator must be enabled. The control panel must be in the attack-resistant enclosure (DSC Model CMC-1 or PC4050CAR).

Grade B Central Station and Police Connect

The installation must have a bell which is UL Listed for mecatile local alarms (AMSECO MBL10B with model AB-12 bell housing). The digital communicator must be enabled. The control panel must be in the attack resistant enclosure (DSC Model CMC-1 or PC4050CAR).

Grade C Central Station

The digital communicator must be enabled. The control panel must be in the attack resistant enclosure (DSC Model CMC-1 or PC4050CAR).

All Commercial Installations

- The Entry Delay must not exceed 120 seconds
- The Exit Delay must not exceed 120 seconds.
- The minimum Bell Time-out is 15 minutes.

Residential Installations

- The Entry Delay must not exceed 45 seconds
- The Exit Delay must not exceed 60 seconds.
- The minimum Bell Time-out is 4 minutes.

Home Health Care Signaling Equipment

- There must be at least two keypads, one of either the LCD5500Z or LCD5501Z and one of the following models, PC5508Z, PC5516Z or PC5532Z.
- Each system shall be programmed to activate an audible Trouble signal within 90 seconds upon loss of microprocessor memory.

Programming

The notes in the programming sections describing the system configurations for UL Listed installations must be implemented.

Control of the Protected Premises

In order to have a UL Certificated system the protected area is to be under the responsibility of one ownership and management (i.e., one business under one name). This may be a group of buildings attached or unattached with different addresses but under the responsibility of someone having mutual interest. The person of mutual interest is not the alarm-installing company.

Bell Location

The alarm sounding device (bell) must be located where it can be heard by the person or persons responsible for maintaining the security system during the daily arming cycle.

Protection of the Control Unit

The local control and the local power supply must be protected in one of the following ways:

- The control unit and audible alarm device must be in a protected area which is armed 24 hours a day.
- Each partition must arm the area protecting the control unit and the audible alarm device power supply. This may require duplicate protection armed by each partition. Access to this protected area, without causing an alarm, will require that all partitions be disarmed.
- In all cases described above, the protected area for the control unit must be programmed as not-bypassable.

Casual Users

The installer should caution the user(s) not to give system information to casual users (e.g. codes, bypass methods, etc. to baby-sitters or service people). Only the One-Time Use codes should be given to casual users.

User Information

The installer should advise the users and note in the User's Guide:

- Service organization name and telephone number
- The programmed exit time
- The programmed entry time
- Test system weekly

9.2 Commercial Fire Monitoring Installations

System Specifications

- Class B / Style B 2-Wire Smoke Detector Supervision
- Class B/ Style B Waterflow Supervision
- Service Type: Automatic, Manual, Sprinkler Supervisory, Waterflow
- Signaling Type: Non-coded
- Ground Fault Supervision
- Supervised Dual Telephone Lines

PC5020 CF modules other than those specified have not been investigated by UL for use with commercial fire monitoring alarm systems and cannot be used for commercial fire monitoring service.

All other modules providing burglary service must be provided in a separate enclosure.

Two-Wire Smoke Detector Compatibility

- Maximum loop resistance: 100 Ohms (if available)
- Operating Voltage Range: 8.9 - 12.0 (if available)
- Maximum Alarm Current: 87.5 mA (if available)
- Compatibility Identifier: PC5-2

Please see the Compatibility Listing Chart, section 1.2 'Hardware Description and Specifications' for a list of compatible 2-wire smoke detectors.

Hardware Requirements

A UL Listed fire monitoring installation must include at least the following:

- PC5020CF & PC4050 CR control unit
- PC5700 fire module or T-Link module
- Batteries of sufficient capacity or PS5350 with batteries to provide 24 hours of standby supervision followed by five minutes of alarm notification for central monitoring station use.
- PS5350 with batteries to provide 60 hours of standby supervision followed by 5 minutes of alarm notification for remote station supervision.
- At least one keypad (the LCD5500Z is recommended), which must be located near the control panel.
- Notice on page 60 must be permanently located close to this keypad.
- UL Listed input and output devices as required (not supplied)
- The PC5020 must be configured to communicate solely to a SG-MLR2-DG receiver or when using the T-Link Communicator it must communicate solely to a Sur-Gard MLR-IP receiver for central and remote station services

Programming Requirements

Ensure that the hardware has been installed and connected correctly before attempting to program. For Commercial Fire programming guidelines, refer to Appendix C of the *Programming Worksheets*.

9.3 ULC Listing Requirements

For ULC installations please refer to the ULC Wiring Diagram part #18006238 and the ULC Installation Information Sheet part #29002157.

Appendix A: Reporting Codes

The following tables contain Contact ID and Automatic SIA format reporting codes. For more information on reporting code formats and notes about individual reporting codes, (see section 5.6 'Communicator Programming' PWS Sect 6).

Contact ID

The first digit (in parentheses) will automatically be sent by the control panel. The second two digits are programmed to indicate specific information about the signal. For example, if zone 1 is an entry/exit point, you could program the event code as [34]. The central station would receive the following:

*BURG - ENTRY/EXIT - 1 where the '1' indicates which zone went into alarm.

SIA Format - Level 2 (Hardcoded)

The SIA communication format used in this product follows the level 2 specifications of the SIA Digital Communication Standard - October 1997. This format will send the account code along with its data transmission. The transmission will look similar to the following at the receiver:

N Ri01 BA 01
 N = New Event
 Ri01 = Partition / Area Identifier
 BA = Burglary Alarm
 01 = Zone 1

NOTE: A system event will use the Area Identifier Ri00.

Section #	Reporting Code	Code Sent When...	Dialer Direction*	Automatic Contact ID Codes	SIA Auto Rep Codes**
[320]-[323]	Zone Alarms	Zone goes into alarm	A/R	See Table 3	See Table 3
[324]-[327]	Zone Restorals	Alarm condition has been restored	A/R		
[328]	Duress Alarm	Duress code entered at keypad	A/R	(1) 21	HA-00
[328]	Opening After Alarm	System disarmed with alarm in memory	A/R	(4) A6	OR-00
[328]	Recent Closing	Alarm occurs within two minutes of system arming	A/R	(4) 59	CR-00
[328]	Zone Expander Supervisory Alarm/Rest.	Panel loses/restores supervisory transmission over the Keybus from zone expansion modules, or keypads with zone inputs	A/R	(1) 43	UA-00/UH-00
[328]	Cross Zone (Police Code) Alarm	Two zones on the same partition go into alarm during any given armed-to-armed period (incl. 24-hr zones)	A/R	(1) 39	BM-00/BV-00
[328]	Burglary Not Verified	This reporting code will be sent after the Burglary Verified Timer expires after a zone alarm occurs.	A/R	(3) 78	BG-00
[328]	Alarm Cancelled	This reporting code will be sent if a valid access code is entered during the Alarm Cancel window	A/R	(4) A6	BC-00
[329]	[F] Key Alarm/Restoral	Keypad fire alarm (alarm and restoral reporting codes sent together)	A/R	(1) 15	FA-00/FH-00
[329]	[A] Key Alarm/Restoral	Keypad auxiliary alarm (alarm and restoral reporting codes sent together)	A/R	(1) AA	MA-00/MH-00
[329]	[P] Key Alarm/Restoral	Keypad panic alarm (alarm and restoral reporting codes sent together)	A/R	(1) 2A	PA-00/PH-00
[329]	Aux Input Alarm/Restoral	Option#23/24: a panic button wired to PGM 2 is pressed/ access code is entered Option #04: a 2-wire smoke detector wired to PGM 2 goes into alarm/alarm is cleared.	A/R	(1) 4A	UA-99/UH-99
			A/R	(1) 11	FA-99/FH-99
[330]-[337]	Zone Tamper/Restoral	Zone is tampered / Tamper condition restored	T/R	(1) 44	TA-ZZ/TR-ZZ
[338]	General System Tamper/Rest.	Enrolled module with tamper inputs has a Tamper alarm/all module Tampers restored	T/R	(1) 45	TA-00/TR-00
[338]	Keypad Lockout	Maximum number of incorrect access codes has been entered at a keypad	T/R	(4) 21	JA-00
[339-341]	Closings	System armed (user 01-34, 40-42 indicated)	O/C	(4) A2	CL-UU
[341]	Partial Closing	One or more zones bypassed when system armed	O/C	(4) 7A	CG-ZZ
[341]	Special Closing	Closing (arming) using one of the following methods: quick arm, auto-arm, keyswitch, function key, maintenance code, DLS software, wireless key	O/C	(4) AA	CL-00
[341]	Late to Close	Whenever the auto-arm pre-alert sounds (if the Late to Close option is enabled)	O/C	(4) A4	CI-00
[341]	Exit Fault	When Exit Fault Pre-Alert occurs and Entry Delay expires before the system is disarmed	O/C	(4) 57	EE-00
[342-344]	Openings	System disarmed (user 01-34, 40-42 indicated)	O/C	(4) A2	OP-UU
[344]	Auto-arm Cancellation	Auto-arm cancelled	O/C	(4) A5	CE-00

* A/R = alarms/restorals; T/R = tampers/restorals; O/C = openings/closings; MA/R = miscellaneous alarms/restorals; T = test transmissions

** UU = user number (user01-42); ZZ = zone number (01-64)

Section #	Reporting Code	Code Sent When...	Dialer Direction*	Automatic Contact ID Codes	SIA Auto Reporting Codes**
[344]	Special Opening	Opening (disarming) using one of the following methods: key-switch, maintenance code, DLS software, wireless key	O/C	(4) AA	OP-00
[345]-[346]	Battery Trouble/Restoral	PC5020 battery is low/battery restored	MA/R	(3) A2	YT-00/YR-00
[345]-[346]	AC Line Trouble/Restoral	AC power to control panel is disconnected or interrupted/AC power restored (Both codes follow AC Failure Comm. Delay.)	MA/R	(3) A1	AT-00/AR-00
[345]-[346]	Bell Circuit Trouble/Restoral	Open or short circuit detected across bell terminals/bell circuit restored	MA/R	(3) 21	YA-99/YH-99
[345]-[346]	Fire Trouble/Restoral	Trouble occurs/restores on a fire zone	MA/R	(3) 73	FF-00/FJ-00
[345]-[346]	Auxiliary Power Trouble/Rest.	Aux voltage supply trouble/restoral	MA/R	(3) AA	YP-00/YQ-00
[345]	TLM Failure	Telephone line monitoring trouble (sent via LINKS1000. Do not program if LINKS1000 not used)	MA/R	(3) 51	LT-00
[346]	TLM Restore	Telephone line restored	MA/R	(3) 51	LR-00
[345]-[346]	Gen System Trouble/Restoral	'Service Required' Trouble occurs (view troubles using [*][2])/trouble restored	MA/R	(3) AA	YX-00/YZ-00
[345]-[346]	Gen System Supervisory Trouble/Restoral	Control panel loses/restores communications with module(s) connected to the Keybus	MA/R	(3) 33	ET-00/ER-00
[347]	Phone# 1 or 2 FTC Restoral	Control panel has restored communications to central station on Phone# 1 or 2 (after FTC)	MA/R	(3) 54	YK-00
[347]	Event Buffer is 75% Full	Event buffer is almost full since last upload	MA/R	(6) 23	JL-00
[347]	DLS Lead In	Downloading session start	MA/R	(4) 11	RB-00
[347]	DLS Lead Out	Downloading session complete	MA/R	(4) 12	RS-00
[347]	Zone Fault/Rest.	One or more zones have faults/restored	MA/R	(3) 72	UT-ZZ/UJ-ZZ
[347]	Delinquency	Programmed amount of time (days or hours) for delinquency has expired without zone activity, or without system being armed	MA/R	(4) 54***	CD-00
[347]	Wireless Device Low Battery Trouble/Rest.	Wireless zones, panic pendants, handheld keypads, wireless keys have low battery/all low batteries restored	MA/R	(3) 84	XT-00/XR-00 XT-ZZ/XR-ZZ****
[347]	Installer Lead In	Installer Programming has been entered	MA/R	(6)27	LB-00
[347]	Installer Lead Out	Installer Programming has been exited	MA/R	(6)28	LS-00
[348]	Walk Test End	End of test	T	(6) A7	TS-00
[348]	Walk Test Begin	Beginning of test	T	(6) A7	TE-00
[348]	Periodic Test with Trouble	Periodic system test transmission with trouble	T	(6) A8	RP-01
[348]	Periodic Test	Periodic system test transmission	T	(6) A2	RP-00
[348]	System Test	[*][6] bell/communications test	T	(6) A1	RX-00
[348]	LINKS1000 Test	LINKS1000 test transmission	T	(6) A3	TX-00
[349]	PC5700 Ground Fault Trouble/Restoral	Ground/Fault/Trouble occurs on the PC5700	MA/R	(3) 1A	US-00
[349]	PC5700 TLM Line 1 Trouble/Restoral	TLM Trouble /Restoral occurs on the PC5700	MA/R	(3) 51	LT-XX
[349]	PC5700 TLM Line 2 Trouble/Restoral	TLM Trouble /Restoral occurs on the PC5700	MA/R	(3) 52	LR-XX

* A/R = alarms/restorals; T/R = tampers/restorals; O/C = openings/closings; MA/R = miscellaneous alarms/restorals; T = test transmissions
** UU = user number (user01-42); ZZ = zone number (01-64)
*** Use the Fail to Close event code [(4)54] to report closing or activity delinquency. Ensure the central station is aware that this code is used.
**** Zones are identified; panic pendants, wireless keys, and handheld keypads are not.

Table2: Contact ID Zone Alarm/Restoral Event Codes (as per ADEMCO):

Program any of these codes for zone alarms/restorals when using the standard (non-automatic) Contact ID reporting format.

Medical Alarms	(1)34 Entry / Exit
(1)AA Medical	(1)35 Day / Night
(1)A1 Pendant Transmitter	(1)36 Outdoor
(1)A2 Fail to Report In	(1)37 Tamper
Fire Alarms	(1)38 Near Alarm
(1)1A Fire Alarm	General Alarms
(1)11 Smoke	(1)4A General Alarm
(1)12 Combustion	(1)43 Exp. module failure
(1)13 Waterflow	(1)44 Sensor tamper
(1)14 Heat	(1)45 Module Tamper
(1)15 Pull Station	(1)4A Cross Zone Police Code
(1)16 Duct	24-hr Non-Burglary
(1)17 Flame	(1)5A 24-hr non-Burg
(1)18 Near Alarm	(1)51 Gas detected
Panic Alarms	(1)52 Refrigeration
(1)2A Panic	(1)53 Loss of Heat
(1)21 Duress	(1)54 Water Leakage
(1)22 Silent	(1)55 Foil Break
(1)23 Audible	(1)56 Day Trouble
Burglar Alarms	(1)57 Low bottled Gas level
(1)3A Burglary	(1)58 High Temp
(1)31 Perimeter	(1)59 Low Temp
(1)32 Interior	(1)61 Loss of Air Flow
(1)33 24-hr	

Table 3: SIA Format Automatic Zone Alarm/Restoral Codes

Zone Definition	SIA Auto Rep Codes*	Contact ID Auto Rep Codes*
	Zone Alm/Rest.	Zone Alm/Rest.
Delay 1	BA-ZZ/BH-ZZ	(1) 3A
Delay 2	BA-ZZ/BH-ZZ	(1) 3A
Instant	BA-ZZ/BH-ZZ	(1) 3A
Interior	BA-ZZ/BH-ZZ	(1) 3A
Interior Stay/Away	BA-ZZ/BH-ZZ	(1) 3A
Delay Stay/Away	BA-ZZ/BH-ZZ	(1) 3A
Delayed 24-hr Fire	FA-ZZ/FH-ZZ	(1) 1A
Standard 24-hr Fire	FA-ZZ/FH-ZZ	(1) 1A
24-hr Supervisory	US-ZZ/UR-ZZ	(3) 8A
24-hr Supervisory Buzzer	UA-ZZ/UH-ZZ	(1) 3A
24-hr Burg	BA-ZZ/BH-ZZ	(1) 3A
24-hr Holdup	HA-ZZ/HH-ZZ	(1) 22
24-hr Gas	GA-ZZ/GH-ZZ	(1) 5A
24-hr Heat	KA-ZZ/KH-ZZ	(1) 5A
24-hr Medical	MA-ZZ/MH-ZZ	(1) AA
24-hr Panic	PA-ZZ/PH-ZZ	(1) 2A
24-hr Emergency (non-medical)	QA-ZZ/QH-ZZ	(1) A1
24-hr Sprinkler	SA-ZZ/SH-ZZ	(1) 13
24-hr Waterflow	WA-ZZ/WH-ZZ	(1) 5A
24-hr Freeze	ZA-ZZ/ZH-ZZ	(1) 5A
24-hr Latching	BA-ZZ/BH-ZZ	(1) 3A
Interior Delay	BA-ZZ/BH-ZZ	(1) 3A
Delayed 24-hr Waterflow	SA-ZZ/SH-ZZ	(1) 13
Instant 24-hr Waterflow	SA-ZZ/SH-ZZ	(1) 13
Auto Verified Fire	FA-ZZ/FH-ZZ	(1) 1A
24-hr Fire Supervisory	FS-ZZ/FR-ZZ	(2) AA
Day Zone	BA-ZZ/BH-ZZ	(1) 3A
Delayed 24-hr Fire (Wireless)	FA-ZZ/FH-ZZ	(1) 1A
Standard 24-hr Fire (Wireless)	FA-ZZ/FH-ZZ	(1) 1A

* ZZ = zones 01-64

Appendix B: Wiring Diagrams

B.1 PC5020CF Wiring Diagram (Ground Connection, Zone Circuits)

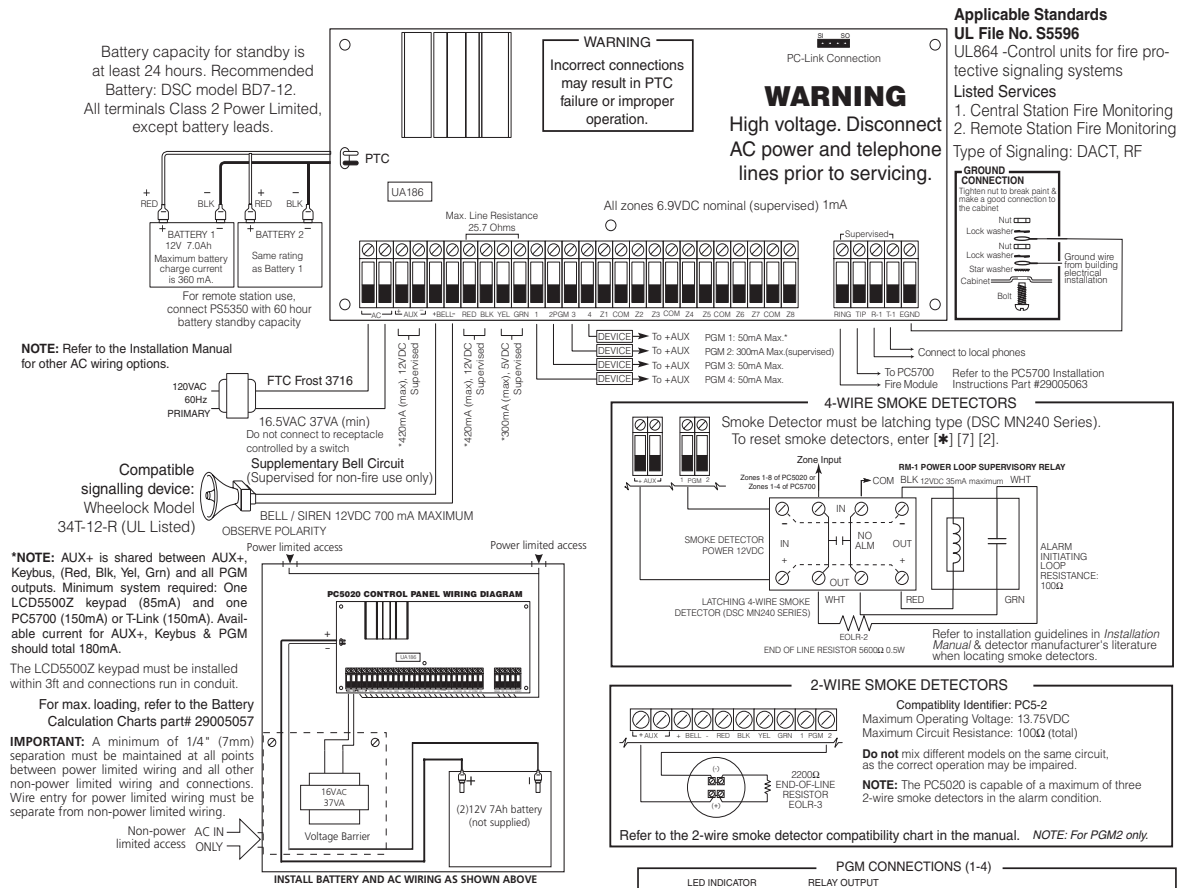

NOTE: Refer to the Installation Manual for other AC wiring options.

NOTE: AUX+ is shared between AUX+, Keybus, (Red, Blk, Yel, Grn) and all PGM outputs. Minimum system required: One LCD5500Z keypad (85mA) and one PC5700 (150mA) or T-Link (150mA). Available current for AUX+, Keybus & PGM should total 180mA. The LCD5500Z keypad must be installed within 3ft and connections run in conduit.

IMPORTANT: A minimum of 1/4" (7mm) separation must be maintained at all points between power limited wiring and all other non-power limited wiring and connections. Wire entry for power limited wiring must be separate from non-power limited wiring.

WARNING - Not to be removed by anyone except occupant. This equipment should be installed in accordance with the National Fire Code ANSI/NFPA 72 (National Fire Protection Association, Batterymarch Park, Quincy MA, 02269). Printed information describing proper installation, operation, testing, maintenance, evacuation planning, and repair service is to be provided with this equipment. This unit includes an alarm verification feature that will result in a delay of the system alarm signal from the indicated circuits. The total delay (control unit plus smoke detectors) shall not exceed 60 seconds. No other smoke detector shall be connected to these circuits unless approved by the local authority having jurisdiction. For compliance with UL-985, at least one hardwired smoke detector is required.

RESISTOR IDENTIFICATIONS

Compatible 2-wire Smoke Detectors

Name	Model	Compatibility ID	Max #	Base
DSC	MN220 /R/-T/RT	PS-220	30	None
System Sensor	2100AT	A	30	None
	2100TR	A	30	None
Sentrol	429AT or 521B/BXT SW1 on	S09A	30	None
	400 series, 429C, 429CT	S10A	30	None
	499CRT, 429CSST, 429CS7	S11A	30	None
	521CRKT	S11A	30	None
	521B, 521BXT, SW1 off	S10A	30	None
	7111UUT, 712U, 7111UUT, 712U	S10A	30	None
	713-9U, 713-6U, 722U	S10A	30	None
	731U, 731UD, 732U	S11A	30	None

Refer to the PC5020/PC5020CF Installation Manual P/N 29005907, Instruction Manual P/N 29005909. The PC5020 is UL Listed for limited energy installations per NEC Article 760. Recognized limited energy cable should be used. Observe NEC wiring requirements and local codes defined by the authority having jurisdiction. Printed information describing proper installation, operation, testing, maintenance, evacuation planning, and repair service is to be provided with this equipment. Security detection devices that require power from the control panel must be UL Listed for the intended application and operate over the range of 10.0 to 14.0 VDC. The DSC Bravo Series is a recommended UL Listed motion detector.

Temperature Range: 0°C to 49°C (32°F to 120°F)

Maximum Humidity: 85% relative humidity

Control panel is suitable for the following UL installations:

- Grade AA Central Station and Grade AA Police Connect with high line security (using T-Link to communicate to Sur-Gard MLR-IP receiver)
- Household Fire and Grade A Household Burglary & Home Health Care Signaling Equipment
- Grade A Local
- Grade B Central Station and Grade A Police Connect with basic line security
- Grade C Central Station and Grade A Police Connect with basic line security

TABLE 1

Circuit (zone)	Control Unit Delay - Sec.	Smoke Detector	
		Model	Delay - Sec. (a)

(a) The delay (power-up) (start-up) time marked on the installation wiring diagram of the smoke detector or on the installed smoke detector(s) is to be used.

NOTE: For ULC installations, please refer to the ULC Wiring Diagram part#18006238 and the ULC Installation Information Sheet part#29002157.

B.2 PC5020CF and PC5700 Fire Module Communications Connections

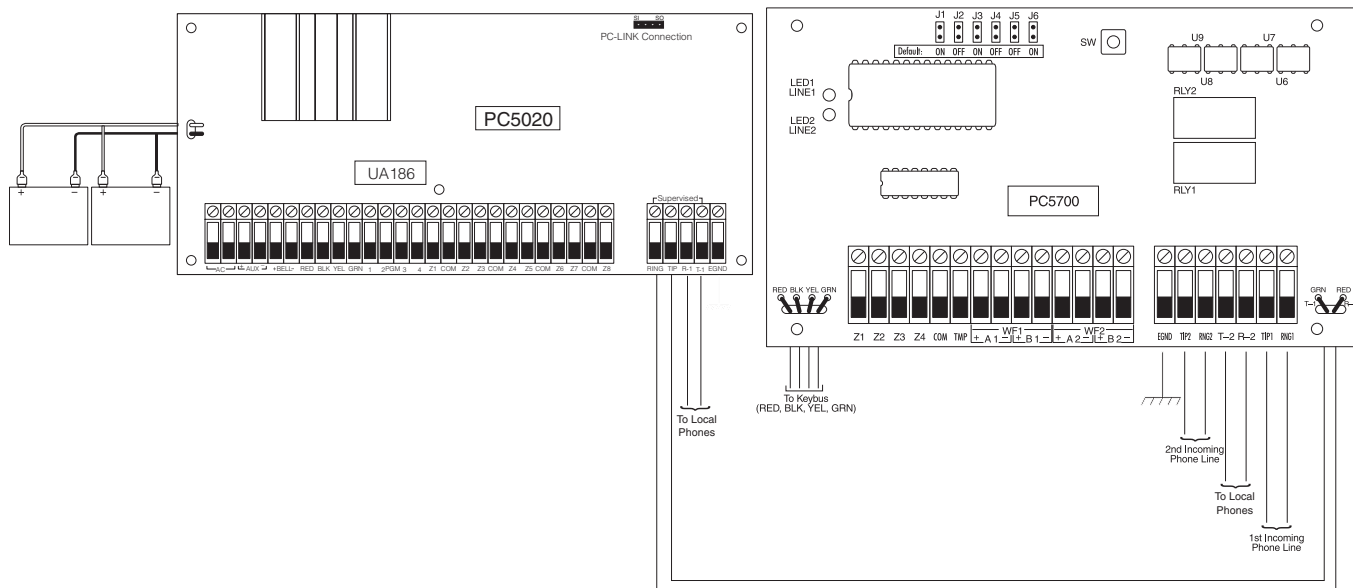

B.3 Battery Lead and AC Power Lead Routing for Central Station Fire Monitoring Systems

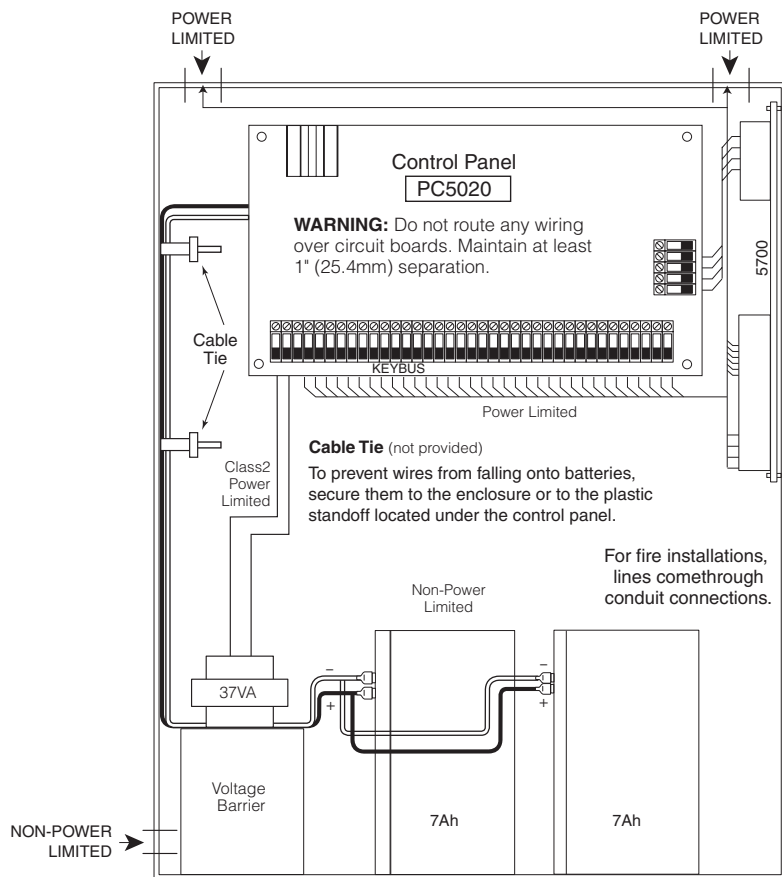

INSTALL BATTERY AND AC WIRING AS SHOWN ABOVE
IMPORTANT: A minimum 1/4" (6.4mm) separation must be maintained at all points between battery/primary AC wiring and all other wiring connections.

B.4 Battery Lead and AC Power Routing for UL Listed Remote Fire Monitoring Systems with the PS5350 AC Output Connection

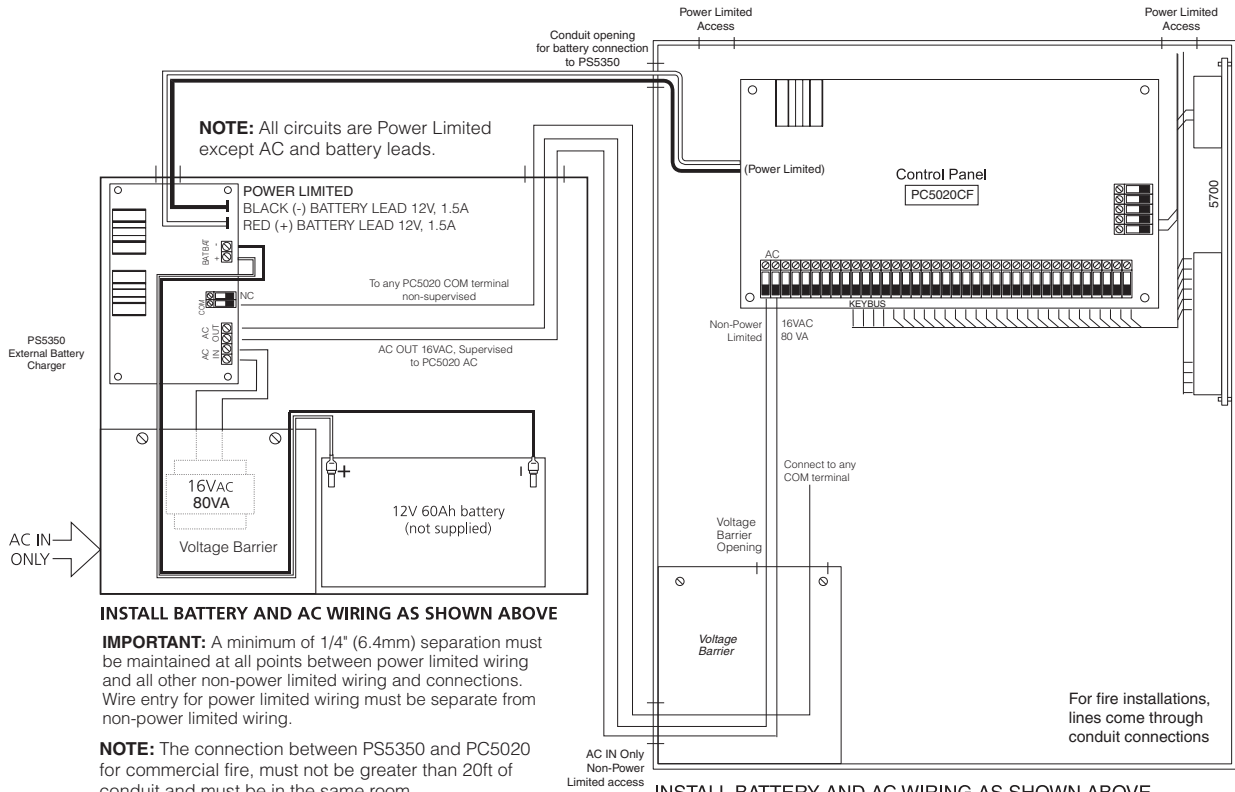

INSTALL BATTERY AND AC WIRING AS SHOWN ABOVE

IMPORTANT: A minimum of 1/4" (6.4mm) separation must be maintained at all points between power limited wiring and all other non-power limited wiring and connections. Wire entry for power limited wiring must be separate from non-power limited wiring.

NOTE: The connection between PS5350 and PC5020 for commercial fire, must not be greater than 20ft of conduit and must be in the same room.

INSTALL BATTERY AND AC WIRING AS SHOWN ABOVE

IMPORTANT: A minimum of 1/4" (6.4mm) separation must be maintained at all points between battery/primary AC wiring and all other wiring and connections.

B.5 Sensor Reset for 2-Wire Smoke Detectors

AUX Connection

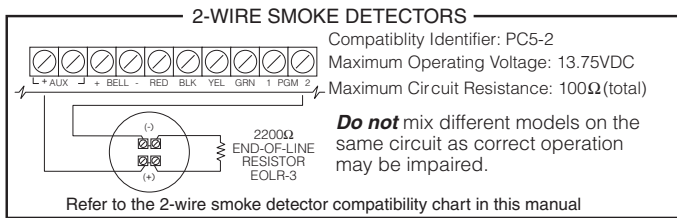

NOTE: Do not combine the 2-wire smoke detector and 4-wire smoke detector on PGM2 (only 2-wire smoke detectors on PGM2). Please see section 2.6 section 7.6 'Four-Wire Smoke Detector Zones'

B.6 Sensor Reset for 4-wire Smoke Detectors

AUX Connection

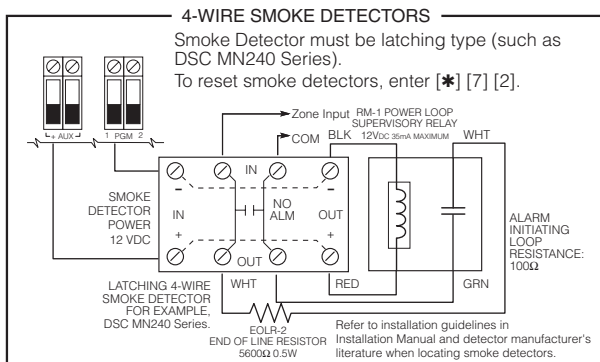

B.7 Other PGM Connections

LED INDICATOR

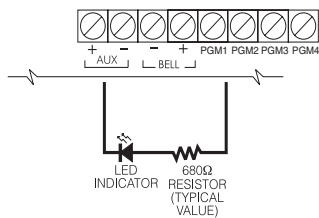

RELAY OUTPUT

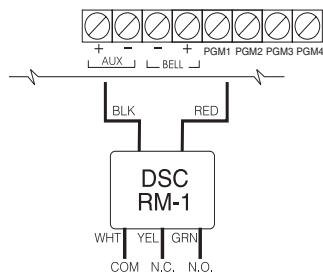

NOTE: For devices requiring more than 50mA, use a relay (DSC RM-1) or UL-recognized parts only for this application.

NOTE: The RM-1 relay module cannot be installed outside of the main panel enclosure.

This notice is to be framed and mounted adjacent to the control unit or the keypad at the main entrance.

Fire Alarm Monitoring Operating Instructions

Normal Standby

No audible or visual indicators.

Fire Alarm

Pulsing audible alarm; the following message will be displayed on the keypad:

Alarm [Zone Label]

This message will be accompanied by other messages related to the alarm. The keypad will scroll through each message at 2-second intervals.

To silence an alarm, enter an access code

The alarm messages will be displayed until the initiating devices are mechanically reset.

To Reset Smoke Detectors

Enter an access code to reset smoke detectors.

Alarm Test

Activate smoke detector or waterflow sensor according to manufacturer's testing instructions.

Bell and Communicator Test

Enter [*][6][Access Code][4] on a system keypad.

Trouble Conditions

Trouble conditions are indicated by:

- The keypad Trouble light will turn ON
- The keypad buzzer will beep

To view Trouble conditions:

- Press [*][2]. The keypad display will indicate the Trouble.

To silence the Trouble beeps:

- Enter a valid access code at any keypad. The Trouble light remains on and you can view Trouble messages using [*][2] until the Trouble has been cleared and the affected detectors are reset.

NOTE: *In the event of Trouble with the Fire Detection section of this system, contact:*

Name:

Address:

Telephone:

FCC COMPLIANCE STATEMENT

CAUTION: Changes or modifications not expressly approved by Digital Security Controls Ltd. could void your authority to use this equipment.

This equipment has been tested and found to comply with the limits for a Class B digital device, pursuant to Part 15 of the FCC Rules. These limits are designed to provide reasonable protection against harmful interference in a residential installation. This equipment generates, uses and can radiate radio frequency energy and, if not installed and used in accordance with the instructions, may cause harmful interference to radio communications. However, there is no guarantee that interference will not occur in a particular installation. If this equipment does cause harmful interference to radio or television reception, which can be determined by turning the equipment off and on, the user is encouraged to try to correct the interference by one or more of the following measures:

- Re-orient the receiving antenna.
- Increase the separation between the equipment and receiver.
- Connect the equipment into an outlet on a circuit different from that to which the receiver is connected.
- Consult the dealer or an experienced radio/television technician for help.

The user may find the following booklet prepared by the FCC useful: "How to Identify and Resolve Radio/Television Interference Problems". This booklet is available from the U.S. Government Printing Office, Washington D.C. 20402, Stock # 004-000-00345-4.

IMPORTANT INFORMATION

This equipment complies with Part 68 of the FCC Rules. On the side of this equipment is a label that contains, among other information, the FCC registration number and ringer equivalence number (REN) for this equipment. If requested, this number must be provided to the Telephone Company.

FCC Registration Number: F53CAN-34330-AL-E
REN: 0.1B
USOC Jack: RJ-31X

Telephone Connection Requirements

A plug and jack used to connect this equipment to the premises wiring and telephone network must comply with the applicable FCC Part 68 rules and requirements adopted by the ACTA. A compliant telephone cord and modular plug is provided with this product. It is designed to be connected to a compatible modular jack that is also compliant. See installation instructions for details.

Ringer Equivalence Number (REN)

The REN is used to determine the number of devices that may be connected to a telephone line. Excessive RENs on a telephone line may result in the devices not ringing in response to an incoming call. In most but not all areas, the sum of RENs should not exceed five (5.0). To be certain of the number of devices that may be connected to a line, as determined by the total RENs, contact the local Telephone Company. For products approved after July 23, 2001, the REN for this product is part of the product identifier that has the format:

US: AAAEQ##TXXXX. The digits represented by ## are the REN without a decimal point (e.g., 03 is a REN of 0.3). For earlier products, the REN is separately shown on the label.

Incidence of Harm

If this equipment PC5020 causes harm to the telephone network, the telephone company will notify you in advance that temporary discontinuance of service may be required. But if advance notice is not practical, the Telephone Company will notify the customer as soon as possible. Also, you will be advised of your right to file a complaint with the FCC if you believe it is necessary.

Changes in Telephone Company Equipment or Facilities

The Telephone Company may make changes in its facilities, equipment, operations or procedures that could affect the operation of the equipment. If this happens the Telephone Company will provide advance notice in order for you to make necessary modifications to maintain uninterrupted service.

Equipment Maintenance Facility

If trouble is experienced with this equipment PC5020, for repair or warranty information, please contact the facility indicated below. If the equipment is causing harm to the telephone network, the Telephone Company may request that you disconnect the equipment until the problem is solved. This equipment is of a type that is not intended to be repaired by the end user.

Simplex Time Recorder Co. 100 Simplex Drive, Westminster MA 01441-0001 USA,
Tel: (978) 731-2500

Additional Information

Connection to party line service is subject to state tariffs. Contact the state public utility commission, public service commission or corporation commission for information. Alarm dialing equipment must be able to seize the telephone line and place a call in an emergency situation. It must be able to do this even if other equipment (telephone, answering system, computer modem, etc.) already has the telephone line in use. To do so, alarm dialing equipment must be connected to a properly installed RJ-31X jack that is electrically in series with and ahead of all other equipment attached to the same telephone line. Proper installation is depicted in the figure below. If you have any questions concerning these instructions, you should consult your telephone company or a qualified installer about installing the RJ-31X jack and alarm dialing equipment for you.

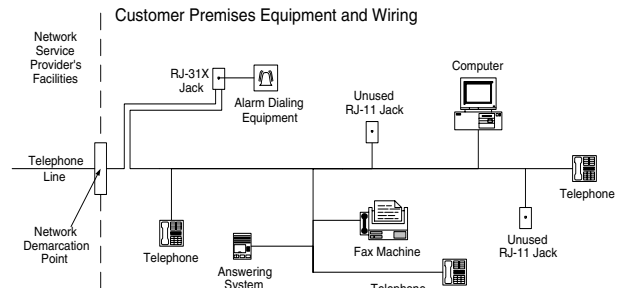

Industry Canada Statement

AVIS: L'étiquette de l'Industrie Canada identifie le matériel homologué. Cette étiquette certifie que le matériel est conforme à certaines normes de protection, d'exploitation et de sécurité des réseaux de télécommunications. Industrie Canada n'assure toutefois pas que le matériel fonctionnera à la satisfaction de l'utilisateur.

Avant d'installer ce matériel, l'utilisateur doit s'assurer qu'il est permis de le raccorder aux installations de l'entreprise locale de télécommunication. Le matériel doit également être installé en suivant une méthode acceptée de raccordement. L'abonné ne doit pas oublier qu'il est possible que la conformité aux conditions énoncées ci-dessus n'empêchent pas la dégradation du service dans certaines situations.

Les réparations de matériel homologué doivent être effectuées par un centre d'entretien canadien autorisé désigné par le fournisseur. La compagnie de télécommunications peut demander à l'utilisateur de débrancher un appareil à la suite de réparations ou de modifications effectuées par l'utilisateur ou à cause de mauvais fonctionnement.

Pour sa propre protection, l'utilisateur doit s'assurer que tous les fils de mise à la terre de la source d'énergie électrique, les lignes téléphoniques et les canalisations d'eau métalliques, s'il y en a, sont raccordés ensemble. Cette précaution est particulièrement importante dans les régions rurales.

AVERTISSEMENT: L'utilisateur ne doit pas tenter de faire ces raccordements lui-même; il doit avoir recours à un service d'inspection des installations électriques, ou à un électricien, selon le cas.

L'indice de charge (IC) assigné à chaque dispositif terminal indique, pour éviter toute surcharge, le pourcentage de la charge totale qui peut être raccordée à un circuit téléphonique bouclé utilisé par ce dispositif. La terminaison du circuit bouclé peut être constituée de n'importe quelle combinaison de dispositifs, pourvu que la somme des indices de charge de l'ensemble des dispositifs ne dépasse pas 100.

L'Indice de charge de ce produit est 0.1B.

NOTICE: The Industry Canada label identifies certified equipment. This certification means that the equipment meets certain telecommunications network protective, operational and safety requirements. Industry Canada does not guarantee the equipment will operate to the user's satisfaction.

Before installing this equipment, users should ensure that it is permissible to be connected to the facilities of the local telecommunications company. The equipment must also be installed using an acceptable method of connection. The customer should be aware that compliance with the above conditions may not prevent degradation of service in some situations.

Repairs to certified equipment should be made by an authorized Canadian maintenance facility designated by the supplier. Any repairs or alterations made by the user to this equipment, or equipment malfunctions, may give the telecommunications company cause to request the user to disconnect the equipment.

User should ensure for their own protection that the electrical ground connections of the power utility, telephone lines and internal metallic water pipe system, if present, are connected together. This precaution may be particularly important in rural areas.

CAUTION: Users should not attempt to make such connections themselves, but should contact the appropriate electric inspection authority, or electrician, as appropriate.

The Load Number (LN) assigned to each terminal device denotes the percentage of the total load to be connected to a telephone loop which is used by the device, to prevent overloading. The termination on a loop may consist of any combination of devices subject only to the requirement that the total of the Load Numbers of all the devices does not exceed 100.

The Load Number of this unit is 0.1B.

PC5020 Module Compatibility

Module	Compatible?	Comments
Classic Escort (VPM-1)	No	
DLM-1	No	
DLM-4 v1.x	No	
DLM-4 v1.0L	Yes	
DLM-7	No	
Escort5580 v3.0	Yes	Fully compatible with Power864.
LCD5500 v1.X	Yes	No Keypad zone support. Some display messages not supported. Can only be used on Partition 1 and Partition 2, and the first 32 zones.
LCD5500Z v2.X	Yes	Can only be used on Partition 1 and Partition 2, and the first 32 zones.
LCD5501Z v1.x	Yes	Can only be used on Partition 1 and Partition 2, and the first 32 zones.
LCD5500Z v3.X	Yes	Fully compatible with Power864.
LCD5501Z v2.x	Yes	Fully compatible with Power864.
LCD5501Z32-433	Yes	Fully compatible with Power864.
LCD600	No	
LED615	No	
Links1000 v3.0	Yes	
Links2150 v1.3W	Yes	Some events not supported (reporting zones 33-64 and partitions 3-8).
Links2450 v1.3	Yes	Some events not supported (reporting zones 33-64 and partitions 3-8).
PC-16 Out	No	
PC5100	Yes	Can only add addressable devices to the first 32 zones.
PC5108 v1.X	Yes	Can only support the first 32 zones. Enrolls as two expander modules - each module will use up two supervisory slots.
PC5108L	Yes	Can only be assigned zones from 9 to 32. Will not support zones 33 to 64. Camera scripts can only be run for zones 9 to 32. Enrolls as two expander modules and uses two supervisory slots.
PC5108 v2.x	Yes	Fully compatible with Power864.
PC5132 v1.X	Yes	No support for Wireless Keys, Pendants or Handheld Keypads. Only the first 32 zones can be used as wireless zones.
PC5132 v2.X	Yes	No identified Wireless Keys support. Only the first 32 zones can be used as wireless zones.
PC5132 v3.X	Yes	Only the first 32 zones can be used as wireless zones.
PC5200	Yes	Fully compatible with Power864.
PC5204	Yes	Fully compatible with Power864.
PC5208	Yes	Fully compatible with Power864.
PC5320	Yes	Fully compatible with Power864.
PC5400 Printer/DVACS Module v1.X to v2.2	Yes	Some printing messages not supported. Some events not supported.
PC5400 Printer/DVACS Module v3.0	Yes	Fully compatible with Power864.
PC55XX	Yes	No Keypad zone support. Can only be used on Partition 1 and Partition 2, and the first 8, 16, or 32 zones.
PC55XXZ	Yes	Can only be used on Partition 1 and Partition 2, and the first 8, 16, or 32 zones.
PC5506	No	
PC5509	No	
PC5700 v1.X	Yes	Enrolls as two expander modules - each module will use up two supervisory slots.
PC5700 v2.0	Yes	Fully compatible with Power864.
PC5720	Yes	Can only support the first 32 zones. Enrolls as two expander modules - each module will use up two supervisory slots. Some events not supported
PC5908	No	
PC5928	No	
PC5936	Yes	Fully compatible with Power864.
Skyroute v2.2	Yes	Some events not supported (reporting zones 33-64 and partitions 3-8).
Skyroute v2.3	Yes	Fully compatible with Power864.
SL-XX	No	
T-Link	Yes	For UL Grade AA / ULC Level 3

