

NEKA

Outdoor Self-Powered Siren



Installation Instructions

CE

tyco

Description

The **NEKA** range provides the following models:

- NEKA**, self-powered horn with flash;
- NEKA-F**, self-powered horn with flash and foam tamper device;
- NEKA-FS**, self-powered horn with strobe and foam tamper device.

This manual provided installation instructions for all **NEKA** sirens. Information relating to a specific model is denoted by the applicable model number within the text. The term "siren" is used to describe functionality that is applicable to all series.

This siren is a self-powered microprocessor controlled horn strobe/flash, especially designed to provide differentiated audible and visual alarm signals.

The distinctive low profile shape is acoustically very efficient and ensures uniform sound distribution.

Robust construction and state-of-the-art technology greatly extend application flexibility, whilst microprocessor supervision of the battery charge (**NEKA** and **NEKA-F** only), horn and flash ensure maximum performance and reliability.

Parts

1	Screws (2) for innerplate fixing.	12	Cable entry.
2	Screws (2) for cover fixing.	13	Strobe board (NEKA-FS only).
3	Battery connector.	14	Flash bulb (NEKA and NEKA-F only).
4	Connector for strobe board or flash bulb.	15	Tamper device.
5	Connector for foam tamper device.	16	Hole for wall-tamper plate fixing.
6	Jumpers for operating mode setup.	17	Loudspeaker.
7	Jumpers for tamper mode setup.	18	Foam tamper device (NEKA-F and NEKA-FS only).
8	Connector for tamper device switch.	19	Battery location.
9	Terminal board.	20	Battery connection cable.
10	Electronic board.	21	Hole for siren temporary hanging.
11	Backplate anchor screw locations (4).		

Table 1 – *Parts*.

Figure 1 – Parts: a) cover; b) innerplate; c) backplate; e) Electronic board.

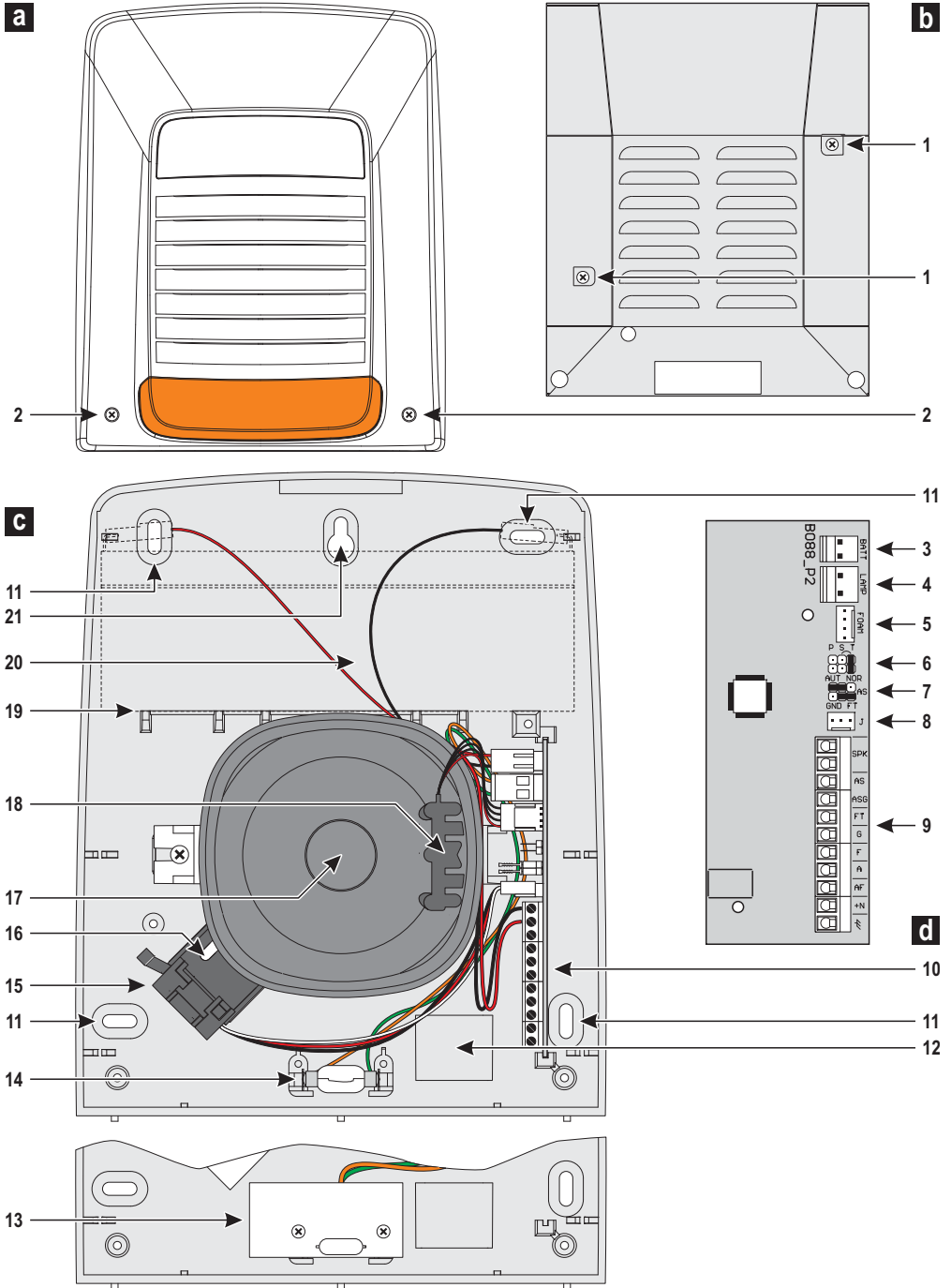

General features

- Self-powered microprocessor controlled horn with strobe/flash for outdoor applications.
- New design.
- Strong weatherproof plastic material moulding.
- Tropicalized-steel innerplate.
- 4 audible and visual signal inputs.
- Modulated frequency sound emission with sound options.
- High output magnetodynamic exponential horn with test circuit.
- Protected against tamper, wall tamper, flash bulb damage and wire cutting.
- Foam tamper device (**NEKA-F** and **NEKA-FS** only).
- Programmable maximum alarm time.
- Battery test circuit with flash shutdown under low battery or battery trouble conditions (**NEKA** and **NEKA-F** only).
- Drilling pattern for easy installation.
- Houses 12 V, 2 Ah, buffer battery.

Box

The hard wearing plastic moulding is resistant to the most adverse weather conditions. The louver grille has been especially designed to protect the internal components against rain while epitomising sound emission. The tropicalized-steel innerplate provides extra protection against acts of delinquency.

Tamper protection

The tamper device (must be anchored to the wall) triggers alarms when either the frontplate or innerplate is removed, or when the siren is pulled from the wall (wall tamper). The foam tamper protection (**NEKA-F** and **NEKA-FS** only) comprises an active infrared barrier with a dual detector that provides high immunity to false alarms (caused by insects).

The siren can operate in normal or automatic mode. In normal mode, the siren opens the **AS** and **ASG** terminals when tampered. These terminals have to be connected to control panel tamper line that activates the siren (and other types of signalling, depending on requirements) through **+N**, **AF**, **A** or **F** terminals.

In automatic mode, the siren independently activates the acoustic and optical signalling for tamper events: **AS** and **ASG** terminals do not need to be connected to tamper line but the control panel do not know the siren tamper status. In automatic mode, the tamper alarm ends when 40 seconds after all causes have been removed, or when maximum alarm time elapses.

Activation

The siren can be activated by the tamper device, and by **+N**, **AF**, **A** and **F** terminals. For example: the siren activates when the voltage fails on terminal **+N**. This operating mode allows the siren to detect wire cutting, as this terminal also supplies the power and battery charge. The polarity programmable **AF**, **A** and **F** terminals can be used for connection to other devices.

 *The siren blocks for 4 minutes if receive most then 6 activating requests in 4 minutes. This is to protect against control panel malfunctioning.*

Signalling

The audible and visual signals on the loudspeaker and strobe/flash depend on the type of alarm, and the alarm signal configuration. The sound modulation extremes generate a fastidious shrill tone — intended to discourage intruders, and a low tone — to ensure good audibility. It is possible to select two audible signals patterns for alarm Inputs — with the exception of the internal tamper event which has only one audible signal (up-scale modulated frequency between 800 and 2000 Hz). The audible signals and modulated frequency range can be found in “Setting the operating mode” on page 7. There are two frequency ranges: 800/2000 Hz and 1100/2400 Hz. The audible signalling will stop as soon as the maximum alarm time expires, whereas, the visual signalling will continue until the alarm conditions clear (memory flashing).

The Memory and Alarm flash sequences are as follows:

NEKA/NEKA-F	ON (ms)	OFF (ms)	Description
Alarm flashing	250	750	Standard Blink
Memory flashing	250	1500	Slow Blink

NEKA-FS	Frequency (Hz)	Description
Alarm flashing	1	Standard Blink
Memory flashing	0.6	Slow Blink

Under low battery conditions, the siren bypasses the flash and use the residual charge to power the loudspeaker (**NEKA** and **NEKA-F** only). This status is signalled on terminal **G** (**NEKA** and **NEKA-F** only). This terminal (open collector) is connected to ground during standby status, but disconnects in the event of low battery (**NEKA** and **NEKA-F** only), or damage to the loudspeaker or flash.

P S T When **S** and **T**'s pins are connected as shown at the side, siren activation is inhibit and the siren displays the troubles as following.



- **No Trouble:** the loudspeaker emits an acoustic signal and the flash blinks once.
- **Battery trouble:** the loudspeaker emits two acoustic signal and, if battery charge is sufficient, the flash blinks twice.
- **Flash trouble:** the loudspeaker emits three acoustic signal.
- **Loudspeaker trouble:** the flash blinks four times.

The above listed signalling are displayed every 5 seconds until troubles are present or the jumper is removed. The siren runs the power-up sequence when the jumper is removed.

🔊 If troubles are not present, the inhibition of siren activation is delayed between 30 seconds and 2 minutes, to prevent this function being used to tamper the siren.

🔊 In this phase, anti-foam device can be tested as **FT** output activates as soon as the infrared barrier of the device is interrupted (**NEKA-F** and **NEKA-FS** only).

Alarm priority

The siren priority is as follows:

Alarm	Priority
Internal tamper	1
+N	2
AF	3
A	4
F	4

Higher priority alarm always overrides lower priority alarm, generating a variation in the audible signal.

🔊 **A** and **F** terminals have the same priority because the acoustic signalling activated by terminal **A** does not interfere with the optical signalling activated by terminal **F**.

The alarm time is counted from activation of the loudspeaker and strobe/flash.

When the maximum alarm time of the higher priority alarm expires, or when the alarm conditions clear, the lower priority alarm signal activates the loudspeaker and strobe/flash in accordance with its configuration.

If a priority alarm signal overrides an alarm that has been running for more than 30 seconds, the maximum alarm time of the interrupted signal will run on.

If the priority alarm terminates (due to timeout or restoral) before the maximum alarm time of the interrupted signal expires, the latter activates the loudspeaker and strobe/flash for the residual time.

If a priority alarm signal overrides an alarm that has been running for less than 30 seconds, the maximum alarm time of the interrupted signal will freeze. If the interrupted alarm signal is still present when the priority alarm terminates (due to timeout or restoral), it activates the loudspeaker and strobe/flash in accordance with its configuration. If the interrupted alarm signal has restored when the priority alarm terminates (due to timeout or restoral), it activates the loudspeaker and strobe/flash for 30 seconds. Figure 2 shows how the lower priority alarm signal **A** activates the horn and strobe/flash after the higher priority alarm (alarm signal **+N**) has been executed.

Memory flashing will stop (after the maximum alarm-time) when all the signals, that triggered the alarm, restore to standby for 5 seconds (restoral time). Internal tamper restoral requires 40 seconds.

Figure 2 shows an example on how signalling devices (optical and acoustic) work for a particular activation sequence.

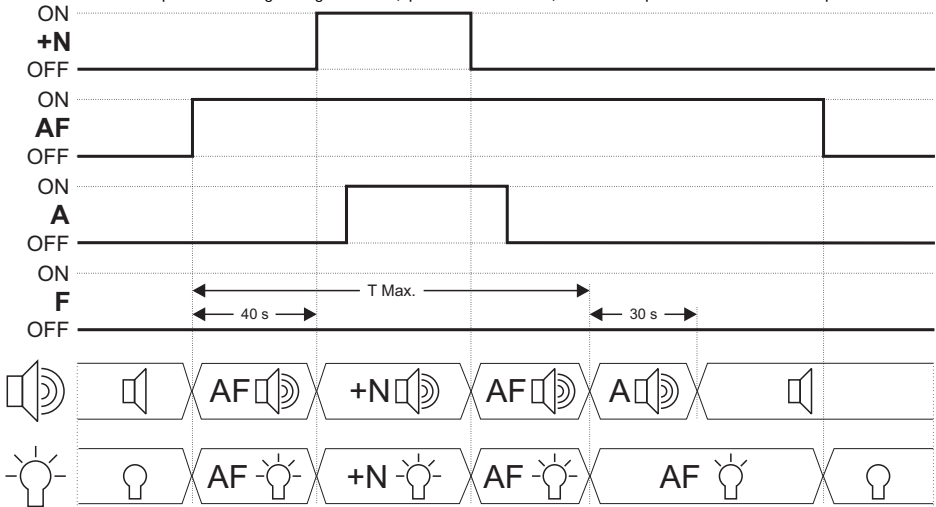

Figure 2 – Alarm priority:  standard flashing:  memory flashing.

Setting the operating mode

If you are installing several sirens in the same area, the jumpers on the electronic board allow to select different sound for each one, thus permitting users to distinguish between them. You can also select different sounds for different alarm types (gas leak, burglary, flooding, etc.) or locations (office, warehouse, garage, etc.). This feature allows users to recognize the alarm type and its location. Jumpers **S** allows to select the sounds for inputs **+N**, **AF** and **A**. Other jumpers allow to set the maximum alarm time, the input polarity and internal tamper mode. For the various programming options provides by the jumpers refer to table 2 (first column shows the default). For the frequency profile of the audible signals refer to "Available sounds" on page 15.













Maximum alarm time			
T 	10 minutes	T 	3 minutes
Alarm sound			
S 	Tamper (automatic mode): Up scale modulation LF . +N : Up and down scale modulation (LF). AF : Up and down scale modulation (HF). A : Multitone HF .	S 	Tamper (automatic mode): Up scale modulation LF . +N : Up and down scale modulation (HF). AF : Up scale modulation HF . A : Up and down scale modulation LF .
AF, A and F input activation polarity			
P 	Inputs on standby when disconnected. Inputs activate when connected to negative.	P 	Inputs on standby when connected to negative. Inputs activate when disconnected.  <i>If this option is selected, not used inputs must be connected to / terminal.</i>
Trouble signalling			
		P S T 	Trouble signalling ON (test mode): alarm activation is inhibited.
Tamper mode			
AUT NOR 	Automatic mode: automatic activation of the siren for tamper.	AUT NOR 	Normal mode: the siren must be connected to the control panel tamper line.
Foam-tamper mode (NEKA-F/NEKA-FS only)			
	Foam tamper generates a tamper alarm like siren opening and siren wall removal.		Foam tamper generates an alarm independent from siren opening and siren wall removal.

Table 2 – Jumper description. **HF** and **LF** indicate the sound frequency range: **HF** = 1100/2400 Hz, **LF** = 800/2000 Hz.

Mounting

The siren should be mounted as high up as possible on a flat wall, as uneven surfaces may jeopardize proper functioning of wall-tamper protection.

To facilitate the mounting operation, a drilling pattern and screws for fixing are in the package. On the drilling pattern are drawn 5 holes, corresponding to those of fixing, placed on the bottom of the siren.

Proceed as described below (see figure 1 on page 3).

☞ *Make sure that the strobe flash is connected before powering the siren, otherwise the flash may not work properly (NEKA-FS only).*

1. Place the drilling pattern on the wall with PC opening over the wiring cable: make sure the drilling pattern is horizontal.
2. Mark the anchor screw holes F1, F2, F3, F4 e F5.

☞ *Make sure to mark the upper side of F2 hole.*

3. Mark the wall-tamper anchor screw hole F6.
4. Take off the drilling pattern.
5. Drill the marked holes.
6. Insert the wall plugs in the holes.
7. Screw a screw into hole F2 up to a distance of about 1 cm from the wall.
8. Pull the wires through the cable entry 12 and hang the siren through the hole 21.
9. Fix the siren permanently through the holes 11.
10. Fix the wall-tamper plate through the hole 16, without tightening the screw too much in order not to break the stop tabs.
11. Set the siren operating mode by means of the jumpers 6 and 7 and make the connections on the terminal board 9.
12. Place the battery on shelf 19 and then connect it to connector 3 (BATT) via cable 20: the flash starts to blink in alarm memory mode (slow blink).

☞ *Tamper protection is not active until the cover and the inner-cover of the siren are closed, and until the +N terminal is powered for at least 20 seconds.*

☞ *The foam tamper device can be tested in this phase because FT output activates as soon as the device infrared barrier is interrupted (NEKA-F and NEKA-FS only).*

13. Put in place the inner cover and fix it by means the screws 1.

⚠ *Be careful not to cause a short circuit by touching the flash contacts.*

14. Put in place the cover and fix it by means the screws 2: the flash blinks in alarm mode for 20 seconds (standard blink).

☞ *If the cover or inner cover is removed, the 20 seconds reset and the flash restart to blink in alarm memory mode (step 12).*

15. Apply the voltage on +N terminal: the siren becomes operational when 20 seconds have elapsed from the +N power supply.

☞ *If the voltage on +N terminal fails before 20 seconds have elapsed, the 20 seconds reset and the flash continues to blink in alarm mode (step 14).*

Wiring







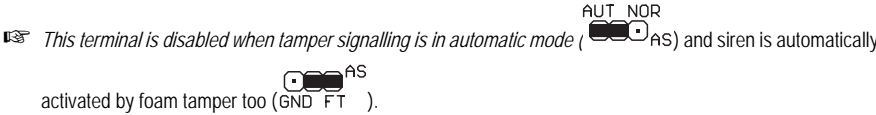

T.	Description
SPK	Loudspeaker connection terminals.
AS ASG	Tamper signalling terminals: when tamper signalling is set to normal mode, these terminals open when the cover or innerplate is removed, or when siren is pulled from the wall, or when the foam tamper is detected (NEKA-F and NEKA-FS only).
FT	<p>Foam tamper signalling terminal (NEKA-F and NEKA-FS only): open-collector normally closed to ground, it opens when at least 30 seconds has been elapsed from interruption of the device infrared barrier.</p> <p> This terminal is disabled when tamper signalling is in automatic mode (  AS) and siren is automatically activated by foam tamper too (  AS (  FT)).</p>
G	Trouble signal terminal: open-collector normally closed to ground, opens for low battery and battery trouble (NEKA and NEKA-F only), loudspeaker trouble, flash bulb damage (strobe board not present).
F	Alarm activation terminal with programmable polarity (optical signalling only).
A	Alarm activation terminal with programmable polarity (acoustic signalling only).
AF	Acoustic and optical signalling activation terminal, with programmable polarity.
+N	Power supply (positive) and alarm terminal. 13.8 V must be applied to this terminal for the battery charge. If this voltage fails (wire cutting or alarm) the siren go into alarm status (acoustic and optical signalling).
	Negative supply terminal and ground of the internal circuit. 

Table 3 – Terminal description.

 Use shielded cable only, with one end connected to the control panel negative and the other left free.

Automatic mode

For siren basic operation are required two wires only, as shown in figure 3: the control panel (A) must have a terminal (+N) where 13.8 V voltage (minimum 600 mA) is present on standby and no voltage in alarm; the control panel cannot detect the siren tamper, and foam tamper (NEKA-F and NEKA-FS only) but the siren automatically activates for those events.

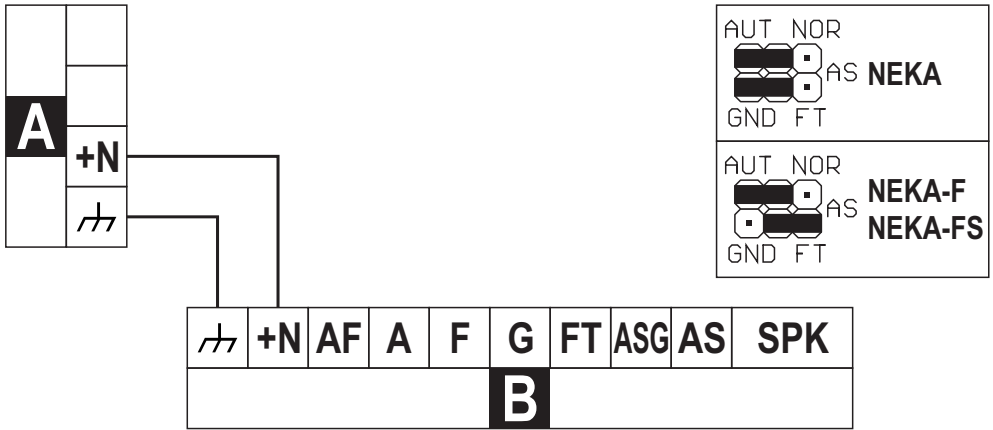

Figure 3 – Automatic mode: A) control panel; B) siren.

Automatic mode with independent management of foam tamper (NEKA-F/NEKA-FS only)

If foam tamper have to be managed by the control panel, jumpers position must be as shown in figure 4, and FT terminal of the siren (B) must be connected to an input line of the control panel (A) that is on standby when connected to ground and in alarm when floating (Z terminal in the figure).

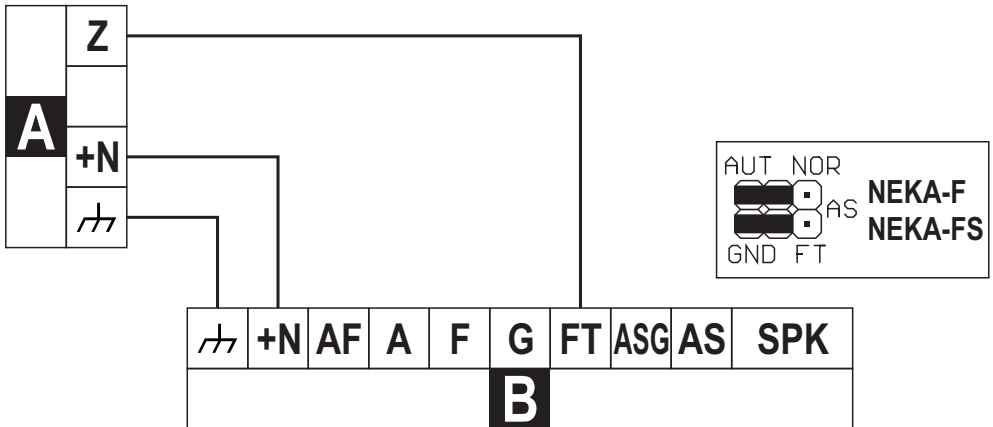

Figure 4 – Automatic mode with independent management of foam tamper: A) control panel; B) siren.

Normal mode

If siren tamper, and foam tamper (**NEKA-F/NEKA-FS** only) have to be managed by the control panel, jumpers position must be as shown in figure 5, and **AS** terminal of the siren must be connected to the tamper line of the latest device: in this operating mode, **AS** terminal of the siren is normally connected to the ground while is open for siren tamper or foam tamper.

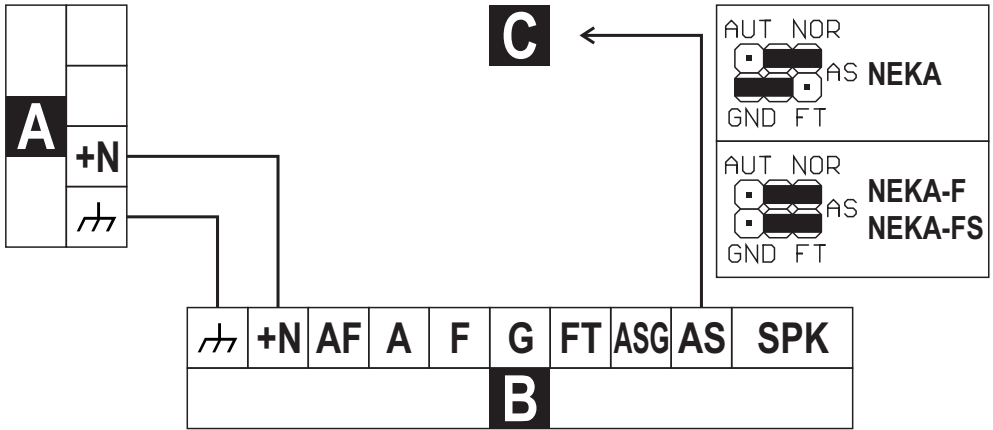

Figure 5 – Normal mode: A) control panel; B) siren; C) to second-last device on tamper line.

Normal mode with independent management of foam tamper (**NEKA-F/NEKA-FS** only)

If foam tamper have to managed by control panel independently from the siren tamper, jumper positions must be as shown in figure 6, and **FT** terminal of the siren (**B**) must be connected to an input line of the control panel (**A**) that is on standby when connected to ground and in alarm when floating (**Z** terminal in the figure).

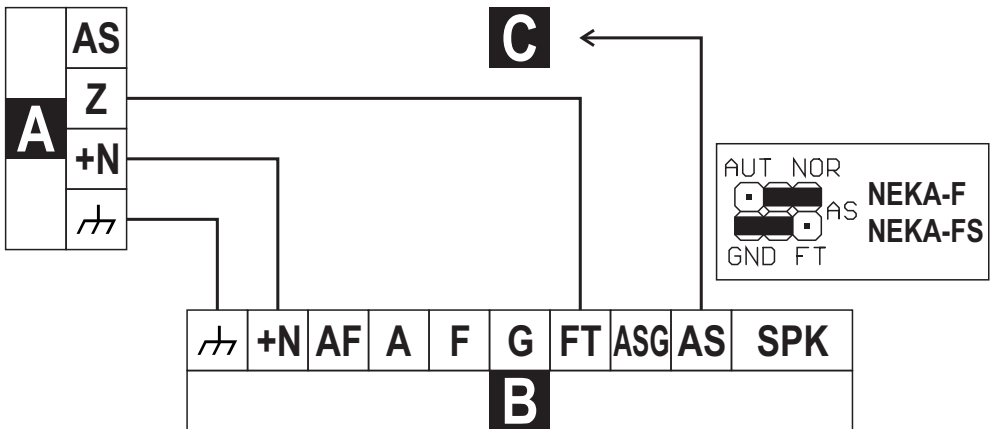

Figure 6 – Normal mode with independent management of foam tamper: A) control panel; B) siren; C) to second-last device on tamper line.

Normal mode when the siren is not latest device on tamper line

If the siren is not the latest device on tamper line, jumper position must be as shown in figure 7, and **ASG** and **AS** terminals of the siren must be series connected to the tamper line: **ASG** and **AS** terminals of the siren are normally connected, and disconnect for siren tamper. The **FT** terminal have to be connected for **NEKA-F/NEKA-FS** sirens only.

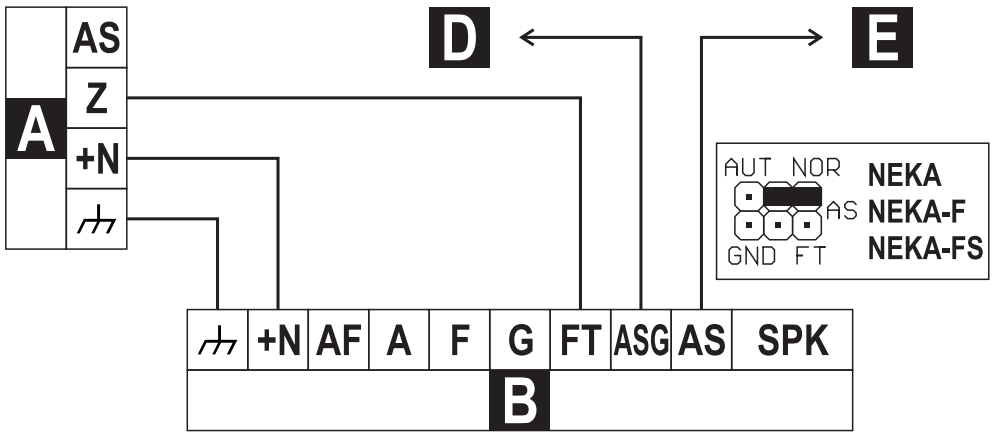

Figure 7 – Normal mode when the siren is not latest device on tamper line: **A)** control panel; **B)** siren; **D)** to previous device on tamper line; **E)** to next device on tamper line.

Other modes for siren activation

If the control panel do not have a terminal where 13.8 V voltage is present on standby, and no voltage in alarm, it is possible to simulate one by means of the free-voltage contacts of alarm relay, as shown in figure 8.

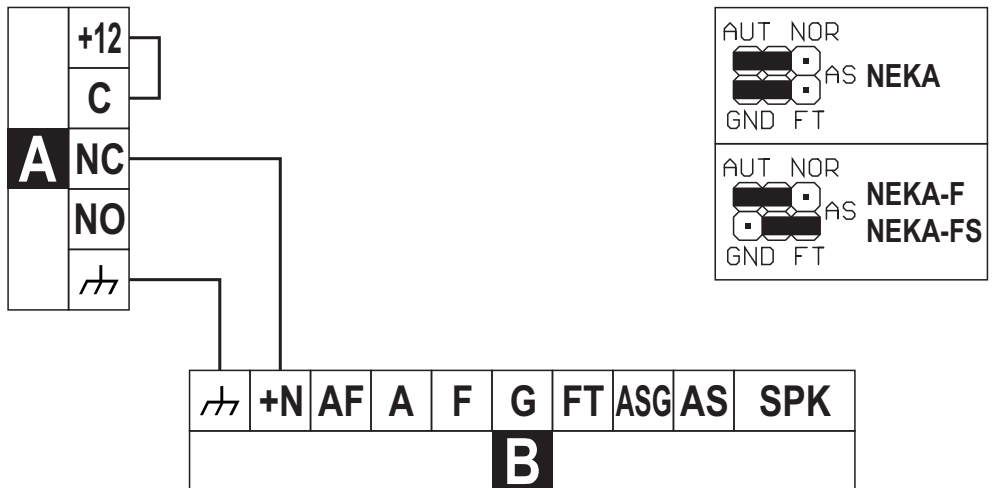

Figure 8 – Activation by means of the free-voltage contacts of alarm relay: **A)** control panel; **B)** siren.

Figures 9 and 10 show, instead, wiring to activate the siren by means an open-collector output (the **OC** terminal of the control panel **A**): **P** jumper must be inserted if the **OC** output closes to ground on alarm, must be removed if **OC** output opens on alarm. On + terminal of the control panel 13.8 V voltage (minimum 600 mA) must be present for siren power supply, and siren battery charging.

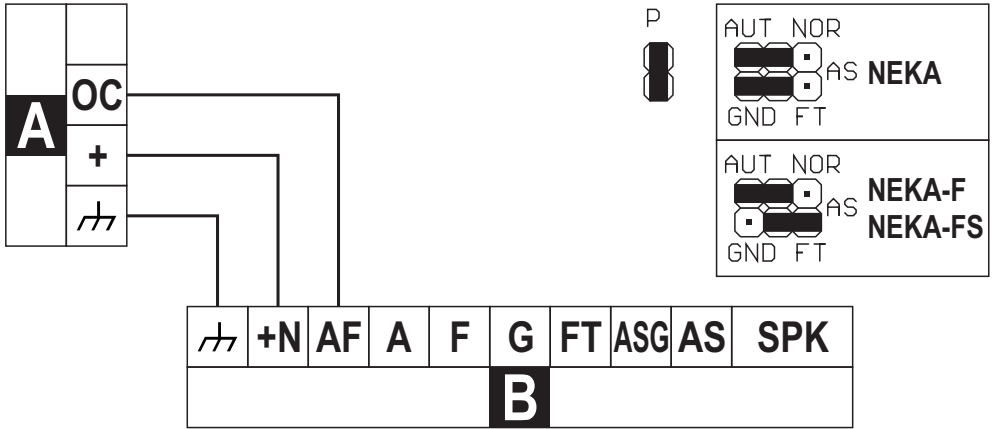

Figure 9 – Wiring to activate the siren by means an open-collector output that closes to ground on alarm: **A**) control panel; **B**) siren.

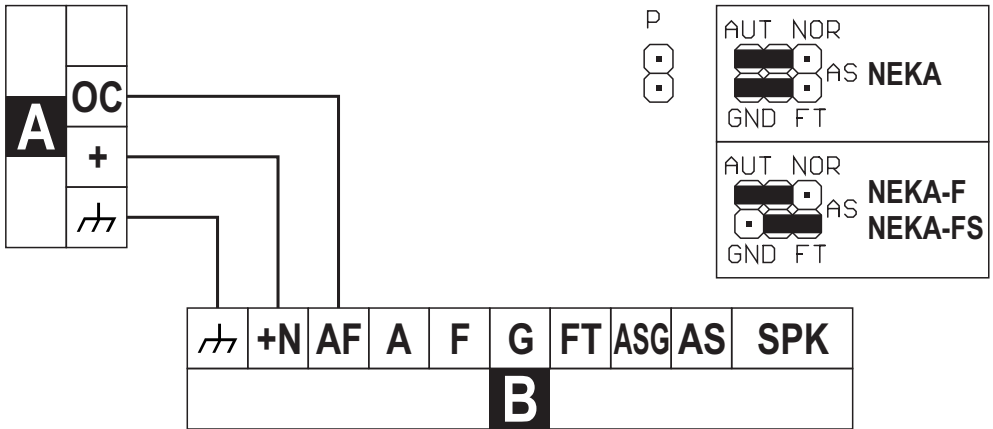

Figure 10 – Wiring to activate the siren by means an open-collector output that opens on alarm: **A**) control panel; **B**) siren.

🔊 Acoustic signalling activation by means the **A** terminal and optical signalling activation by means the **F** terminal can be done in the same way.

Trouble shooting

Problem	Cause	Solution
The battery is connected but the flash does not function.	The battery may be low.	Replace the battery.
Continuous flashing and/or continuous sound on the loudspeaker.	1) The wall-tamper device is not secured properly. 2) The cover or the metal innerplate is not closed properly.	Eliminate the causes.
The loudspeaker sounds but the flash does not function.	1) The battery may be low. 2) The flash may be out-of-order.	1) Replace the battery if necessary. 2) Change the flash bulb or call the installer.
The flash functions but the loudspeaker is silent.	1) More than the maximum alarm-time has elapsed since the start of audible signalling. 2) The loudspeaker is out-of-order. 3) The siren has been activated more than six times in 4 minutes.	1) Eliminate the causes of alarm. 2) Call the installer. 3) Wait 4 minutes with no siren activation.
It is impossible to activate the siren.	1) The installation-time has not expired. 2) The battery is low.	1) Wait 20 seconds. 2) Replace the battery if necessary.

Table 4 – Trouble shooting.

Technical specifications

Nominal voltage: 13.8 V $\overline{=}$

Alarm current: 1.4 A (max 2.8 A)

Voltage on terminal +N: 13.8 V \pm 0.2 V

Current on terminal +N: max 0.6 A

Minimum (maximum) supply voltage: 10 V $\overline{=}$ (13.8 V $\overline{=}$)

Battery requirements: 2 Ah (177x34x66 mm)

Maximum alarm-time (programmable): 3 / 10 minutes

Protection class: IP34

Temperature range: -25 – +55 C°

Dimensions (WxHxD): 208x252x98 mm

Weight (without battery): 2300 g

Available sounds

Type of sound		Frequencies	Period	Sound level at 3 m
Multitone		1108 Hz for 200 mS 1244 Hz for 180 mS 1396 Hz for 150 mS 1567 Hz for 145 mS 1760 Hz for 110 mS 2123 Hz for 100 mS 2430 Hz for 90 mS	0.3 s	106 dB(A)
Up scale modulation (LF)		800 - 2000 Hz	0.3 s	104 dB(A)
Up scale modulation (HF)		1100 - 2400 Hz		105 dB(A)
Up and down scale modulation (LF)		800 - 2000 Hz	0.6 s	104 dB(A)
Up and down scale modulation (HF)		1100 - 2400 Hz		105 dB(A)

Table 5 – Available sounds.

Compliance with standards

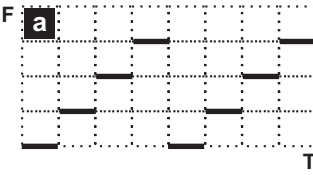
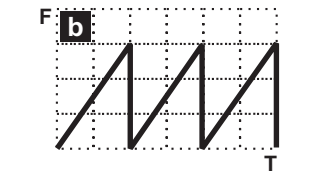
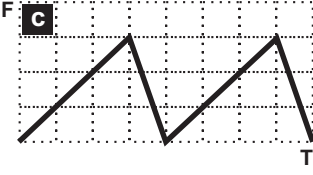

Hereby Bentel Security Srl declares that the product **NEKA/NEKA-F/NEKA-FS** complies with standards EN 60950, EN 61000-6-3, EN 50130-4 and thereby, complies with the essential requirement of directives 2014/35/EU, 2014/30/EU and 2011/65/EU.

Recycling information

BENTEL SECURITY recommends that customers dispose of their used equipment (panels, detectors, sirens and other devices) in an environmentally sound manner. Potential methods include reuse of parts or whole products and recycling of products, components, and/or materials.

For specific information see www.bentelsecurity.com/index.php?o=/environment.htm.

Waste electrical and electronic equipment (WEEE) directive



In the European Union, this label indicates that this product should NOT be disposed of with household waste. It should be deposited at an appropriate facility to enable recovery and recycling.



For specific information see www.bentelsecurity.com/index.php?o= environment.htm.

The manufacturer reserves the right to change the technical specifications of this product without prior notice.



BENTEL SECURITY s.r.l. – Via Gabbiano, 22 – Z. Ind. S. Scolastica – Corropoli (TE) – Italy – tel.: +39 0861 839060

Fax: +39 0861 839065 – infobentelsecurity@tycoint.com – www.bentelsecurity.com

ISTISBLENEKA 1.0 270219 FM10